

Infrico



Catálogo General 20
General Catalogue 24
Catalogue Général 24

Válido para todo el catálogo:

Precios válidos salvo error tipográfico o cambio de tarifa /

Etiqueta energética disponible en las fichas técnicas de producto en nuestra web infrico.com /

Fotografías no contractuales /

Características técnicas y constructivas sujetas a variación sin previo aviso /

Los datos técnicos están sujetos a posibles variaciones que serán actualizadas periódicamente en las fichas técnicas del producto, disponibles en la web.

Valid for the entire product guide:

Prices valid except in the case of typographical error or change of price list /

Energy label available in the product data sheets on our website infrico.com /

Non contractual pictures /

We reserve the right to change specifications without prior notice /

The technical data are subject to possible variations that will be updated periodically in the technical data sheets of the product, which are available on the website.

Valable pour tout le catalogue:

Prix valables sauf en cas d'erreur typographique ou de changement de tarif.

Étiquette énergétique disponible dans les fiches produits sur notre site infrico.com /

Photos non contractuelles /

Les caractéristiques techniques et la conception peuvent être sujettes à modifications, sans préavis /

Les données techniques peuvent varier et seront actualisées dans les fiches techniques du produit, disponibles sur le site web.

Infrico S. L. 2024

GRUPO Infrico®



INFRICO nace en 1986 con un objetivo claro: generar las mejores soluciones de refrigeración adaptadas a las necesidades específicas de cada cliente. **Vanguardia tecnológica, calidad certificada y la excelencia de sus productos son las garantías** que avalan su compromiso de innovación y que la han posicionado como líderes absolutos en el sector del equipamiento del frío comercial.

La empresa ofrece una muy amplia gama de maquinaria que abarca todo lo relacionado con el frío para el sector **HORECA**, panadería, pastelería, heladería, catering y también **Supermarket**, mediante su línea específica,

INFRICO was born in 1986 with a clear objective: to generate the best cooling solutions adapted to the specific needs of each client. **Technological vanguard, certified quality and the excellence of its products are the guarantees** to support its commitment to innovation and that have positioned it as absolute leaders in the commercial refrigeration equipment. The company offers a very wide range of machinery that covers everything related to cold for the **HORECA** sector, bakery, pastry, ice cream, catering and also **Supermarket**, through its specific line, thanks to cold. Also,

INFRICO est un fabricant espagnol leader dans la production d'équipement de réfrigération commerciale. **Technologie de pointe et qualité certifiée sont les garanties** sur lesquelles est fondé notre engagement d'innovation: élaborer les meilleures idées et solutions pour chacun de nos clients.

a través del frío. También el sector biomédico y de laboratorio con su prestigiosa línea **Infrico Medcare**.

Con clientes en todo el mundo y una gran cuota de mercado nacional, la compañía, que se encuentra en un continuo proceso de crecimiento y expansión, cuenta en la actualidad con más de quinientos empleados repartidos en 13 delegaciones en España y 16 en el extranjero. Además, en una firme apuesta por la estabilidad y el bienestar social, más del 90% de los trabajadores son empleados fijos.

Infrico posee el Certificado de **Origen Español Certificado** (O.E.C.) que acredita

the biomedical and laboratory sector, with its prestigious **Infrico Medcare** line.

It has customers around the world and a large share of the national market, the company, which is in a continuous process of growth and expansion, currently has more than five hundred employees spread across 13 delegations in Spain and 16 abroad. In addition, in a firm commitment to stability and social welfare, more than 90% of workers are permanent employees.

The company has **Spanish Origin Certificate** (S.O.C.) that certifies that its products are man-

L'entreprise se situe parmi les entreprises leaders du secteur, avec une position très avantageuse par rapport à ses concurrents quant au volume de marché et à sa présence sur le territoire français.

Avec 13 délégations sur le territoire espagnol et 16 à l'étranger, Infrico répond aux

que sus productos son fabricados en España, convirtiéndose así en la primera compañía del sector que logra este sello en nuestro país, tras superar con éxito su exhaustivo proceso de auditoría.

Sus centros de producción ubicados en Lucena, en la provincia de Córdoba, son unas de las instalaciones industriales más modernas de España. Tres plantas, Infrico, Infrico Supermarket e Impafri, que cuentan con una superficie total de **160.000 metros cuadrados** destinados a producción, actividades logísticas y oficinas.

ufactured in Spain, thus becoming the first company in this sector in Spain to achieve this seal after successfully completing its exhaustive audit process.

The Production Centers are located in Lucena, in the province of Cordoba, they are one of the most modern industrial facilities in Spain. Three plants that have a total area of **160.000 square meters** for production, logistics activities and offices.

besoins de ses clients de manière proche et en temps opportun, avec un système de production flexible et efficace.

Infrico dispose de trois centres de production, Infrico, Impafri et Infrico supermarket avec une superficie totale de **160.000 m2 dont 60.000 m2** dédiés à la fabrication.

INDICE DEX DEX

00
NOVEDADES
NEWS
NOUVELLES

01
ENFRIADORES
BOTTLE COOLERS
REFROIDISSEURS

02
MESAS
UNDERCOUNTERS
TABLES

05
LÍNEA AMERICANA
AMERICAN LINE
LIGNE AMERICAINE

03
ARMARIOS
REACH INS
ARMOIRES

04
ABATIDORES
BLAST CHILLERS
& FREEZERS
CELLULES DE
REFROIDISSEMENT

06
INFRICOOOL



07
CAVAS & DRY AGING



08 VITRINAS EXPOSITORAS
DYSPLAY CASES
VITRINES DE PRÉSENTATION



09 MURALES
MULTIDECKS
VITRINES MURALES



11 VITRINAS DE HELADERÍA-PASTELERÍA
PASTRY - GELATO DISPLAY CASES
VITRINES PÂTISSIÈRES



10
SUPERMARKET



12
MAQUINARIA HOSTELERÍA
HORECA EQUIPMENT
NEGOCE

Delegaciones / Delegations / Délégations

1 - Oficina Central / Main Office / Usine de fabrication

INFRICO S. L. Ctra. de Aguilar a A-318 por Moriles, Km 15,5 - A-3132
CP 14900 Lucena, Córdoba - España

☎ +34 957 51 30 68

☎ +34 957 59 11 83

✉ info@infrico.com

1 - JEFE DE VENTAS

Luis Rivas Montalvo

☎ 650 43 65 87

✉ luisrivas@infrico.com

2 - MADRID Y ZONA CENTRO

Javier López / Alberto Moreno / José Castellanos

☎ 682 68 21 25 / 627 75 22 38 / 666 41 92 41

☎ 91 684 60 96

☎ 91 684 61 06

✉ delegacioncentro@infrico.com

3 - CATALUÑA-ANDORRA

Raúl Ballano / M^a. José Verdú / Nacho Garat

ITECNIC, S.L.

☎ 670 84 44 56 / 689 33 20 25 / 682 36 44 66

☎ 93 562 61 52

☎ 93 562 61 45

✉ info@itecnic.com

4 - CANARIAS

Carlos Vega

DICAFRI, S.L.

☎ 674 88 30 40

☎ 928 70 10 87

☎ 928 70 10 85

✉ comercial.dicafri@infrico.com

5 - SEVILLA, HUELVA Y CÁDIZ

José Manuel Romana

☎ 654 50 98 40

✉ josemanueldibeca@hotmail.com

6 - CÓRDOBA, JAÉN, MÁLAGA CEUTA, MELILLA

Miguel Cantero

☎ 620 29 82 82

✉ miguelcantero@infrico.com

7 - GRANADA, ALMERÍA Y MURCIA

Daniel Riquelme Cordero

☎ 659 85 04 15

✉ danielriquelmecordero@hotmail.com

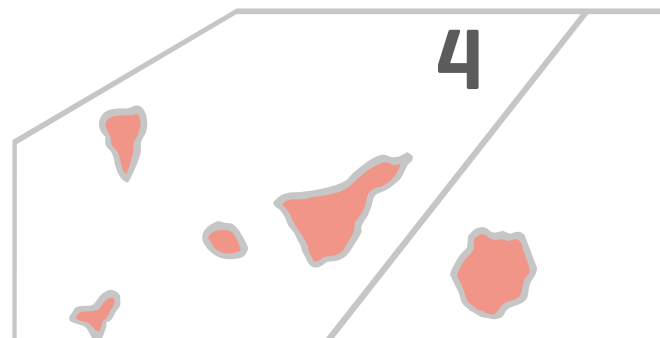
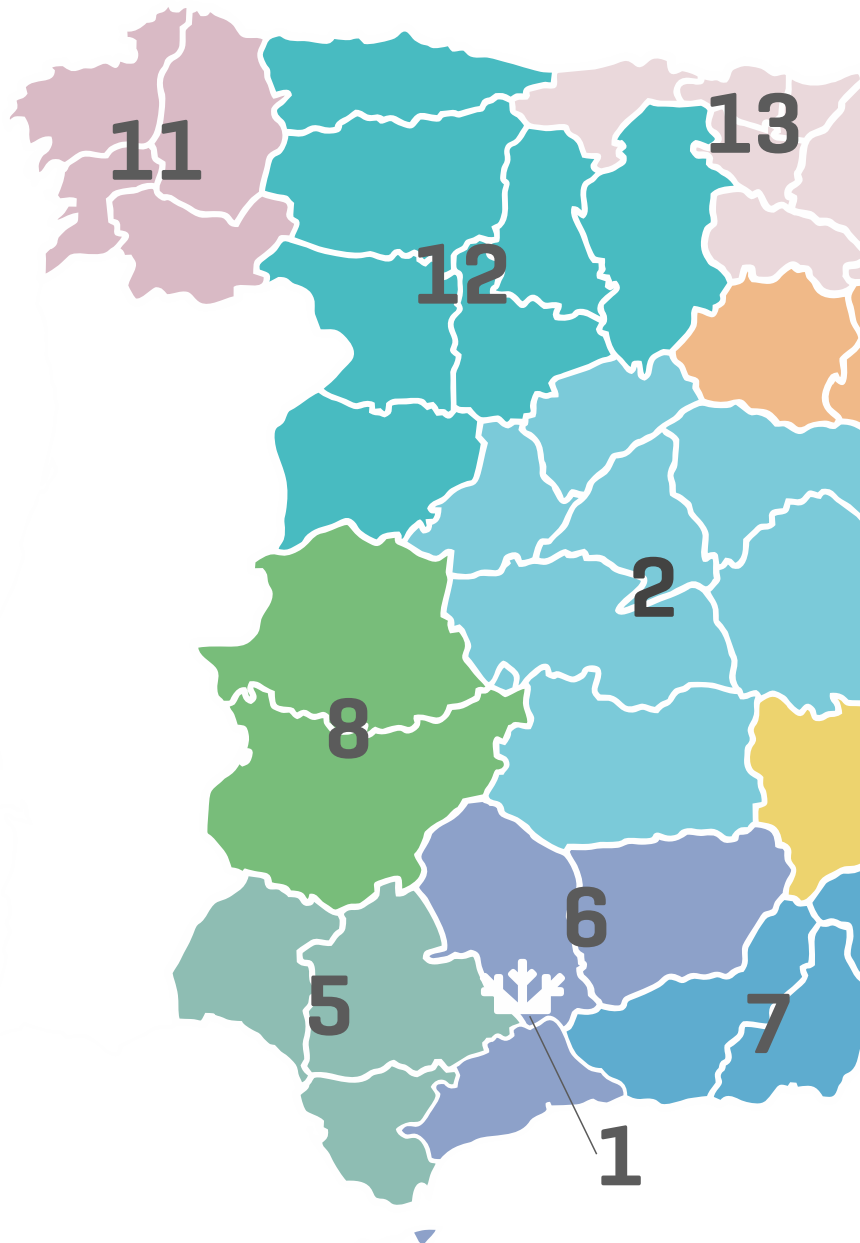

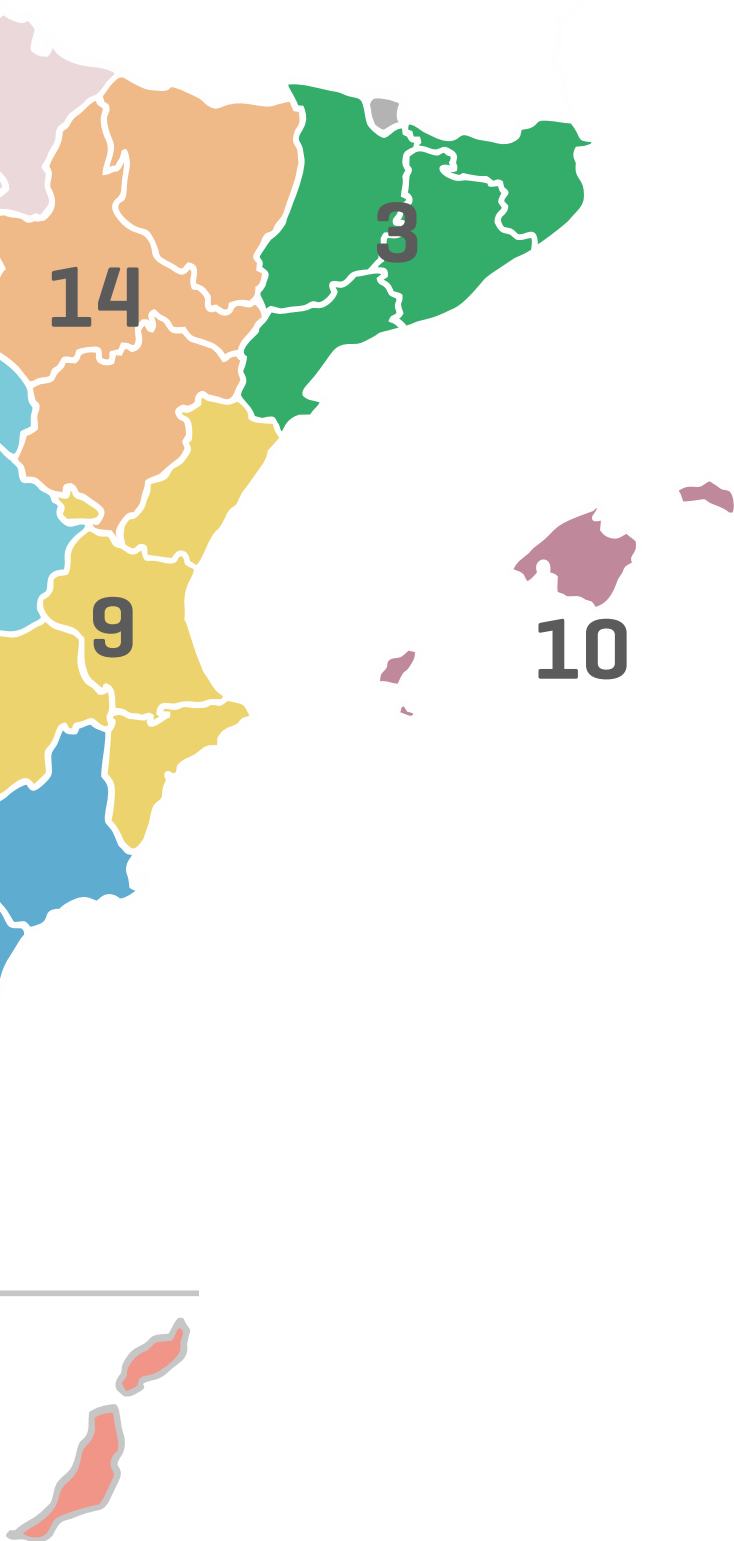
**8 - EXTREMADURA****Manuel Pérez Guisado**

☎ 670 03 23 56

☎ 924 45 61 91

✉ manuel@representacionessmpg.com**9 - VALENCIA, ALICANTE, CASTELLÓN Y ALBACETE****Victoria Oliver / Elena Oliver**

SILVINO OLIVER, S.L.

☎ 963 97 02 45

☎ 605 09 75 40

☎ 963 97 02 46

✉ infricovalencia@silvinooliver.com**10 - BALEARES****Manuel Castro Baños**

☎ 628 67 18 97

✉ mcastro@infrico.com**11 - GALICIA****Juan José Espejo / Brais Espejo**

☎ 609 85 01 55 / 691 11 72 35

✉ escohostel@escohostel.com**12 - CASTILLA-LEÓN Y ASTURIAS****Paulino Canga González**

☎ 609 66 52 54

☎ 670 59 49 86

✉ paulo@delegadoastur.com**13 - PAÍS VASCO, NAVARRA, LA RIOJA Y CANTABRIA****Mikel Pérez De Viñaspre**

☎ 650 25 56 34

✉ mikelperez@infrico.com**14 - ARAGÓN****Adolfo Bueno**

☎ 653 85 70 60

✉ buenozaragoza@gmail.com



SALES MANAGER

Fran Ramón

☎ +34 609 21 81 94

✉ framon@infrico.com

INFRICO FRANCE / ITALY

Roberto Doval

☎ +34 606 970 357

✉ rdoval@infrico.com

IRELAND

Carlos Ortega

☎ +34 669 65 99 01

✉ cortega@infrico.com

PORTUGAL

Rui Vigo

Unipessoal Lda. Rui Vigo

☎ + 351 915 283 253

☎ + 351 309 955 122

✉ rui.vigo@netcabo.pt

UK / BENELUX

Mark Botwright

☎ +34 679 71 93 26

✉ mark@infrico.com

NORTH EUROPE

Rafael Cañada

☎ +34 630 44 79 29

✉ rafael@infrico.com

CENTRAL / EAST EUROPE

Dragan Cerkez

☎ +34 608 808 971

✉ dragan@infrico.com

SUIZA / SWITZERLAND

Remzi Alili

Resan Enfrico Sàrl

☎ + 41 79 589 32 01

☎ + 41 21 671 70 70

✉ resanenfrico@resanenfrico.ch

INFRICO MAROC / ÁFRICA / ARABIA SAUDI

Aziz Bouhartan

☎ + 212 661 107 372

☎ + 212 522 207 372

✉ aziz.bouhartan@infrico.com

SOUTHAFRICA

Culinary

☎ +27 0 11 701 2200

✉ info@culinary.co.za

TURKEY / CENTRAL ASIA

Dogan Bademkiran

☎ + 90 545 583 6315

✉ dogan@infrico.com

MIDDLE EAST / INDIA SUB / EGIPT

Sushil Hiranandani

☎ +971528 496385

✉ middle-east@infrico.com

ASIA-PACIFIC

Rafael Pérez

☎ +34 620 000 938

✉ rperez@infrico.com

**NORTH AMERICA****Pedro Carvajal**

☎ +34 690 23 44 78

✉ pcarvajal@infrico.com**INFRICO USA****Juan Pablo Esparragoza**

☎ 1.855.340.4637

✉ sales@infrico.com**USA****Carlos Ortega Doval**

☎ +34 669 65 99 01

✉ cortega@infrico.com**CANADA****Axom Group****Eastern: Xavier Lavigne**

☎ +1 514 825 2966

✉ xavier@axomgroup.ca**Western: Christiaan van den Hoven**

☎ +1 604 889 2966

✉ chris@axomgroup.ca**MÉXICO****Francisco Pedroche**

Sinergias

☎ +33 3630 4547 / +33 3615 7926

✉ ventas@sinergiasmx.com**LATINOAMÉRICA****Antonio Mendoza**

☎ +34 682 65 57 84

✉ amendoza@infrico.com**REPÚBLICA DOMINICANA****Rafael Podadera**

Parlyn International

☎ + 18097594424

✉ rpodadera@parlyninternational.com**PUERTO RICO****Alexandre Vargas**

Global Kitchen Solutions

☎ +1 787 923 9365

✉ alexandre@globalkitchensolutions.com**PANAMA****Juan Gabriel Martinez**

☎ +507 6676 8092

✉ jmartinez@equipcopanama.com**COLOMBIA****Fernando Toro**

☎ +57 313 452 1306

✉ ftoro@infrico.com**ECUADOR / PERÚ / BOLIVIA****Giovanni Pedrazzoli**

☎ +59 399 118 6962

✉ gpedrazzoli@infrico.com**CHILE****Josué Meléndez**

Comercial Maquinet

☎ Tel.: +56 98199 3973

✉ ventas@maquinet.cl

Délégations France

infrico.fr 📍 ZAC des Portes d'Océane OUEST. 72650 SAINT SATURNIN (FRANCE)

☎ 02 43 42 00 33

📠 02 43 42 28 07

Direction

Roberto Doval:

☎ +34 606 97 03 57

✉ rdoval@infrico.com

Direction

Commerciale

Jerome Crespel

☎ 06 08 64 39 76

✉ jerome@infrico.com

Direction

Administrative

Sophia Choukri

☎ 06 58 04 33 15

✉ sophia@infrico.com

Service Compatibilité et Facturation

Valerie Simon:

☎ 07 61 98 47 50

☎ 02 43 42 00 33

✉ comptabilite@infrico.com

Service SAV

Stephane Vivet: Pièces détachées

☎ 02 53 49 17 23

✉ pieces@infrico.com

Miguel Burgos: SAV

☎ 02 53 49 17 22

✉ sav@infrico.com

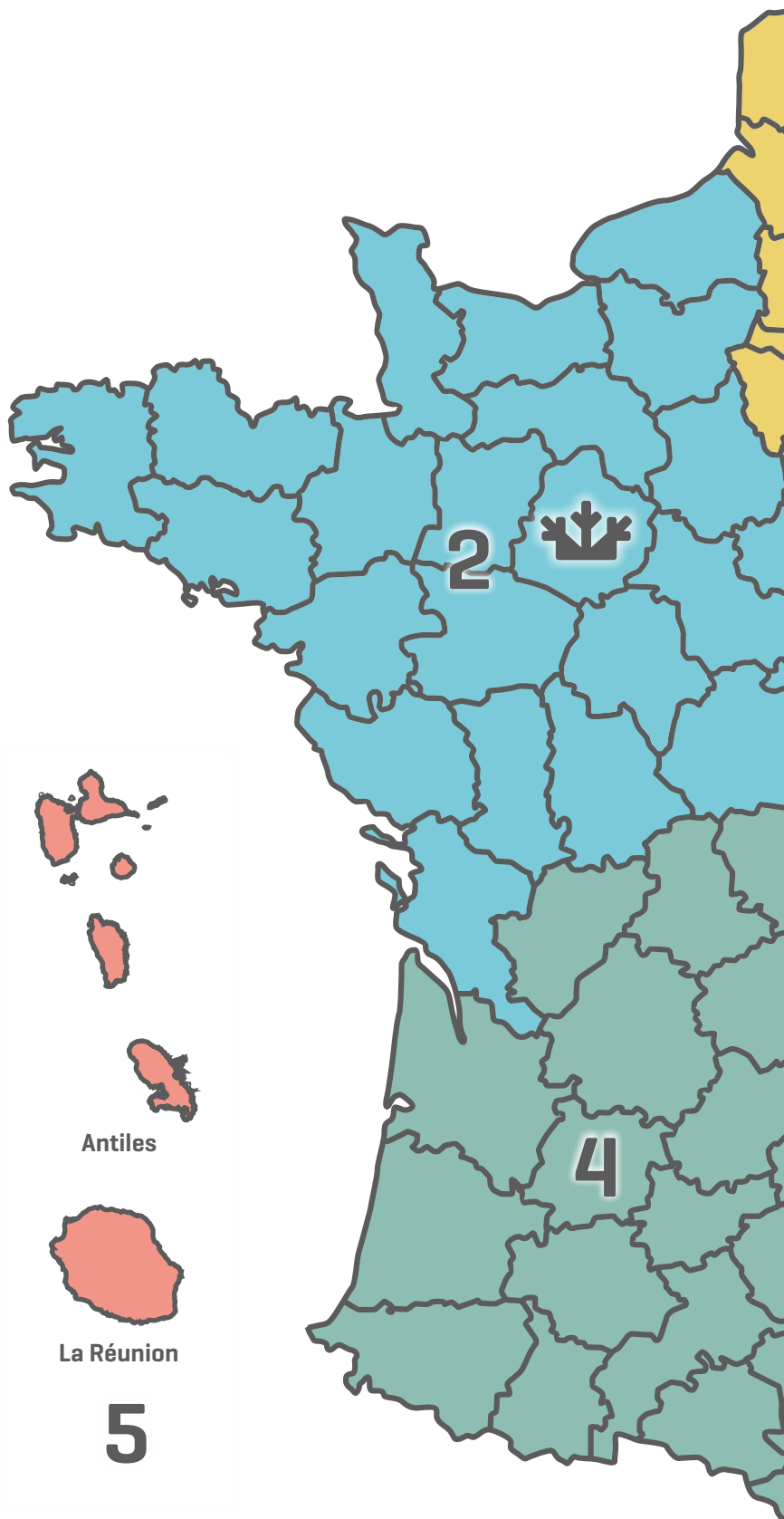

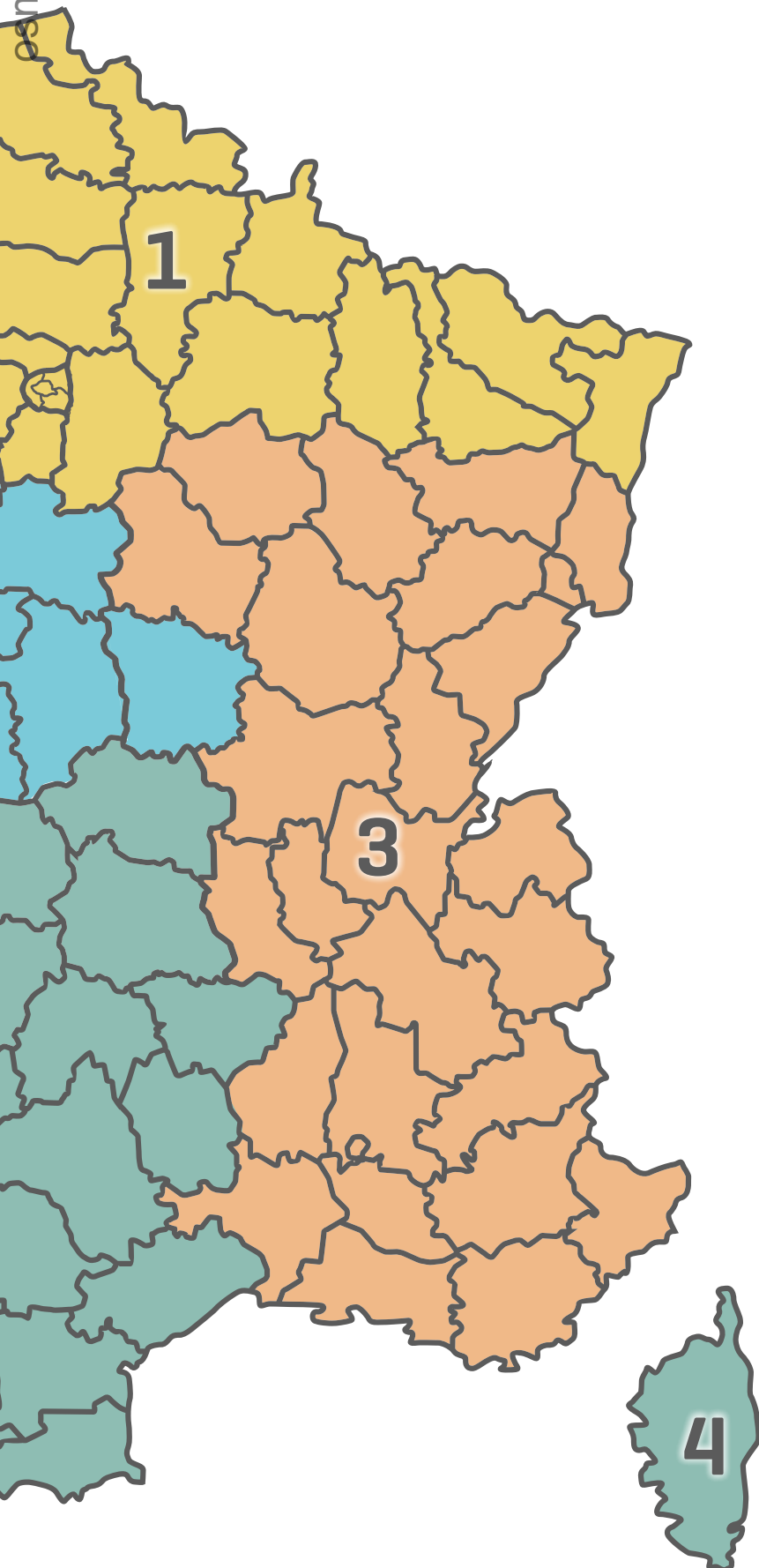

SECTEUR 1

Paris - Île de France
Nord - Est

Mickaël Diaz:
mickael@infrico.com
Tél: 06 07 23 00 97

SECTEUR 2

Nord-Ouest

Jerome Crespel:
jerome@infrico.com
Tél: 06 08 64 39 76

SECTEUR 3

Sud Est

Maxime Bernigaud
mbernigaud@infrico.com
Tél: 06 74 91 73 03

SECTEUR 4

Sud Ouest - Corse

Vincent Lecocq:
vincent@infrico.com
Tél: 07 72 77 49 65

OUTRE MER - 5

La Martinique, Guadeloupe, La
Réunion, Mayotte, La Guyane,
Nouvelle Calédonie

Claire Brossier
commercial@infrico.com
Tél: 06 44 17 72 17



14 Delegaciones
14 Delegations
14 Délégations



21 Delegaciones
21 Delegations
21 Délégations



Más de 700 trabajadores
More than 700 employees
Plus de 700 employés



Certificado Origen Español
Spanish Origin Certificate
Certificat d'Origine Espagnol



160.000 m² dedicados a la fabricación de equipos de refrigeración comercial de última generación

160.000 m² dedicated to the manufacture of commercial refrigeration equipment of last generation

160.000 m² dédiés à la fabrication de produits de réfrigération commerciale de pointe



osmarc.es



Colaboramos / We collaborate / En collaboration avec



AEFYT
ASOCIACIÓN DE EMPRESAS DE FRÍO
Y SUS TECNOLOGÍAS



asociación de fabricantes
españoles exportadores
de equipamientos para
hostelería y colectividades

AFAR
ASOCIACIÓN DE FABRICANTES
ANDALUCES DE REFRIGERACIÓN



MEMBER ASSOCIATION
EUROVENT
EUROPEAN INDUSTRY ASSOCIATION



FOODSERVICE CONSULTANTS SOCIETY INTERNATIONAL



North American Association of
Food Equipment Manufactures

Participamos en / We participate in / Nous sommes présents



Responsabilidad Social Corporativa [RSC]
Corporate Social Responsibility [CSR]
Responsabilité Sociale des Entreprises [RSC]



Asociación
española
contra el cáncer

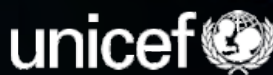

Patrocinador / Sponsor
Club Deportivo Lucena

Ferias y Exhibiciones / Fairs and Exhibitions / Salons et Expositions

Infrico está presente en las principales ferias internacionales del sector, donde año tras año presenta las novedades, diseños y avances tecnológicos de sus productos.

Infrico is present at the main international fairs of the sector, where year after year we present the novelties, designs and technological advances of our products.

Infrico est présent dans les principaux salons du secteur, durant lesquels années après années, sont présentées les nouveautés et dernières avancées techniques de ses produits.



+Info: www.infrico.com

osmarc.es



Novedades

New Products / Lancements



MINIMARKET
ERC50PH / BT



GN1/1 700
BMGN1470A

Clase energ.
Energy class
Classe Énerg.
A+
INVERTER



GN2/1
AGB701A



UC (American Line)
UC48PMT
UC27RCR



UC27P

MR (American Line)
MR67



MR41EN

MSG BT



NACIONAL 400/900L

AN401CR

AN902CR



BarStation



iLine



MPG (American Line)

MPG1490



AC MDA / EVV

AC140MDAB

EVV70



VISION

VCD10



COMBI

AS25U



+Info: www.infrico.com

JULIET
VJU18P



EXPERIENCE
VEX18UCP



BIGGIE
VPG37



ÁMBAR
VBR9PC / VBR PSS / VBR PDS



Waterin

Sistema Waterloop R290 de Infrico

hasta
-25%

Sistema eficiente, hasta el 25% de ahorro de energía.

Efficient system with up to 25% energy saving.

Système efficace avec jusqu'à 25 % d'économies d'énergie.

-75%

75% reducción carga refrigerante.

75% refrigerant charge reduction.

Réduction de 75 % de la charge de réfrigérant.

0€

Refrigerantes naturales SIN TASA.

Natural refrigerants WITHOUT CHARGE.

Réfrigérateurs naturels SANS TÂCHE.



Mínima carga refrigerante, aprox. 0.1kg/kw.

Minimum refrigerant load, aprox. 0.1kg/kw.

Charge minimale de réfrigérant, avec environ 0,1 Kg/kw de réfrigération.



Flexibilidad de implantación.
Flexibility of implementation.
Flexibilité de mise en oeuvre.



Recuperación de calor en la instalación.
Heat recovery in the installation.
Récupération de chaleur dans l'installation.



Condensadores sin mantenimiento.
Maintenance-free condensers.
Condensateurs de maintenance.



Posible eliminación de la sala de máquinas.
Possible elimination of the machine room.
Élimination possible, dans de nombreux cas, de la salle des machines.



Eliminación de riesgos típicos de inst. centralizadas.
Elimination of the typical risks of central. installations.
Élimination des risques typiques des installations centralisées.



Menor riesgo de fugas.
Reduced risk of leakage.
Moins de risques de fuites.

FHC ICE CUBE

FHIKU26AHC

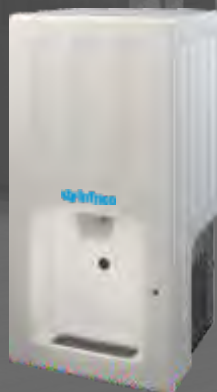

FHDSS42A/W



CONGELADOR/FREEZER/CONGÉLATEURS -70°C

UL100



VISION

EHCV2000VSC



400L

RV400SD



FS400GD



HT

HT2021



SALAMANDRA

ULTRA-RÁPIDA CONTACT /
ULTRARAPID CONTACT /
ULTRA-RAPIDE CONTACT



Enfriadores

Boottle Cooler / Refroidisseur de bouteilles





 Infrico

4.0



Serie / Series / Série

EFP



EFP EG
EFP II _____ 32-33

Serie / Series / Série

EBC



EB II _____ 34-35

Serie / Series / Série

ERV (850/920)



ERV SH
ERV II SH
ERV PP
ERV
ERV C _____ 36-39

Serie / Series / Série

ERV inox



ERV II
ERV PP II _____ 40-41

Serie / Series / Série

ERV / ERC



ERV
ERC
ERC B _____ 42-43

Serie / Series / Série

MINIMARKET

NEW



ERC PH
ERC PH BT _____ 44-45

Serie / Series / Série

NEC



NEC RV
NEC FS
NEC FV _____ 46-47

Serie / Series / Série

SUPERCOOLER



SPC
SPC B _____ 48-49

Serie / Series / Série

ESC / TA



ESC
ESC CR
TA II _____ 50-51



Digital control easy and intuitive—touch screen IP65 protection.

1. Enfriadores

Bottle coolers / Refroidisseurs de bouteilles

Iluminación / Lighting / Éclairage

Incorporación de iluminación LED, llegando a reducir el consumo energético entre un 80% y 90%, respecto a una bombilla tradicional. RGB opcional.

LED lighting incorporated, reducing energetic consumption between 80% and 90% respect to a traditional light bulb. RGB optional.

Éclairage LED, réduisant la consommation énergétique entre 80% et 90%, par rapport à une ampoule traditionnelle. RGB optionnel.



Cabezal iluminado opcional.

Option Canopy.

Canopy en option.



EFP EG



ERV

850
[Mod. SH]

920

Doble acristalamiento templado, bajo emisor con carga de Argón [4-27-4].

Double tempered glass, low-e with argon charge [4-27-4].

Triple vitrage et verre trempé [4-12-3-12-4].

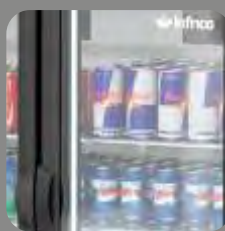

Nuevo Co
intuitivo I

New Digit
intuitive-

Nouveau
intuitif IP



Controlador digital táctil e IP 65.

Digital control easy and touch screen IP65 protection.

Contrôleur digital tactile e IP 65.









Nuevo Controlador digital táctil e intuitivo IP 65.

New Digital control easy and intuitive-touch screen IP65 protection.

Nouveau Contrôleur digital tactile e intuitif IP 65.



Refrigerador de botellas / Chest bottle cooler / Refroidisseur de bouteilles

| MODELO MODELE MODÈLE |  |  |  |  |  |  |
|--|---|---|---|--|---|---|
| | EFP 1000 EG | EFP 1500 EG | EFP 2000 EG | EFP 1000 II | EFP 1500 II | EFP 2000 II |
| Precio Price Prix | 719 € | 966 € | 1.146 € | 920 € | 1.298 € | 1.511 € |
| Medidas Measures [mm] Mesures | 1004 x 550 x 880 mm. | 1479 x 550 x 880 mm. | 1954 x 550 x 880 mm. | 1004 x 550 x 880 mm. | 1479 x 550 x 880 mm. | 1954 x 550 x 880 mm. |
| Temperatura Temperature Température | +3°C/+6°C | | | | | |
| Clase Climática Climatic class Classe climatique | 4 / 38°C | | | | | |
| Tensión/Frecuencia Electrical data Tension électrique | 230V/1ph/50Hz | | | | | |
| Controlador Controller Régulateur | Termostático / Thermostatic / Thermostatique | | | | | |
| Material Material [EXT/INT] Matériel | Exterior plastificado blanco / Encimera INOX AISI 304 Exterior prepainted / INOX AISI 304 worktop Extérieur plastifié blanc / Dessus INOX AISI 304 | | | Encimera INOX AISI 304 / Interior-Exterior AISI 430 INOX AISI 304 Worktop / AISI 430 Interior-Exterior Dessus INOX AISI 304 / Intérieur-Extérieur AISI 430 | | |
| Espesor Thickness Épaisseur | 40 | | | | | |
| Aislamiento Isolation Isolation | 40kg/m ³ / Free CFC's / Zero ODP-GWP | | | | | |
| Capacidad Capacity Capacité | 200 | 305 | 415 | 200 | 305 | 415 |
| Puertas Doors Portes | 2 | 3 | 4 | 2 | 3 | 4 |
| Nº separadores Nº dividers Nº séparateurs | 1 | 2 | 3 | 1 | 2 | 3 |
| Sistema de frío Cooling System Système de froid | Condensación Forzado / Forced air condensation / Condensation Ventilé Evaporador estático / Static evaporator / Évaporateur statique | | | | | |
| Desescarche Defrost Dégivrage | - | | | | | |
| Expansión Expansion Expansion | Capilar / Capillary / Capillaire | | | | | |
| Potencia Power Puissance | 122 | 180 | 180 | 122 | 180 | 180 |
| Potencia frig. Cooling capacity Puissance Frig. | 169 | 370 | 370 | 169 | 370 | 370 |
| Consumo Consumption Consommation | - | | | | | |
| Clase energética Energy class Classe Énerg. | - | | | | | |
| Refrigerante Refrigerant Gaz | R-600a | R-290 | | R-600a | R-290 | |
| Opcional Optional Options | Separador / Divider / Séparateur [504X26] 45 € 115V/1 ph/60 Hz Sin incremento / No increase / Sans supplément 230V/1 ph/60 Hz Sin incremento / No increase / Sans supplément | | | | | |

Serie / Series / Série **EFP**

+Info: www.infrico.com



EFP 2000 EG

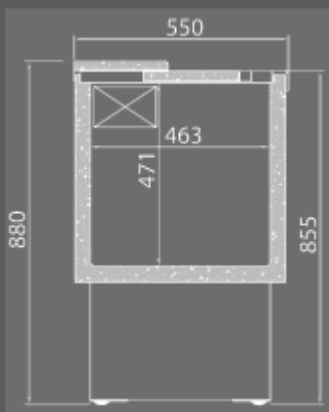







EFP 1000 II



EFP 1500 EG

Refrigerador de botellas / Chest bottle cooler / Refrigerateur de bouteilles (EB)

Refrigerador de botellas con cajones / Chest bottle cooler with drawers / Refrigerateur de bouteilles avec tiroirs (EBC)

| MODELO MODELE MODÈLE |  |  |  |  |  |  |  |
|--|---|---|---|---|---|---|---|
| | EB 1000 II | EB 1500 II | EB 2000 II | EB 2500 II | EBC 1000 II | EBC 1500 II | EBC 2000 II |
| Precio Price Prix | 1.112 € | 1.436 € | 1.681 € | 2.064 € | 1.457 € | 1.964 € | 2.486 € |
| Medidas Measures [mm] Mesures | 1004 x 550 x 865 mm. | 1479 x 550 x 865 mm. | 1954 x 550 x 865 mm. | 2429 x 550 x 865 mm. | 1004 x 550 x 865 mm. | 1479 x 550 x 865 mm. | 1954 x 550 x 865 mm. |
| Temperatura Temperature Température | +3°C/+6°C | | | | | | |
| Clase Climática Climatic class Classe climatique | 4 / 38°C | | | | | | |
| Tensión/Frecuencia Electrical data Tension électrique | 230V/1ph/50Hz | | | | | | |
| Controlador Controller Régulateur | - | | | | | | |
| Material Matériel [EXT/INT] | Encimera INOX AISI 304 / Interior-Exterior AISI 430 INOX AISI 304 Worktop / AISI 430 Interior-Exterior Dessus INOX AISI 304 / Interior-Extérieur AISI 430 | | | | | | |
| Espesor Thickness Épaisseur | 40 | | | | | | |
| Aislamiento Isolation Isolation | 40kg/m ³ / Free CFC's / Zero ODP-GWP | | | | | | |
| Capacidad Capacity Capacité | 265 | 445 | 620 | 800 | 265 | 445 | 620 |
| Puertas Doors Portes | 2 | 3 | 4 | 5 | 2 | 3 | 4 |
| Nº Separadores Nº Dividers Nº Séparateur | 1 | 2 | 3 | 4 | 1 | 2 | 3 |
| Sistema de frío Cooling System Système de froid | Forzado / Forced air / Ventilé Evaporador estático / Static evaporator / Évaporateur statique | | | | | | |
| Desescarche Defrost Dégivrage | - | | | | | | |
| Expansión Expansion Expansion | Capilar / Capillary / Capillaire | | | | | | |
| Potencia Power Puissance | 122 | 180 | 180 | 355 | 122 | 180 | 180 |
| Potencia frig. Cooling capacity Puissance Frig. | 169 | 370 | 370 | 690 | 169 | 343 | 343 |
| Consumo Consumption Consommation | - | | | | | | |
| Clase energética Energy class Classe Énerg. | - | | | | | | |
| Refrigerante Refrigerant Gaz | R-600a | R-290 | | | R-600a | R-290 | |
| Opcional Optional Options | Separador / Divider / Séparateur [504X32] 46 € | | | | | | |
| | 115V/1 ph/60 Hz Sin incremento / No increase / Sans supplément | | | | 230V/1 ph/60 Hz Sin incremento / No increase / Sans supplément | | |

Serie / Series / Série **EB / EBC**

+Info: www.infrico.com



EBC 2000 II

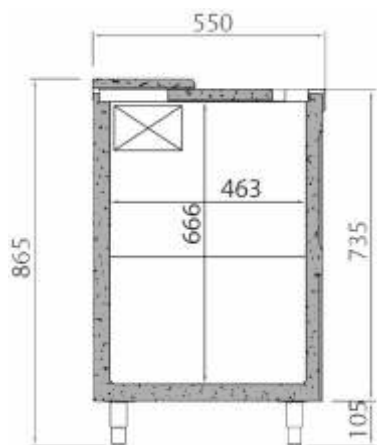







EB 1000 II



EBC 1000 II



Expositor refrigerado horizontal altura 850mm / Back-Bar 850mm height / Arrière bar horizontal hauteur 850mm

| MODELO MODELE MODÈLE |  |  |  |  |  |  |
|--|---|---|---|--|---|---|
| | ERV 15 SH | ERV 25 SH | ERV 35 SH | ERV 15 II SH | ERV 25 II SH | ERV 35 II SH |
| Precio Price Prix | 1.058 € | 1.370 € | 1.712 € | 1.170 € | 1.503 € | 1.879 € |
| Medidas Measures [mm] Mesures | 600 x 510 x 850 mm. | 900 x 510 x 850 mm. | 1350 x 510 x 850 mm. | 600 x 510 x 850 mm. | 900 x 510 x 850 mm. | 1350 x 510 x 850 mm. |
| Temperatura Temperature Température | +4°C/+12°C | | | | | |
| Clase Climática Climatic class Classe climatique | 4 / 38°C | | | | | |
| Tensión/Frecuencia Electrical data Tension électrique | 230V/1ph/50Hz | | | | | |
| Controlador Controller Régulateur | Digital / Digital / Électronique IP65 | | | | | |
| Material Material [EXT/INT] Matériel | Exterior acero plastificado negro / Interior acero plastificado gris Black plastic coated steel exterior / Grey plastic coated steel interior Extérieur acier plastifié noir / Intérieur acier plastifié gris | | | Interior plastificado gris / Exterior INOX AISI 430 Interior prepainted grey / INOX AISI 430 Exterior Intérieur plastifié gris / Extérieur INOX AISI 430 | | |
| Espesor Thickness Épaisseur | 30 | | | | | |
| Aislamiento Isolation Isolation | 40kg/m ³ / Free CFC's / Zero ODP-GWP | | | | | |
| Capacidad Capacity Capacité | 124 | 193 | 296 | 124 | 193 | 296 |
| Puertas Doors Portes | 1 | 2 | 3 | 1 | 2 | 3 |
| Nº parrillas J. guías Nº shelves / Slides Nº de grilles / Glissière | 2 | 2 | 2 | 2 | 2 | 2 |
| Sistema de frío Cooling System Système de froid | Forzado / Forced air / Ventilé | | | | | |
| Desescarche Defrost Dégivrage | Automático / Automatic / Automatique | | | | | |
| Expansión Expansion Expansion | Capilar / Capillary / Capillaire | | | | | |
| Potencia Power Puissance | 250 | 320 | 259 | 250 | 320 | 259 |
| Potencia fríg. Cooling capacity Puissance Frig. | 370 | | | | | |
| Consumo Consumption Consommation | - | | | | | |
| Clase energética Energy class Classe Énerg. | - | | | | | |
| Refrigerante Refrigerant Gaz | R-290 | | | | | |
| Opcional Optional Options | Iluminación Led RGB con cambio de color [por puerta] / Led lighting RGB change of colour [per door] / LED RGB avec changement de couleur [par porte] 67 € 115V/1 ph/60 Hz Sin incremento / No increase / Sans supplément 230V/1 ph/60 Hz Sin incremento / No increase / Sans supplément | | | | | |

Serie / Series / Série **ERV**

+Info: www.infrico.com

ERV 25 SH





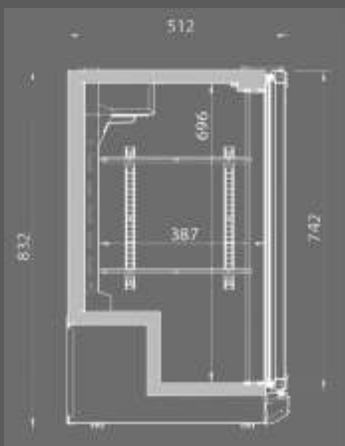



Controlador digital IP 65.
Digital control IP65
Contrôleur digital IP 65.



ERV 35 II SH

Expositor refrigerado horizontal altura 920mm / Back-Bar 920mm height / Arrière bar horizontal hauteur 920mm

Puertas correderas
Sliding doors
Portes coulissantes

| MODELO MODELE MODÈLE |  |  |  |  |  |  |  |
|---|--|---|---|---|---|---|---|
| | ERV 15 PP | ERV 25 PP | ERV 35 PP | ERV 15 | ERV 25 | ERV 35 | ERV 25 C |
| Precio Price Prix | 1.063 € | 1.369 € | 1.635 € | 1.068 € | 1.390 € | 1.717 € | 1.437 € |
| Medidas Measures [mm] Mesures | 600 x 510 x 920 mm. | 900 x 510 x 920 mm. | 1350 x 510 x 920 mm. | 600 x 510 x 920 mm. | 900 x 510 x 920 mm. | 1350 x 510 x 920 mm. | 900 x 510 x 920 mm. |
| Temperatura Temperature Température | +4°C/+8°C | | | +4°C/+12°C | | | |
| Clase Climática Climatic class Classe climatique | 4 / 38°C | | | | | | |
| Tensión/Frecuencia Electrical data Tension électrique | 230V/1ph/50Hz | | | | | | |
| Controlador Controller Régulateur | Digital / Digital / Électronique IP65 | | | | | | |
| Material Material [EXT/INT] Matériel | Exterior acero plastificado negro / Interior acero plastificado gris Black plastic coated steel exterior / Grey plastic coated steel interior Extérieur acier plastifié noir / Intérieur acier plastifié gris | | | | | | |
| Espesor Thickness Épaisseur | 30 | | | | | | |
| Aislamiento Isolation Isolation | 40kg/m ³ / Free CFC's / Zero ODP-GWP | | | | | | |
| Capacidad Capacity Capacité | 140 | 220 | 330 | 140 | 220 | 330 | 220 |
| Puertas Doors Portes | 1 | 2 | 3 | 1 | 2 | 3 | 2 |
| Nº parrillas / Guías Nº shelves / Slides Nº de grilles / Glissière | 2 | | | | | | |
| Sistema de frío Cooling System Système de froid | Forzado / Forced air / Ventilé | | | | | | |
| Desescarche Defrost Dégivrage | Automático / Automatic / Automatique | | | | | | |
| Expansión Expansion Expansion | Capilar / Capillary / Capillaire | | | | | | |
| Potencia Power Puissance | 250 | 320 | 325 | 250 | 320 | 325 | 320 |
| Potencia frig. Cooling capacity Puissance Frig. | 370 | | | | | | |
| Consumo Consumption Consommation | - | | | | | | |
| Clase energética Energy class Classe Énerg. | - | | | | | | |
| Refrigerante Refrigerant Gaz | R-290 | | | | | | |
| Opcional Optional Options | <p>Iluminación Led RGB con cambio de color (por puerta) / Led lighting RGB change of colour (per door) / LED RGB avec changement de couleur (par porte) 67 €</p> <p>Parrilla / Wire shelf / Grille ERV15 (502X27) 25 €</p> <p>Parrilla / Wire shelf / Grille ERV25 (502X28) 33 €</p> <p>Parrilla / Wire shelf / Grille ERV35 (502X31) 57 €</p> <p>115V/1 ph/60 Hz Sin incremento / No increase / Sans supplément</p> <p>230V/1 ph/60 Hz Sin incremento / No increase / Sans supplément</p> | | | | | | |

Serie / Series / Série **ERV**

+Info: www.infrico.com

ERV 25 PP



Video del producto
Product Video
Vidéo du produit



Infrico Youtube



ERV 15





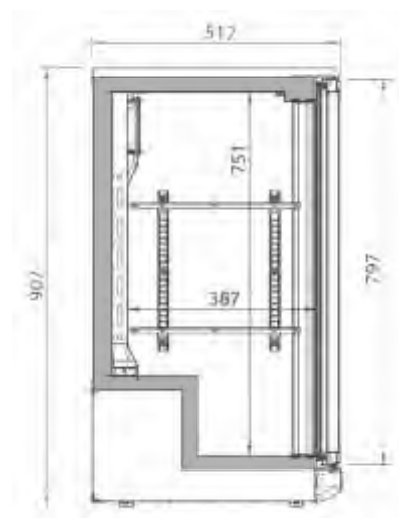



ERV 25



Expositor refrigerado horizontal altura 920mm / Back-Bar 920mm height / Arrière bar horizontal hauteur 920mm

REFRIGERACIÓN / REFRIGERATOR / POSITIF / 920mm †

| MODELO MODELE MODÈLE |  |  |  |  |  |  |
|---|--|---|---|---|---|---|
| | ERV 15 II | ERV 25 II | ERV 35 II | ERV 15 PP II | ERV 25 PP II | ERV 35 PP II |
| Precio Price Prix | 1.226 € | 1.598 € | 1.958 € | 1.221 € | 1.577 € | 1.877 € |
| Medidas Measures [mm] Mesures | 600 x 510 x 920 mm. | 900 x 510 x 920 mm. | 1350 x 510 x 920 mm. | 600 x 510 x 920 mm. | 900 x 510 x 920 mm. | 1350 x 510 x 920 mm. |
| Temperatura Temperature Température | +4°C/+12°C | | | | | |
| Clase Climática Climatic class Classe climatique | 4 / 38°C | | | | | |
| Tensión/Frecuencia Electrical data Tension électrique | 230V/1ph/50Hz | | | | | |
| Controlador Controller Régulateur | Digital / Digital / Électronique IP65 | | | | | |
| Material Material [EXT/INT] Matériau | Interior plastificado gris / Exterior INOX AISI 430 Interior prepainted / INOX AISI 430 Exterior Intérieur plastifié gris / Extérieur INOX AISI 430 | | | | | |
| Espesor Thickness Épaisseur | 30 | | | | | |
| Aislamiento Isolation Isolation | 40kg/m ³ / Free CFC's / Zero ODP-GWP | | | | | |
| Capacidad Capacity Capacité | 140 | 220 | 330 | 140 | 220 | 330 |
| Puertas Doors Portes | 1 | 2 | 3 | 1 | 2 | 3 |
| Nº parrillas / Guías Nº shelves / Slides Nº de grilles / Glissière | 2 | | | | | |
| Sistema de frío Cooling System Système de froid | Forzado / Forced air / Ventilé | | | | | |
| Desescarche Defrost Dégivrage | Automático / Automatic / Automatique | | | | | |
| Expansión Expansion Expansion | Capilar / Capillary / Capillaire | | | | | |
| Potencia Power Puissance | 250 | 320 | 325 | 250 | 320 | 325 |
| Potencia frig. Cooling capacity Puissance Frig. | 370 | | | | | |
| Consumo Consumption Consommation | - | | | | | |
| Clase energética Energy class Classe Énerg. | - | | | | | |
| Refrigerante Refrigerant Gaz | R-290 | | | | | |
| Opcional Optional Options | <p>Iluminación Led RGB con cambio de color [por puerta] / Led lighting RGB change of colour [per door] / LED RGB avec changement de couleur [par porte] 67 €</p> <p>Parrilla / Wire shelf / Grille ERV15 (502X27) 25 €</p> <p>Parrilla / Wire shelf / Grille ERV25 (502X28) 33 €</p> <p>Parrilla / Wire shelf / Grille ERV35 (502X31) 57 €</p> <p>115V/1 ph/60 Hz Sin incremento / No increase / Sans supplément</p> <p>230V/1 ph/60 Hz Sin incremento / No increase / Sans supplément</p> | | | | | |

Serie / Series / Série **ERV INOX / ERV PP**

+Info: www.infrico.com

ERV 25 PP II



Controlador digital IP 65.
Digital control IP65
Contrôleur digital IP 65.



ERV 35 II

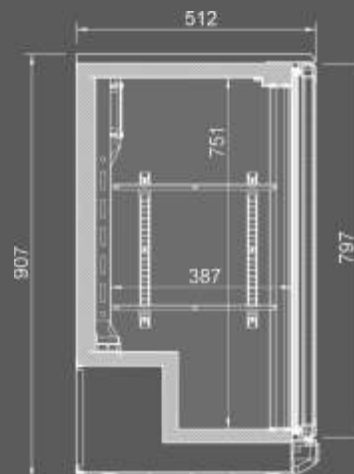

Expositor refrigerado vertical / Glass door merchandiser / Armoire d'exposition réfrig. verticale

Expositor refrigerado vertical / Glass door merchandiser / Armoire d'exposition réfrig. verticale

REFRIGERACIÓN / REFRIGERATOR / POSITIF

| MODELO MODELE MODÈLE | ERV 53 | ERV 83 | ERC 36 B | ERC 100 | ERC 130 | ERC 200 |
|---|---|----------------------------|---|-----------------------------|-----------------------------|---|
| Precio Price Prix | 1.757 € | 2.267 € | 1.626 € | 3.059 € | 3.229 € | 4.563 € |
| Medidas Measures [mm] Mesures | 600 x 510 x 1820 mm. | 900 x 510 x 1820 mm. | 620 x 595 x 1870 mm. | 1385 x 704 x 2005 mm. | 1385 x 804 x 2005 mm. | 2081 x 804 x 2005 mm. |
| Temperatura Temperature Température | +4°C/+12°C | | +4°C/+8°C | | | |
| Clase Climática Climatic class Classe climatique | 4 / 38°C | | | | | |
| Tensión/Frecuencia Electrical data Tension électrique | 230V/1ph/50Hz | | | | | |
| Controlador Controller Régulateur | Digital / Digital / Électronique IP65 | | | | | |
| Material Material [EXT/INT] Matériel | Ext. acero plastif. negro / Int. acero plastificado gris Black plastic coated steel ext. / Grey plastic coated steel int. Ext. acier plastifié noir / Int. acier plastifié gris | | Ext/Int acero plastificado blanco White plastic coated steel exterior/interior Extérieur/Intérieur acier plastifié blanc | | | |
| Espesor Thickness Épaisseur | 30 | | 50 | | | |
| Aislamiento Isolation Isolation | 40kg/m ³ / Free CFC's / Zero ODP-GWP | | | | | |
| Capacidad Capacity Capacité | 280 | 435 | 355 | 1110 | 1310 | 2030 |
| Puertas Doors Portes | 1 | 2 | 1 | 2 | | 3 |
| N° parrillas / Guías N° shelves / Slides N° de grilles / Glissière | 5 | | 4 | | | |
| Sistema de frío Cooling System Système de froid | Ventilado / Forced air / Ventilé | | | | | |
| Desescarche Defrost Dégivrage | Parada de compresor / Compressor off / Arrêt du compresseur | | | | | |
| Expansión Expansion Expansion | Capilar / Capillary / Capillaire | | | | | Válvula termostática / Expansion valve / Détendeur thermostatique |
| Potencia Power Puissance | 190 | 443 | 400 | 795 | 787 | 1111 |
| Potencia frig. Cooling capacity Puissance Frig. | 370 | 690 | 370 | 950 | 1296 | 1440 |
| Consumo Consumption Consommation | 1,67 | 3,39 | - | 5,8 | 6,8 | 9,2 |
| Clase energética Energy class Classe Énerg. | A | B | - | B | C | |
| Refrigerante Refrigerant Gaz | R-290 | | | | | |
| Opcional Optional Options | Iluminación Led RGB con cambio de color [por puerta] / Led lighting RGB change of colour [per door] / LED RGB avec changement de couleur [par porte] 67 € | | Iluminación Led RGB con cambio de color [por puerta] / Led lighting RGB change of colour [per door] / LED RGB avec changement de couleur [par porte] 67 € | | | |
| | Parrilla / Wire shelf / Grille ERV53 (502X27) 25 € | | 115V/1 ph/60 Hz Sin incremento / No increase / Sans supplément | | | |
| | Parrilla / Wire shelf / Grille ERV83 (502X28) 33 € | | 230V/1 ph/60 Hz Sin incremento / No increase / Sans supplément | | | |
| | Cabezal iluminado / Illuminated canopy / Bandeau lumineux Consultar | | - Sin incremento / No increase / Sans supplément | | | |
| | | | Interior - Exterior / Interior - Exterior / Intérieur - extérieur Negro / Black / Noir RAL 9017 Sin incremento / No increase / Sans supplément | | | |

Serie / Series / Série **ERV**
 Serie / Series / Série **ERC**

+Info: www.infrico.com

Cabezal iluminado
 Canopy illuminated
 Bandeau lumineux



ERC 200

ERC 130 / 200



ERC 100

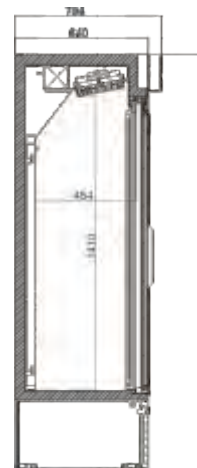

ERV 83

Video del producto
 Product Video
 Vidéo du produit



Infrico Youtube

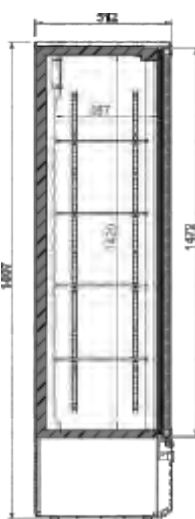

ERC 36 B

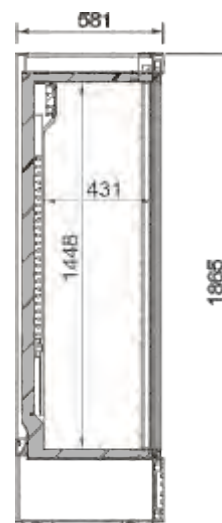

Expositor refrigerado vertical / Glass door merchandiser / Armoire d'exposition réfrig. verticale

NEW



NEW



MODELO
MODELE
MODÈLE

ERC 50 PH



ERC 50 PH BT

ERC 130 PH

ERC 130 PH BT

ERC 200 PH

ERC 200 PH BT

| | | | | | | |
|---|--|--|---|---|---|--|
| Precio Price Prix | 2.570 € | 3.560 € | 4.043 € | 5.447 € | 5.045 € | 6.905 € |
| Medidas Measures [mm] Mesures | 687 x 842 x 2003 mm. | | 1384 x 842 x 2003 mm. | | 2081 x 842 x 2003 mm. | |
| Temperatura Temperature Température | +4°C/+8°C | -18°C | +4°C/+8°C | -18°C | +4°C/+8°C | -18°C |
| Clase Climática Climatic class Classe climatique | 4 / 38°C | | | | | |
| Tensión/Frecuencia Electrical data Tension électrique | 230V/1ph/50Hz | | | | | |
| Controlador Controller Régulateur | Digital / Digital / Électronique IP65 | | | | | |
| Material Material [EXT/INT] Matériel | Int acero plastificado blanco / Ext acero plastificado negro White plastic coated steel interior / Black plastic coated steel exterior Intérieur acier plastifié blanc / Extérieur acier plastifié noir | | | | | |
| Espesor Thickness Épaisseur | 55 | | | | | |
| Aislamiento Isolation Isolation | 40kg/m ³ / Free CFC's / Zero ODP-GWP | | | | | |
| Capacidad Capacity Capacité | 500 | | 1310 | | 2030 | |
| Puertas Doors Portes | 1 | | 2 | | 3 | |
| Nº estantes Nº shelves Nº d'étagères | 4 | | 4 | | 8 | |
| Sistema de frío Cooling System Système de froid | Ventilado / Forced air / Ventilé | | | | | |
| Desescarche Defrost Dégivrage | Parada compresor / Compresor off / Arrêt compresseur. | Gas caliente / Hot gas / Gaz chaud | Parada compresor / Compresor off / Arrêt compresseur. | Gas caliente / Hot gas / Gaz chaud | Parada compresor / Compresor off / Arrêt compresseur. | Gas caliente / Hot gas / Gaz chaud |
| Expansión Expansion Expansion | Capilar / Capillary / Capillaire | | | Válvula termostática / Expansion valve / Détendeur thermostatique | | |
| Potencia Power Puissance | 414 | 662 | 844 | 890 | 1123 | 1960 |
| Potencia frig. Cooling capacity Puissance Frig. | 690 | 583 | 1296 | | 1559 | 1484 |
| Consumo Consumption Consommation | 4,22 | 8,23 | 6,8 | 16,6 | 9,2 | 28 |
| Clase energética Energy class Classe Énerg. | C | C | C | D | C | D |
| Refrigerante Refrigerant Gaz | R-290 | | | | | |
| Opcional Optional Options | <p>Iluminación Led RGB con cambio de color (por puerta) / Led lighting RGB change of colour (per door) / LED RGB avec changement de couleur (par porte) 67 €</p> <p>Kit Portaprecios ERC 100/130 (KPPER13) 90 €</p> <p>Kit Portaprecios ERC200 (KPPER20) 140 €</p> <p>115V/1 ph/60 Hz BT: +3 % / Refrig. Sin incremento / Refrig. No increase / Refroid. Sans supplément</p> <p>230V/1 ph/60 Hz Sin incremento / No increase / Sans supplément</p> <p>Interior - Exterior / Interior - Exterior / Intérieur - extérieur Sin incremento / No increase / Sans supplément</p> <p> Total Negro / Black / Noir RAL 9017  Total Blanco / White / Blanc RAL 9016</p> | | | | | |

Serie / Series / Série **MINIMARKET**

+Info: www.infrico.com



ERC200PH



Controlador digital IP 65.
Digital control IP65
Contrôleur digital IP 65.

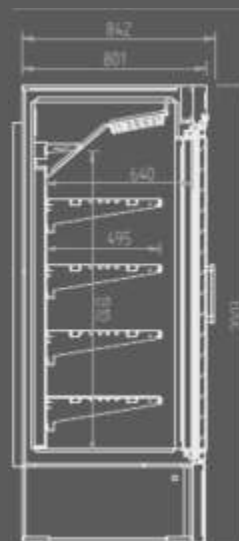

Video del producto

Product Video

Vidéo du produit



Infrico Youtube

NEW



ERC50PH



ERC130PH



ERC200PH BT

Expositor de refrigeración y congelación / Glass door merchandiser refrigerator and freezer / Armoire d'exposition réfrigération et congélation

REFRIGERACIÓN / REFRIGERATOR / POSITIVE

CONGELACIÓN / FREEZER / NÉGATIVE

| MODELO MODELE MODÈLE | NEC501RV | NEC1002RV | NEC401FS | NEC501FV | NEC1002FV |
|--|--|-----------------------|---|----------------------|--|
| Precio Price Prix | 2.405 € | 3.917 € | 2.426 € | 3.393 € | 5.305 € |
| Medidas Measures [mm] Mesures | 687 x 705 x 2010 mm. | 1385 x 705 x 2010 mm. | 687 x 670 x 2010 mm. | 687 x 705 x 2010 mm. | 1385 x 705 x 2010 mm. |
| Temperatura Temperature Température | +2°C/+8°C | | -15°C/-25°C | | |
| Clase Climática Climatic class Classe climatique | 4 / 38°C | | | | |
| Tensión/Frecuencia Electrical data Tension électrique | 230V/1ph/50Hz | | | | |
| Controlador Controller Régulateur | Digital / Digital / Électronique IP65 | | | | |
| Material Material [EXT/INT] Matériel | Ext/Int acero plastificado blanco / White plastic coated steel exterior/interior / Extérieur/Intérieur acier plastifié blanc | | | | |
| Espesor Thickness Épaisseur | 50 | | | | |
| Aislamiento Isolation Isolation | 40kg/m ³ / Free CFC's / Zero ODP-GWP | | | | |
| Capacidad Capacity Capacité | 500 | 1000 | 430 | 500 | 1000 |
| Puertas Doors Portes | 1 | 2 | 1 | | 2 |
| N° parrillas / Guías N° shelves / Slides N° de grilles / Glissière | 5 (530x460) | 10 (530x510) | 5 (438x556) | 5 (530x460) | 10 (530x510) |
| Sistema de frío Cooling System Système de froid | Forzado / Forced air / Ventilé | | Estático / Static / Statique | | Forzado / Forced air / Ventilé |
| Desescarche Defrost Dégivrage | Parada de compresor / Compressor off / Arrêt du compresseur | | Manual | | Gas caliente / Hot gas defrost / Gaz chaud |
| Expansión Expansion Expansion | Capilar / Capillary / Capillaire | | | | Termostática / Thermostatic / Thermostatique |
| Potencia Power Puissance | 414 | 445 | 487 | 662 | 826 |
| Potencia frig. Cooling capacity Puissance Frig. | 690 | | 445 | 583 | 723 |
| Consumo Consumption Consommation | 4,22 | 5,05 | - | 8,23 | 16,61 |
| Clase energética Energy class Classe Énerg. | C | B | - | C | D |
| Refrigerante Refrigerant Gaz | R-290 | | | | |
| Opcional Optional Options | Iluminación Led RGB con cambio de color (por puerta) / Led lighting RGB change of colour (per door) / LED RGB avec changement de couleur (par porte) | | | | 67 € |
| | 115V/1 ph/60 Hz 230V/1 ph/60 Hz Sin incremento / No increase / Sans supplément | | 115V/1 ph/60 Hz +3 230V/1 ph/60 Hz Sin incremento / No increase / Sans supplément | | |
| | Exterior (Solo Puerta, Cuadro y Rejilla) / Exterior (door, control panel and grille) / extérieur (porte, bandeau et grille) | | | | |
| |  Negro / Black / Noir RAL 9017 Sin incremento / No increase / sans supplément | | | | |

Serie / Series / Série **NEC**

+Info: www.infrico.com

NEC1002FV



Controlador digital IP 65.
Digital control IP65
Contrôleur digital IP 65.



Cabecal iluminado
Canopy illuminated
Bandeau lumineux

Triple acristalamiento templado, bajo emisivo con carga de Argón (4-12-3-12-4)
Triple tempered glass, low emission with Argon charge (4-12-3-12-4)
Triple vitrage trempé à faible émissivité avec Argon (4-12-3-12-4)

NEC501FV

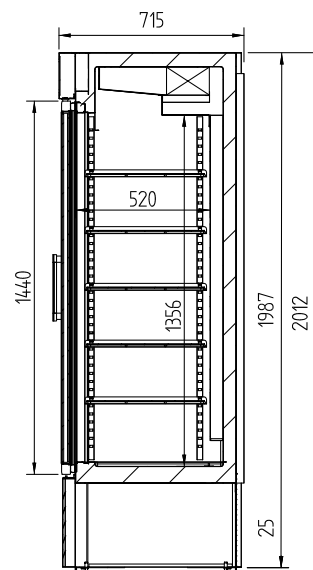

Enfriador de botellas Supercooler / Chest bottle cooler Supercooler / Réfrigérateur de bouteilles Supercooler



SPC501



SPC501B

| MODELO MODELE MODÈLE | SPC501 | SPC501B |
|--|---|--|
| Precio Price Prix | 3.650 € | 3.450 € |
| Medidas Measures [mm] Mesures | 687 x 728 x 2003 mm. | 687 x 728 x 2003 mm. |
| Temperatura Temperature [°C] Température | +0°C/-8°C | |
| Clase Climática Climatic class [°C] Classe climatique | 4 / 38°C | |
| Tensión/Frecuencia Electrical data Tension électrique | 230V/1ph/50Hz | |
| Controlador Controller Régulateur | Digital / Digital / Électronique IP65 | |
| Material Material [EXT/INT] Matériel | Int: acero Inox AISI 430 / Ext: acero Inox AISI 304 Int: Stainless Steel AISI 430 / Ext: Stainless Steel AISI 304 Int: Stainless Steel AISI 430 / Ext: Acier Inox AISI 304 | Int: acero Inox AISI 430 / Ext: Acero lacado negro Int: Stainless Steel AISI 430 / Ext: Black lacquered steel Int: Acier Inox AISI 430 / Ext: Acier laqué noir |
| Espesor Thickness [mm] Épaisseur | 50 | |
| Aislamiento Isolation [mm] Isolation | 40kg/m ³ / Free CFC's / Zero ODP-GWP | |
| Capacidad Capacity [L] Capacité | 500 | |
| Puertas Doors Portes | 1 | |
| Nº Estantes Shelving Nº d' étagères | 5 (560x480) | |
| Sistema de frío Cooling System Système de froid | Forzado / Forced air / Ventilé | |
| Desescarche Defrost Dégivrage | Gas caliente / Hot gas / Gaz chaud | |
| Expansión Expansion Expansion | Capilar / Capillary / Capillaire | |
| Potencia Power [W] Puissance | 757 | |
| Potencia frig. Cooling capacity [WA -10/-30°C] Puissance Frig. | 650 | |
| Consumo Consumption [kWh/ 24h] Consommation | - | |
| Clase energética Energy class Classe Énerg. | - | |
| Refrigerante Refrigerant Gaz | R-290 | |
| Opcional Optional Options | Parrilla / Wire shelf / Grille métallique (502x119) 92 € 115V/1 ph/60 Hz Sin incremento / No increase / Sans supplément 230V/1 ph/60 Hz Sin incremento / No increase / Sans supplément | |

Serie / Series / Série **SPC**

+Info: www.infrico.com



SPC501



Bebida en estado líquido sin congelar.



Temperatura bajo cero en menos de 2h.



Tecnología aplicable a todo tipo de bebidas



SPC501B



SPC501

Triple acristalamiento templado, bajo emisor con carga de Argón (4-12-3-12-4)
 Triple tempered glass, low emission with Argon charge (4-12-3-12-4)
 Triple vitrage trempé à faible émissivité avec Argon (4-12-3-12-4)

| Grado de alcohol Alcoholic strength Teneur en alcool | Punto de corte Set point Point de coupure |
|--|---|
| 5% < 5,5% | -7° |
| 4% < 5% | -6° |
| 3,5% < 4% | -5° |
| Cerveza/Beer/Bière 0,0% | -2° |
| Refrescos carbonatados/ Carbonated beverages Boissons gazeuses (non alcoolisées) | -2° |

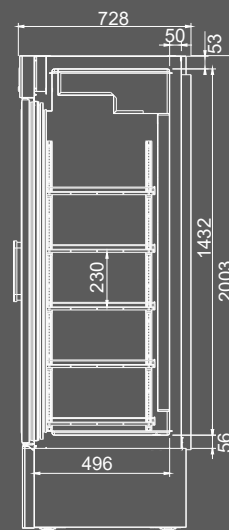





Escarchador de copas / Glass froster counter / Mini congélateur verticale

Tanque enfriador de agua / Water tank cooler / Refrigidisseurs d'eau

CONGELACIÓN / FREEZER / NÉGATIF

REFRIGERACIÓN / REFRIGERATOR / POSITIF

| MODELO MODELE MODÈLE |  |  |  |  |
|---|---|---|--|---|
| | ESC 50 | ESC 50 CR | TA 100 II | TA 180 II |
| Precio Price Prix | 1.433 € | 1.566 € | 2.283 € | 2.451 € |
| Medidas Measures [mm] Mesures | 570 x 600 x 850 mm. | 570 x 600 x 850 mm. | 1312 x 562 x 570 mm. | 902 x 562 x 1133 mm. |
| Temperatura Temperature Température | -5°C/-18°C | -5°C/-10°C | +1°C/+4°C | |
| Clase Climática Climatic class Classe climatique | 4 / 38°C | | | |
| Tensión/Frecuencia Electrical data Tension électrique | 230V/1ph/50Hz | | | |
| Controlador Controller Régulateur | Digital / Digital / Électronique IP65 | | | |
| Material Material [EXT/INT] Matériel | AISI 304 | | | |
| Espesor Thickness Épaisseur | 60 | | | |
| Aislamiento Isolation Isolation | 40kg/m ³ / Free CFC's / Zero ODP-GWP | | | |
| Capacidad Capacity Capacité | 95 | 95 | 100 | 180 |
| Puertas Doors Portes | 1 | 1 | - | |
| Nº parrillas / Guías Nº shelves / Slides Nº de grilles / Glissière | 2 (400 x 430) | 2 (400 x 430) | - | |
| Sistema de frío Cooling System Système de froid | Condensación Forzada / Forced air condensation / Condensation Ventilé Évaporador estático / Static evaporator / Évaporateur statique | | Forzado / Forced air / Ventilé | |
| Desescarche Defrost Dégivrage | - | | | |
| Expansión Expansion Expansion | Capilar / Capillary / Capillaire | | | |
| Potencia Power Puissance | 315 | 323 | 555 | 647 |
| Potencia frig. Cooling capacity Puissance Frig. | 306 | 306 | 1041 | 1296 |
| Consumo Consumption Consommation | - | | | |
| Clase energética Energy class Classe Énerg. | - | | | |
| Refrigerante Refrigerant Gaz | R-290 | | | |
| Opcional Optional Options | Juego de guías / Slides / Jeu de Glissières (503X11) 35 € Parrilla / Wire shelf / Grille (502X45) 42 € | | Soporte enfriador / Wall hangers / Support (STA) 179 € KIT Filtro agua / Water filter / Filtre à eau (4600x0018) 168 € | |
| | 115V/1 ph/60 Hz 3% 230V/1 ph/60 Hz Sin incremento / No increase / Sans supplément | | 115V/1 ph/60 Hz Sin incremento / No increase / Sans supplément 230V/1 ph/60 Hz Sin incremento / No increase / Sans supplément | |

Serie / Series / Série **ESC / TA**

+Info: www.infrico.com

ESC 50



ESC 50 CR

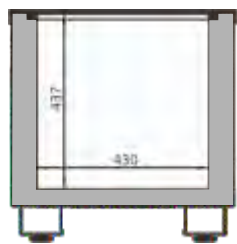

Opción Kit filtro de agua
Option Kit water filter
Optionel Kit filtre à eau



Serpentín interior en Acero Inoxidable
Stainless Steel interior coil
Serpentin intérieur en Acier Inoxydable

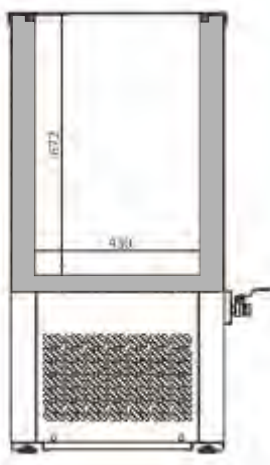

TA 100 II



TA 180 II

PHOTOBOOK





Mesas

Tables / Tables





Serie / Series / Série

600

BMPP II
 BMPP BT
 BMPP CR
 BMPP F II
 BMPP GR
 BMPP GR BT
 BMPP EN _____ 60-65

NEW

Serie / Series / Série

MSG/MPG

MSG
 MSG BT _____ 66-67

NEW

Serie / Series / Série

700GN1/1

BMGN A+
 BMGN II
 BMGN BT
 BMGN CR
 BMGN F II
 BMGN GR
 BMGN GR BT
 BMGN EN
 BMGN PDC _____ 68-77

Serie / Series / Série

ME

MPG
 ME VIP
 ME BAN
 ME EN
 ME II
 ME PIZZA
 ME KB _____ 76-81

NEW

Serie / Series / Série

BAR STATION

BST _____ 82-83

Serie / Series / Série

800MR

MR
 MR BT
 MR CR
 MR GR
 MR PDC
 MR PD CR
 MR EN
 MR H _____ 84-91

Serie / Series / Série

800MPL/MP

MPL
 MP
 MP CN _____ 92-93

Serie / Series / Série

FMPP

FMPP II
 FMPP CR
 FMPP GR _____ 94-95

Serie / Series / Série

MCAF/ME/MT

MCAF
 MCAF CD
 MCAF CI
 ME 30
 ME 60
 MT 60
 MT 70 _____ 96-97



2. Mesas Undercounters / Tables

Nuevo controlador digital táctil e intuitivo IP 65.

New digital control easy and intuitive-touch screen IP65 protection.

Nouveau contrôleur digital tactile e intuitif IP 65.



Encimera reforzada con Omegas de serie [series 600/700].

Reinforced worktop with Omegas as standard [600/700 series].

Plan de travail renforcé avec Omegas en standard [séries 600/700].



Doble acristalamiento templado, bajo emisoro con carga de Argón [4-27-4].

Double tempered glass, low-e with argon charge [4-27-4].

Double vitrage et verre trempé [4-12-3-12-4].



Encimera con fregadero opcional [BMPP F - BMGN F]

Worktop with optional sink [BMPP F - BMGN F]

Plan de travail avec évier optionnel [BMPP F - BMGN F]



Opcional: Manejo del control digital por WiFi o Bluetooth®

Optional: Operating digital control by WiFi or Bluetooth®

Optionnel: Fonctionnement de la commande numérique par WiFi ou Bluetooth®

Iluminación / Lighting / Éclairage

Incorporación de iluminación LED, llegando a reducir el consumo energético entre un 80% y 90%, respecto a una bombilla tradicional. RGB opcional.

LED lighting incorporated, reducing energetic consumption between 80% and 90% respect to a traditional light bulb. RGB optional.

Éclairage LED, réduisant la consommation énergétique entre 80% et 90%, par rapport à une ampoule traditionnelle. RGB optionnel.





Puertas con tirador de doble agarre y burlete plano desmontable "cleanless".

Double handle doors and flat gasket easily removable "cleanless".

Portes avec double poignée et joint plat facilement démontable "cleanless".

Kit cajones / Drawers kit / Kit tiroirs

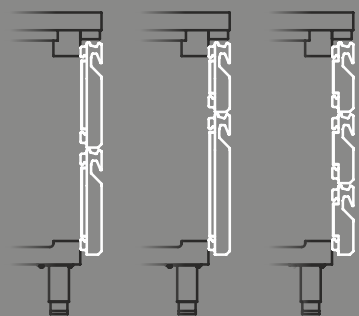

Nuevas guías Fulterer para cajones.

New Fulterer draw slides.

Nouveau glissières Fulterer pour tiroirs.

 70kg
 -25°C

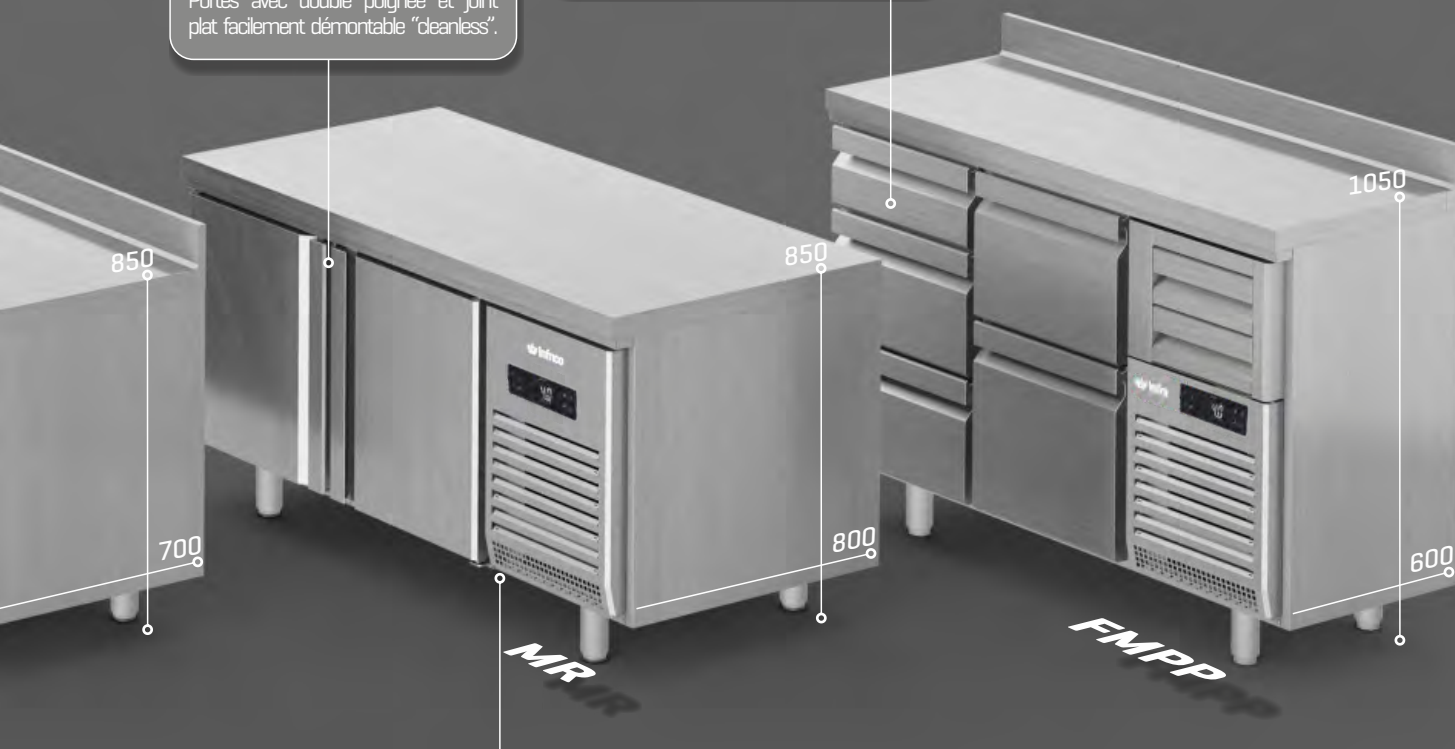

Refrigeración / Refrigeration / Réfrigération

Sistemas de frío ventilado. Bandejas evaporativas sin resistencia eléctrica para una mayor eficiencia energética. Sistemas de evaporación forzada. Evaporadores tratados con Epoxi de poliéster anticorrosión. Unidades sobredimensionadas y eficientes. Válvulas de expansión termostáticas y desescarches por gas caliente en baja temperatura. Marcos de puerta calefactados para evitar acumulación de hielo.

Forced air cooling systems. Energy-saving non-electric condensate pans. Forced evaporation systems. Evaporators treated with anti-corrosion polyester Epoxy. Oversized and efficient units. Expansion valves. Hot gas defrost. Heating door frames to prevent ice build-up.

Systèmes de froid ventilé. Bacs d'évaporation sans résistances électriques pour une meilleure efficacité énergétique. Systèmes d'évaporation forcé. Évaporateurs traités avec un epoxy polyester anticorrosion. Unités efficaces et surdimensionnées. Valves d'expansion thermostatiques. Dégivrache par gaz chaud. Cadres de portes chauffés pour empêcher l'accumulation de glace.



Mesa de refrigeración y congelación / Undercounter refrigerator and freezer / Desserte dessus de comptoir positive et négative

MODELO
MODELE
MODÈLE



BMPP 1500 II

BMPP 2000 II

BMPP 2500 II

BMPP 1500 BT

BMPP 2000 BT

BMPP 2500 BT

| Precio Price Prix | 2.340 € | 2.781 € | 3.280 € | 2.965 € | 3.492 € | 4.183 € |
|--|--|----------------------------|----------------------------|---|----------------------------|----------------------------|
| Medidas Measures [mm] Mesures | 1468 x 600 x 850 mm. | 1960 x 600 x 850 mm. | 2452 x 600 x 850 mm. | 1468 x 600 x 850 mm. | 1960 x 600 x 850 mm. | 2452 x 600 x 850 mm. |
| Temperatura Temperature Température | -2°C/+8°C | | | -18°C | | |
| Clase Climática Climatic class Classe climatique | 5 / 40° C | | | 4 / 38°C | | |
| Tensión/Frecuencia Electrical data Tension électrique | 230V/1ph/50Hz | | | | | |
| Controlador Controller Régulateur | Digital IP65 | | | | | |
| Material Material [EXT/INT] Matériel | AISI 304 | | | | | |
| Espesor Thickness Épaisseur | 70 | | | | | |
| Aislamiento Isolation Isolation | 40kg/m ³ / Free CFC's / Zero ODP-GWP | | | | | |
| Capacidad Capacity Capacité | 250 | 385 | 510 | 250 | 385 | 510 |
| Puertas Doors Portes | 2 | 3 | 4 | 2 | 3 | 4 |
| Nº parrillas / Guías Nº shelves / Slides Nº de grilles / Glissière | 2/2 [325x430] | 3/3 [325x430] | 4/4 [325x430] | 2/2 [325x430] | 3/3 [325x430] | 4/4 [325x430] |
| Sistema de frío Cooling System Système de froid | Monoblock ventilado / Forced air monoblock / Monoblock ventilé | | | | | |
| Desescarche Defrost Dégivrage | Parada compresor / Compressor off / Arrêt du compresseur | | | Gas caliente / Hot gas / Gaz chaud | | |
| Expansión Expansion Expansion | Capilar / Capillary / Capillaire | | | Válvula termostática / Expansion valve / Détendeur thermostatique | | |
| Potencia Power Puissance | 260 | 260 | 446 | 443 | 472 | 561 |
| Potencia frig. Cooling capacity Puissance Frig. | 370 | 370 | 690 | 445 | 445 | 540 |
| Consumo Consumption Consommation | 1,55 | 1,80 | 2,05 | 4,02 | 6,57 | 6,78 |
| Clase energética Energy class Classe Énerg. | A | | | C | | C |
| Refrigerante Refrigerant Gaz | R-290 | | | | | |
| Opcional Optional Options | 115V/1ph/60Hz Sin incremento / No increase / Sans supplément | | | 115V/1ph/60Hz +3% | | |
| | 230V/1ph/60Hz Sin incremento / No increase / Sans supplément | | | 230V/1ph/60Hz Sin incremento / No increase / Sans supplément | | |
| | Parrilla / Wire shelf / Grille [502X07] 39 € Cerradura / Lock / Serrure [506X209; 506X210] 44 € Juego de guías / Slides / Jeu de Glissières [GUIACO115430, GUIACO215430] 35 € Grupo lado contrario / Group opposite side / Groupe opposé [L] 76 € | | | Ruedas / Casters / Roulettes [705X16=2; 705X17=2] 169 € Sin peto trasero / Without backsplash / Sans dossieret Sin incremento / No increase / Sans supplément | | |
| | Kit cajones / Drawer Kit / Kit tiroirs BM 1/2 x 200 [JCAJ17BM1/2] 516 € BM 1/3 x 100 [JCAJ17BM1/3] 768 € BM 2/3 + BM 1/3 [JCAJ17BM2/3] 643 € | | | | | |

Serie / Series / Série **600**

+Info: www.infrico.com

BMPP 2000 II



Controlador digital IP 65.
Digital control IP65
Contrôleur digital IP 65.





Opcional: Manejo control digital por WiFi o Bluetooth*
Optional: Operating digital control by WiFi or Bluetooth*

Circulación optimizada del aire
Optimal air flow
Circulation d'air optimisée



Sistema de ventilación de condensación frontal
Front breathing condensation system
Système de ventilation à condensation frontale

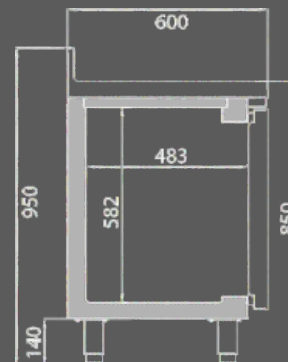

Refuerzo con Omegas.
Omega reinforcement.
Renforcement avec Omegas.



Kit 2 cajones
2 drawers kit
Kit 2 tiroirs

BM 1/2 x 200



Kit 2 cajones
2 drawers kit
Kit 2 tiroirs

BM 2/3x300 +
BM 1/3x100



Kit 3 cajones
3 drawers kit
Kit 3 tiroirs

BM 1/3x100

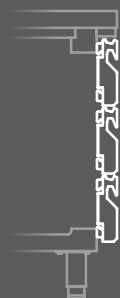

1/2
302 x 418 x 205

2/3
302 x 418 x 307

1/3
302 x 418 x 105









KIT CAJONES / DRAWERS KIT / KIT TIROIRS (MOD. II)

Mesa refrigerada puertas cristal / Glass Door undercounter refrigerator / Desserte dessus de comptoir posit. portes vitrées

Mesa refrigerada con fregadero / Sink undercounter refrigerator / Desserte dessus de comptoir posit. avec évier

F= Fregadero / Sink / Evier

| MODELO MODELE MODÈLE |  |  |  |  |  |  |
|--|---|---|---|--|---|---|
| Precio Price Prix | 2.774 € | 3.396 € | 4.108 € | 2.686 € | 3.068 € | 3.612 € |
| Medidas Measures [mm] Mesures | 1468 x 600 x 850 mm. | 1960 x 600 x 850 mm. | 2452 x 600 x 850 mm. | 1468 x 600 x 850 mm. | 1960 x 600 x 850 mm. | 2452 x 600 x 850 mm. |
| Temperatura Temperature Température | +2°C/+6°C | | | -2°C/+8°C | | |
| Clase Climática Climatic class Classe climatique | 4 / 38°C | | | 5 / 40°C | | |
| Tensión/Frecuencia Electrical data Tension électrique | 230V/1ph/50Hz | | | | | |
| Controlador Controller Régulateur | Digital IP65 | | | | | |
| Material Material [EXT/INT] Matériel | AISI 304 | | | | | |
| Espesor Thickness Épaisseur | 70 | | | | | |
| Aislamiento Isolation Isolation | 40kg/m ³ / Free CFC's / Zero ODP-GWP | | | | | |
| Capacidad Capacity Capacité | 250 | 385 | 510 | 250 | 385 | 510 |
| Puertas Doors Portes | 2 | 3 | 4 | 2 | 3 | 4 |
| Nº parrillas / Guías Nº shelves / Slides Nº de grilles / Glissière | 2/2 [325x430] | 3/3 [325x430] | 4/4 [325x430] | 2/2 [325x430] | 3/3 [325x430] | 4/4 [325x430] |
| Sistema de frío Cooling System Système de froid | Monoblock ventilado / Forced air monoblock / Monoblock ventilé | | | | | |
| Desescarche Defrost Dégivrage | Parada compresor / Compressor off / Arrêt du compresseur | | | | | |
| Expansión Expansion Expansion | Capilar / Capillary / Capillaire | | | | | |
| Potencia Power Puissance | 270 | 382 | 387 | 260 | 260 | 446 |
| Potencia frig. Cooling capacity Puissance Frig. | 370 | 690 | 690 | 370 | 370 | 690 |
| Consumo Consumption Consommation | - | - | - | 1,55 | 1,80 | 2,05 |
| Clase energética Energy class Classe Énerg. | - | | | A | A | A |
| Refrigerante Refrigerant Gaz | R-290 | | | | | |
| Opcional Optional Options | <p>Juego de guías / Slides / Jeu de Glissières [GUIAC0115430, GUIAC0215430] 35 € Grupo lado contrario / Group opposite side / Groupe opposé [L] 76 € Sin incremento / No increase / Sans supplément Sin incremento / No increase / Sans supplément Kit cajones / Drawer Kit / Kit tiroirs BM 1/2 x 200 [JCAJ17BM1/2] 516 € BM 1/3 x 100 [JCAJ17BM1/3] 768 € BM 2/3 + BM 1/3 [JCAJ17BM2/3] 643 €</p> | | | | | |
| | Parrilla / Wire shelf / Grille [502X43] Cerradura / Lock / Serrure [506X60] 49 € Iluminación Led RGB con cambio de color [por puerta] / Led lighting RGB change of colour [per door] / LED RGB avec changement de couleur [par porte] 61 € | | | Parrilla / Wire shelf / Grille [502X07] 39 € Cerradura / Lock / Serrure [506X209; 506X210] 44 € | | |

Serie / Series / Série **600**

+Info: www.infrico.com

Doble cristal templado bajo emisivo más carga Argón 4-27-4
 Double tempered glass low-e + Argón 4-27-4
 Double vitrage trempé à faible émissivité avec^o

BMPP 1500 CR

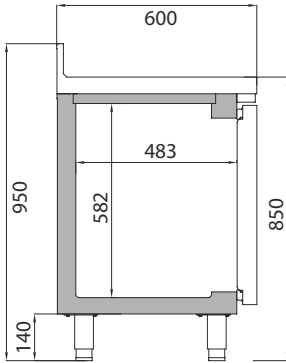

F= Fregadero / Sin
BMPPF 15



Opcional
 Optional
 Option

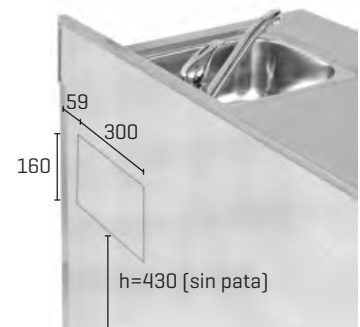

Kit 2 cajones
 2 drawers kit
 Kit 2 tiroirs

BM 1/2 x 200

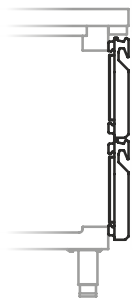

Kit 2 cajones
 2 drawers kit
 Kit 2 tiroirs

BM 2/3x300 +
 BM 1/3x100

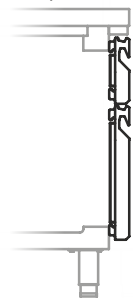

Kit 3 cajones
 3 drawers kit
 Kit 3 tiroirs

BM 1/3x100

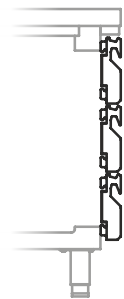

1/2 **2/3** **1/3**
302 x 418 x 205 **302 x 418 x 307** **302 x 418 x 105**



KIT CAJONES / DRAWERS KIT / KIT TIROIRS (MOD. CR)

Mesa refrigerada pre-instalada / Remote undercounter refrigerator / Desserte dessus de comptoir groupe à distance

Mesa refrigerada ensaladas / Salad prep refrigerator undercounter / Desserte dessus de comptoir posit. prép. salades

Ensaladas / Salad prep / Prép. salades

MODELO
MODELE
MODÈLE



BMPP 1500 GR

BMPP 2000 GR

BMPP 1500 GRBT

BMPP 2000 GRBT

BMPP 1500 EN

BMPP 2000 EN

| Precio Price Prix | 1.931 € | 2.376 € | 2.126 € | 2.571 € | 3.296 € | 3.821 € |
|--|--|----------------------------|--|----------------------------|--|-----------------------------|
| Medidas Measures [mm] Mesures | 1240 x 600 x 850 mm. | 1732 x 600 x 850 mm. | 1240 x 600 x 850 mm. | 1732 x 600 x 850 mm. | 1468 x 600 x 1100 mm. | 1960 x 600 x 1100 mm. |
| Temperatura Temperature Température | 0°C/+6°C | | -18°C | | 0°C/+6°C | |
| Clase Climática Climatic class Classe climatique | | | - | | 4 / 38°C | |
| Tensión/Frecuencia Electrical data Tension électrique | 230V/1ph/50Hz | | | | | |
| Controlador Controller Régulateur | Digital IP65 | | | | | |
| Material Material [EXT/INT] Matériel | AISI 304 | | | | | |
| Espesor Thickness Épaisseur | 70 | | | | | |
| Aislamiento Isolation Isolation | 40kg/m ³ / Free CFC's / Zero ODP-GWP | | | | | |
| Capacidad Capacity Capacité | 250 | 385 | 250 | 385 | 250+50 | 385+70 |
| Puertas Doors Portes | 2 | 3 | 2 | 3 | 2 | 3 |
| Nº parrillas / Guías Nº shelves / Slides Nº de grilles / Glissière | 2/2 {325x430} | 3/3 {325x430} | 2/2 {325x430} | 3/3 {325x430} | 2/2 {325x430} | 3/3 {325x430} |
| Sistema de frío Cooling System Système de froid | Monoblock ventilado / Forced air monoblock / Monoblock ventilé | | | | | |
| Desescarche Defrost Dégivrage | Parada compresor / Compressor off / Arrêt du compresseur | | Gas caliente / Hot gas / Gaz chaud | | Parada compresor / Compressor off / Arrêt du compresseur | |
| Expansión Expansion Expansion | Opcional / Optional / Options | | | | Capilar / Capillary / Capillaire | |
| Potencia Power Puissance | | | - | | 249 | 249 |
| Potencia frig. Cooling capacity Puissance Frig. | Recom. 370 | Recom. 370 | Recom. 445 | Recom. 445 | 370 | 370 |
| Consumo Consumption Consommation | - | | | | | |
| Clase energética Energy class Classe Énerg. | - | | | | | |
| Refrigerante Refrigerant Gaz | - | | | | R-290 | |
| Opcional Optional Options | Juego de guías / Slides / Jeu de Glissières [GUIAC0115430, GUIAC0215430] 35 € Cerradura / Lock / Serrure [506X209; 506X210] 44 € Parrilla / Wire shelf / Grille [502X07] 39 € | | | | | |
| | Válvula expansión [especificar refrig.] / Expansion valve [specify refrig.] / Détendeur [spécifier le gaz] Puerta de cristal [unidad] / Glass door [unit] / Porte vitrée [unité] [PUE17IDGN-PUE17IIGN][GR] 122 € | | | | Ruedas / Casters / Roulettes (705X16=2; 705X17=2) BMPP 1500 EN [501X16] = 8 169 € BMPP 2000 EN [501X16] = 11 407 € 560 € | |
| | Kit cajones / Drawer Kit / Kit tiroirs BM 1/2 x 200 [JCAJ17BM1/2] 516 € BM 1/3 x 100 [JCAJ17BM1/3] 768 € BM 2/3 + BM 1/3 [JCAJ17BM2/3] 643 € | | Kit cajones / Drawer Kit / Kit tiroirs Consultar / On request / À la demande 115V/1ph/60Hz +3% 230V/1ph/60Hz Sin incremento / No increase / Sans supplément | | Kit cajones / Drawer Kit / Kit tiroirs BM 1/2 x 200 [JCAJ17BM1/2] 516 € BM 1/3 x 100 [JCAJ17BM1/3] 768 € BM 2/3 + BM 1/3 [JCAJ17BM2/3] 643 € | |
| | | | | | | |

Serie / Series / Série **600**

+Info: www.infrico.com

Video del producto

Product Video

Vidéo du produit



Infrico Youtube

Refuerzo con Omegas.
Omega reinforcement.
Renforcement avec Omegas.

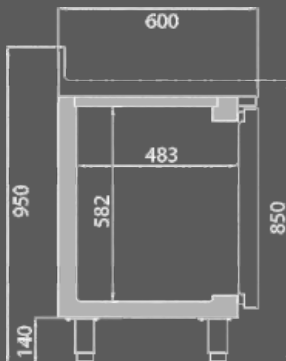
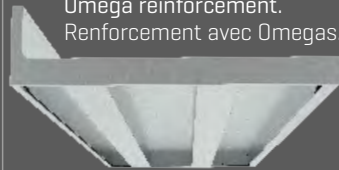

Posibilidad de acceso frontal y lateral para una mejor manipulación.
Front and lateral access for better handling
Possibilité d'accès frontal et latéral pour une meilleure manipulation.



Refrigeración estática en la cuba
Static cooling in the tank
Refroidissement statique supérieur



BMPP 2000 EN



Kit 2 cajones
2 drawers kit
Kit 2 tiroirs

BM 1/2 x 200

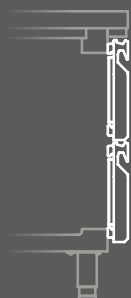

Kit 2 cajones
2 drawers kit
Kit 2 tiroirs

BM 2/3x300 +
BM 1/3x100



Kit 3 cajones
3 drawers kit
Kit 3 tiroirs

BM 1/3x100











1/2 2/3 1/3
302 x 418 x 205 302 x 418 x 307 302 x 418 x 105



KIT CAJONES / DRAWERS KIT / KIT TIROIRS (MOD. GR - EN)

Mesa baja refrigeración y congelación / Counter bases refrigerator and freezer / Soubassement gastronorme positif et negative

| MODELO MODELE MODÈLE |  |  |  |  |  |  |  |  |  |
|---|--|---|---|---|---|---|---|---|---|
| | MSG 1000 | MSG 1400 | MSG 1600 | MSG 2000 | MSG 2400 | MSG 1000 BT | MSG 1400 BT | MSG 1600 BT | MSG 2000 BT |
| Precio Price Prix | 2.351 € | 3.042 € | 3.283 € | 3.864 € | 4.791 € | 2.939 € | 3.803 € | 4.104 € | 4.830 € |
| Medidas Measures [mm] Mesures | 1000 x 700 x 650 mm. | 1400 x 700 x 650 mm. | 1600 x 700 x 650 mm. | 2000 x 700 x 650 mm. | 2400 x 700 x 650 mm. | 1000 x 700 x 650 mm. | 1400 x 700 x 650 mm. | 1600 x 700 x 650 mm. | 2000 x 700 x 650 mm. |
| Temperatura Temperature Température | -2°C/+8°C | | | | | -18°C | | | |
| Clase Climática Climatic class Classe climatique | 5 / 40°C | | | | | 4 / 38°C | | | |
| Tensión/Frecuencia Electrical data Tension électrique | 230V/1ph/50Hz | | | | | | | | |
| Controlador Controller Régulateur | Digital IP65 | | | | | | | | |
| Material Material [EXT/INT] Matériel | AISI 304 | | | | | | | | |
| Espesor Thickness Épaisseur | 70 | | | | | | | | |
| Aislamiento Isolation Isolation | 40kg/m ³ / Free CFC's / Zero ODP-GWP | | | | | | | | |
| Capacidad Capacity Capacité | 100 | 190 | 225 | 310 | 435 | 100 | 190 | 225 | 310 |
| Cajones Drawers Tiroirs | 2 | 4 | 4 | 6 | 8 | 2 | 4 | 4 | 6 |
| Nº parrillas / Guías Nº shelves / Slides Nº de grilles / Glissière | - | | | | | | | | |
| Sistema de frío Cooling System Système de froid | Monoblock ventilado / Forced air monoblock / Monoblock ventilé | | | | | | | | |
| Desescarche Defrost Dégivrage | Parada compresor / Compressor off / Arrêt du compresseur | | | | | Gas caliente / Hot gas defrost / Gaz chaud | | | |
| Expansión Expansion Expansion | Capilar / Capillary / Capillaire | | | | | Válvula de expansión termostática / Thermostatic expansion valve / Détendeur thermostatique | | | |
| Potencia Power Puissance | 205 | 210 | | | 368 | 443 | 443 | 472 | 561 |
| Potencia frig. Cooling capacity Puissance Frig. | 370 | | | | 690 | 445 | 445 | 540 | 540 |
| Consumo Consumption Consommation | 0,98 | 1,23 | 1,33 | 1,61 | 1,77 | 4,02 | 4,02 | 6,57 | 6,78 |
| Clase energética Energy class Classe Énerg. | A | A | A | B | B | C | C | D | D |
| Refrigerante Refrigerant Gaz | R-290 | | | | | | | | |
| Opcional Optional Options | Cerradura / Lock / Serrure [506X209; 506X210] | | | | | 44 € | | | |
| | Puerta [unidad] / Door [unit] / Porte [unité] [PUE17ISN] | | | | | -242 € | | | |
| | Cajón / Drawer / Tiroir 2/3x300 [JCAJ17SN2/3] Sin incremento / Without supplement / Sans supplément | | | | | | | | |
| | 115V/1ph/60Hz 230V/1ph/60Hz Sin incremento / No increase / Sans supplément | | | | | 115V/1ph/60Hz 230V/1ph/60Hz +3% Sin incremento / No increase / Sans supplément | | | |

MSG 2000



Refuerzo con Omegas.
Omega reinforcement.
Renforcement avec Omegas.

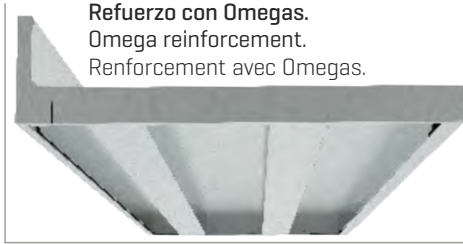

Controlador digital IP 65.
Digital control IP65
Contrôleur digital IP 65.



Opcional: Manejo control digital por WiFi o Bluetooth*

Optional: Operating digital control by WiFi or Bluetooth*

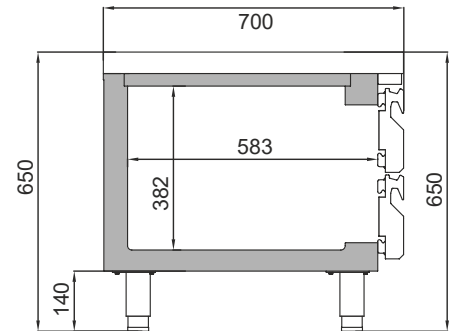

MSG 1600

Puertas opcionales
Optionals doors
Portes en option



Mesa refrigeración y congelación / Undercounter refrigerator and freezer / Desserte gastronomique positive et négative

MODELO
MODELE
MODÈLE



BMGN 1470 II



BMGN 1960 II



BMGN 2450 II



BMGN 1470 BT



BMGN 1960 BT



BMGN 2450 BT

| Precio Price Prix | 2.666 € | | 3.156 € | | 3.733 € | | 3.524 € | | 4.148 € | | 4.829 € | |
|--|---|--|----------------------------|--|----------------------------|--|---|--|----------------------------|--|----------------------------|--|
| Medidas Measures [mm] Mesures | 1468 x 700 x 850 mm. | | 1960 x 700 x 850 mm. | | 2452 x 700 x 850 mm. | | 1468 x 700 x 850 mm. | | 1960 x 700 x 850 mm. | | 2452 x 700 x 850 mm. | |
| Temperatura Temperature Température | -2°C/+8°C | | | | | | -18°C | | | | | |
| Clase Climática Climatic class Classe climatique | 5 / 40°C | | | | | | 4 / 38°C | | | | | |
| Tensión/Frecuencia Electrical data Tension électrique | 230V/1ph/50Hz | | | | | | | | | | | |
| Controlador Controller Régulateur | Digital IP65 | | | | | | | | | | | |
| Material Material [EXT/INT] Matériel | AISI 304 | | | | | | | | | | | |
| Espesor Thickness Épaisseur | 70 | | | | | | | | | | | |
| Aislamiento Isolation Isolation | 40kg/m ³ / Free CFC's / Zero ODP-GWP | | | | | | | | | | | |
| Capacidad Capacity Capacité | 305 | | 465 | | 630 | | 305 | | 465 | | 630 | |
| Puertas Doors Portes | 2 | | 3 | | 4 | | 2 | | 3 | | 4 | |
| Nº parrillas / Guías Nº shelves / Slides Nº de grilles / Glissière | 2/10 {325x530} | | 3/15 {325x530} | | 4/20 {325x530} | | 2/10 {325x530} | | 3/15 {325x530} | | 4/20 {325x530} | |
| Sistema de frío Cooling System Système de froid | Monoblock ventilado / Forced air monoblock / Monoblock ventilé | | | | | | | | | | | |
| Desescarche Defrost Dégivrage | Parada compresor / Compressor off / Arrêt du compresseur | | | | | | Gas caliente / Hot gas defrost / Gaz chaud | | | | | |
| Expansión Expansion Expansion | Capilar / Capillary / Capillaire | | | | | | Válvula de expansión termostática / Thermostatic expansion valve / Détendeur thermostatique | | | | | |
| Potencia Power Puissance | 210 | | 368 | | 508 | | 597 | | 711 | | | |
| Potencia frig. Cooling capacity Puissance Frig. | 570 | | 690 | | 445 | | 540 | | 640 | | | |
| Consumo Consumption Consommation | 1,50 | | 1,95 | | 2,25 | | 5,45 | | 7,71 | | 9,03 | |
| Clase energética Energy class Classe Énerg. | A | | | | | | C | | D | | D | |
| Refrigerante Refrigerant Gaz | R-290 | | | | | | | | | | | |
| Opcional Optional Options | Sin peto trasero / Without backsplash / Sans dossieret sin incremento / without supplement / sans supplément | | | | | | | | | | | |
| | Parrilla / Wire shelf / Grille [502X12] 45 € | | | | | | | | | | | |
| Juego de guías / Slides / Jeu de Glissières [GUIAC0115530, GUIAC0215530] 38 € | | | | | | | | | | | | |
| Cerradura / Lock / Serrure [506X209; 506X210] 44 € | | | | | | | | | | | | |
| Grupo lado contrario / Group opposite side / Groupe opposé [L] 76 € | | | | | | | | | | | | |
| Ruedas / Casters / Roulettes [705X16=2; 705X17=2] 169 € | | | | | | | | | | | | |
| Kit cajones / Drawer Kit / Kit tiroirs | | | | | | | | | | | | |
| BMGN 1/2 x 200 [JCAJ17GN1/2] 643 € | | | | | | | | | | | | |
| BMGN 1/3 x 100 [JCAJ17GN1/3] 954 € | | | | | | | | | | | | |
| BMGN 2/3 + BMGN 1/3 [JCAJ17GN2/3] 711 € | | | | | | | | | | | | |
| 115V/1ph/60Hz + 3% | | | | | | | | | | | | |
| 230V/1ph/60Hz Sin incremento / No increase / Sans supplément | | | | | | | | | | | | |

Serie / Series / Série **GN1/1 700**

+Info: www.infrico.com

BMGN 1470 II



Refuerzo con Omegas.
Omega reinforcement.
Renforcement avec Omegas.

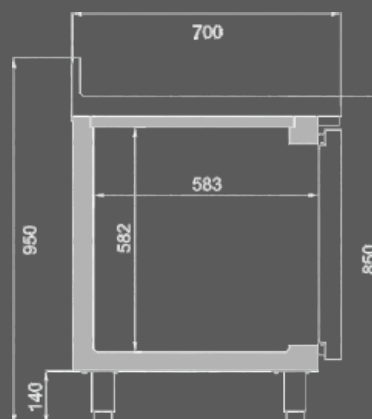
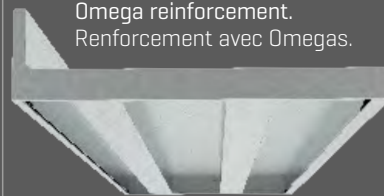

Kit 2 cajones
2 drawers kit
Kit 2 tiroirs

BM 1/2 x 200



Kit 2 cajones
2 drawers kit
Kit 2 tiroirs

BM 2/3x300 +
BM 1/3x100



Kit 3 cajones
3 drawers kit
Kit 3 tiroirs

BM 1/3x100

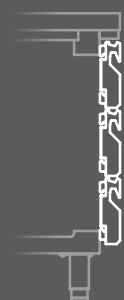

1/2
302 x 518 x 205

2/3
302 x 518 x 307

1/3
302 x 518 x 105



KIT CAJONES / DRAWERS KIT / KIT TIROIRS (MOD. II)

Mesa refrigeración y congelación / Undercounter refrigerator and freezer / Desserte gastronomique positive et négative

MODELO
MODELE
MODÈLE

NEW



BMGN 1470 A+

A+

NEW



BMGN 1960 A+

A+
INVERTER

| | | |
|--|--|----------------------------|
| Precio Price Prix | 3.253 € | 3.850 € |
| Medidas Measures Mesures (mm) | 1468 x 700 x 850 mm. | 1960 x 700 x 850 mm. |
| Temperatura Temperature Température (°C) | -2°C/+8°C | |
| Clase Climática Climatic class Classe climatique (°C) | 5 / 40°C | |
| Tensión/Frecuencia Electrical data Tension électrique | 230V/1ph/50Hz | |
| Controlador Controller Régulateur | Digital IP65 | |
| Material Material Matériel (EXT/INT) | AISI 304 | |
| Espesor Thickness Épaisseur (mm) | 70 | |
| Aislamiento Isolation Isolation (mm) | 40kg/m ³ / Free CFC's / Zero ODP-GWP | |
| Capacidad Capacity Capacité (L) | 305 | 465 |
| Puertas Doors Portes | 2 | 3 |
| Nº parrillas / Guías Nº shelves / Slides Nº de grilles / Glissière | 2/10 [325x530] | 3/15 [325x530] |
| Sistema de frío Cooling System Système de froid | Monoblock ventilado / Forced air monoblock / Monoblock ventilé | |
| Desescarche Defrost Dégivrage | Parada compresor / Compressor off / Arrêt du compresseur | |
| Expansión Expansion Expansion | Capilar / Capillary / Capillaire | |
| Potencia Power Puissance (W) | 210 | 368 |
| Potencia frig. Cooling capacity Puissance Frig. (W A -10°C) | 570 | 690 |
| Consumo Consumption Consommation (kWh/ 24h) | 0,82 | 1,01 |
| Clase energética Energy class Classe Énerg. | A+ | |
| Refrigerante Refrigerant Gaz | R-290 | |
| Opcional Optional Options | <p>Sin peto trasero / Without backsplash / Sans dosseret Sin incremento / No increase / Sans supplément</p> <p>Parrilla / Wire shelf / Grille [502X12] 45 €</p> <p>Juego de guías / Slides / Jeu de Glissières [GUIAC0115530, GUIAC0215530] 38 €</p> <p>Cerradura / Lock / Serrure [506X209; 506X210] 44 €</p> <p>Grupo lado contrario / Group opposite side / Groupe opposé [L] 76 €</p> <p>115V/1ph/60Hz Sin incremento / No increase / Sans supplément</p> <p>230V/1ph/60Hz Sin incremento / No increase / Sans supplément</p> <p>Ruedas / Casters / Roulettes [705X16=2; 705X17=2] 169 €</p> | |

osmarc.es
NEW

Serie / Series / Série **GN1/1 700**

+Info: www.infrico.com

Clase energ.
Energy class
Classe Énerg.

A+

INVERTER

BMGN 1960 A+





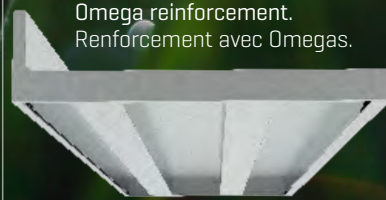



Refuerzo con Omegas.
Omega reinforcement.
Renforcement avec Omegas.



Mesa refrigerada puertas cristal / Glass Door undercounter refrigerator / Desserte dessus de comptoir posit. portes vitrées

Mesa refrigerada con fregadero / Sink undercounter refrigerator / Desserte dessus de comptoir posit. avec évier

F= Fregadero / Sink / Evier

| MODELO MODEL MODÈLE |  |  |  |  |  |  |
|---|---|---|---|--|---|---|
| | BMGN 1470 CR | BMGN 1960 CR | BMGN 2450 CR | BMGN 1470 F | BMGN 1960 F | BMGN 2450 F |
| Precio Price Prix | 3.117 € | 3.808 € | 4.609 € | 2.914 € | 3.437 € | 3.921 € |
| Medidas Measures [mm] Mesures | 1468 x 700 x 850 mm. | 1960 x 700 x 850 mm. | 2452 x 700 x 850 mm. | 1468 x 700 x 850 mm. | 1960 x 700 x 850 mm. | 2452 x 700 x 850 mm. |
| Temperatura Temperature Température | +2°C/+6°C | | | -2°C/+8°C | | |
| Clase Climática Climatic class Classe climatique | 4 / 38°C | | | 5 / 40°C | | |
| Tensión/Frecuencia Electrical data Tension électrique | 230V/1ph/50Hz | | | | | |
| Controlador Controller Régulateur | Digital IP65 | | | | | |
| Material Material [EXT/INT] Matériel | AISI 304 | | | | | |
| Espesor Thickness Épaisseur | 70 | | | | | |
| Aislamiento Isolation Isolation | 40kg/m ³ / Free CFC's / Zero ODP-GWP | | | | | |
| Capacidad Capacity Capacité | 305 | 465 | 630 | 305 | 465 | 630 |
| Puertas Doors Portes | 2 | 3 | 4 | 2 | 3 | 4 |
| Nº parrillas / Guías Nº shelves / Slides Nº de grilles / Glissière | 2/10 [325x530] | 3/15 [325x530] | 4/20 [325x530] | 2/10 [325x530] | 3/15 [325x530] | 4/20 [325x530] |
| Sistema de frío Cooling System Système de froid | Monoblock ventilado / Forced air monoblock / Monoblock ventilé | | | | | |
| Desescarche Defrost Dégivrage | Parada compresor / Compressor off / Arrêt du compresseur | | | | | |
| Expansión Expansion Expansion | Capilar / Capillary / Capillaire | | | | | |
| Potencia Power Puissance | 377 | 382 | 387 | 210 | 368 | |
| Potencia frig. Cooling capacity Puissance Frig. | 690 | 690 | 690 | 370 | 690 | |
| Consumo Consumption Consommation | - | | | 1,50 | 1,95 | 2,25 |
| Clase energética Energy class Classe Énerg. | - | | | A | A | A |
| Refrigerante Refrigerant Gaz | R-290 | | | | | |
| Opcional Optional Options | Juego de guías / Slides / Jeu de Glissières [GUIAC0115530, GUIAC0215530] 36 € | | | | | |
| | Parrilla doble tupida / Extradense wire shelf / Grille renforcée [502X62] 53 € Parrilla inoxidable / Stainless steel wire shelf / Grille Inox [502X46] 76 € Iluminación Led RGB con cambio de color [por puerta] / Led lighting RGB change of colour [per door] / LED RGB avec changement de couleur [par porte] 67 € Cerradura / Lock / Serrure [506X60] 61 € | | | Parrilla / Wire shelf / Grille [502X12] 45 € Cerradura / Lock / Serrure [506X209; 506X210] 44 € Grupo lado contrario / Group opposite side / Groupe opposé [L] 76 € Kit cajones / Drawer Kit / Kit tiroirs BMGN 1/2 x 200 [JCAJ17GN1/2] 643 € BMGN 1/3 x 100 [JCAJ17GN1/3] 954 € BMGN 2/3 + BMGN 1/3 [JCAJ17GN2/3] 711 € | | |

Serie / Series / Série **GN1/1 700**

+Info: www.infrico.com



F= Fregadero
BMGN F

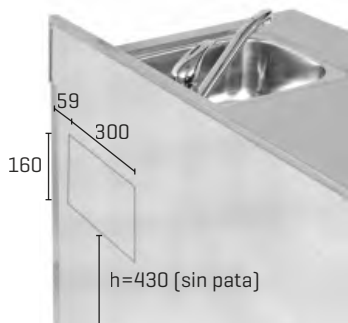

Opcional: Manejo control digital por WiFi o  Bluetooth*

Optional: Operating digital control by WiFi or  Bluetooth*

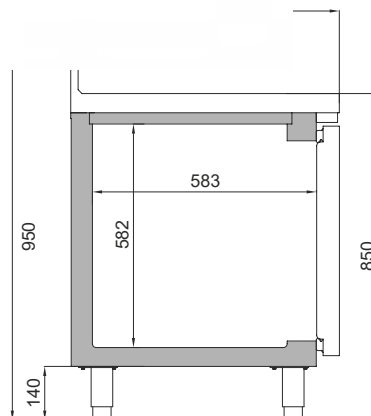

Kit 2 cajones
2 drawers kit
Kit 2 tiroirs

BM 1/2 x 200



Kit 2 cajones
2 drawers kit
Kit 2 tiroirs

BM 2/3x300 +
BM 1/3x100



Kit 3 cajones
3 drawers kit
Kit 3 tiroirs

BM 1/3x100

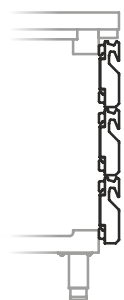

1/2
302 x 518 x 205

2/3
302 x 518 x 307

1/3
302 x 518 x 105



KIT CAJONES / DRAWERS KIT / KIT TIROIRS (MOD. F)

Mesa refrigerada pre-instalada / Remote undercounter refrigerator / Desserte dessus de comptoir groupe á distance

Mesa refrigerada central puertas a dos caras / Pass thru undercounter refrigerator / Desserte gastronomique positive traversante

Dos caras / Pass-thru / Traversante

MODELO
MODELE
MODÈLE



BMGN 1470 GR

BMGN 1960 GR

BMGN 2450 GR

BMGN 1470 GRBT

BMGN 1960 GRBT

BMGN 2450 GRBT

BMGN 1470 PDC

BMGN 1960 PDC

| Precio Price Prix | 2.074 € | 2.492 € | 2.985 € | 2.269 € | 2.687 € | 3.180 € | 3.191 € | 3.724 € |
|--|--|----------------------------|----------------------------|---|----------------------------|----------------------------|--|----------------------------|
| Medidas Measures [mm] Mesures | 1240 x 700 x 850 mm. | 1732 x 700 x 850 mm. | 2224 x 700 x 850 mm. | 1240 x 700 x 850 mm. | 1732 x 700 x 850 mm. | 2224 x 700 x 850 mm. | 1468 x 700 x 850 mm. | 1960 x 700 x 850 mm. |
| Temperatura Temperature Température | -2°C/+8°C | | | -18°C | | | -2°C/+8°C | |
| Clase Climática Climatic class Classe climatique | - | | | - | | | 5 / 40°C | |
| Tensión/Frecuencia Electrical data Tension électrique | 230V/1ph/50Hz | | | | | | | |
| Controlador Controller Régulateur | Digital IP65 | | | | | | | |
| Material Material [EXT/INT] Matériel | Inox AISI 304 | | | | | | | |
| Espesor Thickness Épaisseur | 70 | | | | | | | |
| Aislamiento Isolation Isolation | 40kg/m ³ / Free CFC's / Zero ODP-GWP | | | | | | | |
| Capacidad Capacity Capacité | 305 | 465 | 630 | 305 | 465 | 630 | 290 | 440 |
| Puertas Doors Portes | 2 | 3 | 4 | 2 | 3 | 4 | 4 | 6 |
| Nº parrillas / Guías Nº shelves / Slides Nº de grilles / Glissière | 2/10 (325x530) | 3/15 (325x530) | 4/20 (325x530) | 2/10 (325x530) | 3/15 (325x530) | 4/20 (325x530) | 2/10 (325x530) | 3/15 (325x530) |
| Sistema de frío Cooling System Système de froid | - | | | | | | Monoblock ventilado / Forced air monoblock / Monoblock ventilé | |
| Desescarche Defrost Dégivrage | Parada compresor / Compressor off / Arrêt du compresseur | | | Gas caliente / Hot gas / Gaz chaud | | | Parada compresor / Compressor off / Arrêt du compresseur | |
| Expansión Expansion Expansion | - | | | | | | Capilar / Capillary / Capillaire | |
| Potencia Power Puissance | - | | | - | | | 210 | 368 |
| Potencia frig. Cooling capacity Puissance Frig. | 343 | 690 | 690 | 445 | 540 | 640 | 370 | 690 |
| Consumo Consumption Consommation | - | | | - | | | 1,50 | 1,95 |
| Clase energética Energy class Classe Énerg. | - | | | - | | | A | A |
| Refrigerante Refrigerant Gaz | - | | | | | | R-290 | |
| Opcional Optional Options | Puerta de cristal / Glass door / Porte vitrée [PUE17IDGN-PUE17IIGN] Cerradura / Lock / Serrure [506X209; 506X210] Parrilla / Wire shelf / Grille [502X12] | | | | | | 122 € | |
| | Kit cajones / Drawer Kit / Kit tiroirs BMGN 1/2 x 200 [JCAJ17GN1/2] 643 € BMGN 1/3 x 100 [JCAJ17GN1/3] 954 € BMGN 2/3 + BMGN 1/3 [JCAJ17GN2/3] 711 € | | | Kit cajones / Drawer Kit / Kit tiroirs Consultar / On request / À la demande 115V/1ph/60Hz + 3% 230V/1ph/60Hz Sin incremento / No increase / Sans supplément | | | Juego de guías / Slides / Jeu de Glissières [GUIAC03505] 38 € | |
| | Válvula de expansión (especificar refrigerante) Expansion valve [specify refrigerant] Détendeur d'expansion [spécifier le gaz souhaité] Juego de guías / Slides / Jeu de Glissières [GUIAC0115530, GUIAC0215530] 38 € | | | | | | Parrilla inoxidable / Stainless steel wire shelf / Grille Inox [502X46] 76 € | |

Serie / Series / Série **GN1/1 700**

+Info: www.infrico.com



Possibilidad de acceso frontal y lateral para una mejor manipulación

Front and lateral access for better handling

Possibilité d'accès frontal et latéral pour une meilleure manipulation.

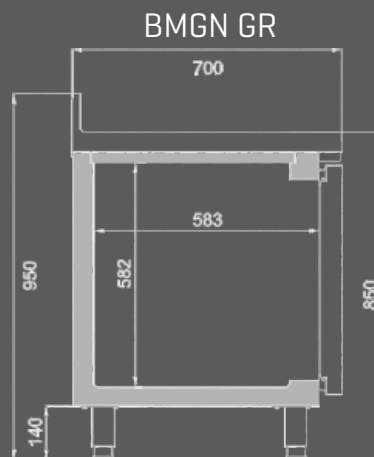
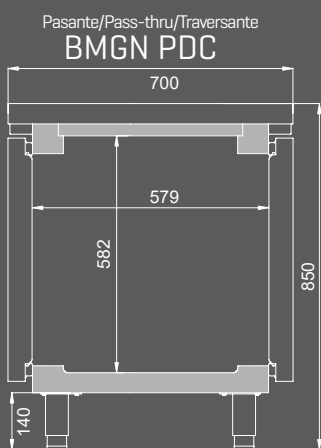

Kit 2 cajones
2 drawers kit
Kit 2 tiroirs

Kit 2 cajones
2 drawers kit
Kit 2 tiroirs

Kit 3 cajones
3 drawers kit
Kit 3 tiroirs

1/2
302 x 518 x 205

2/3
302 x 518 x 307

1/3
302 x 518 x 105

BM 1/2 x 200

**BM 2/3x300 +
BM 1/3x100**

BM 1/3x100

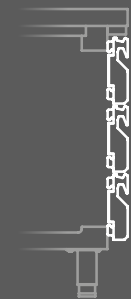

KIT CAJONES / DRAWERS KIT / KIT TIROIRS (MOD. GR)

Mesa refrigerada ensaladas / Salad prep refrigerator table / Desserte gastronomique positive préparation salades

Mesa refrigerada pizza / Pizza undercounter refrigerator / Desserte gastronomique positive préparation pizza

| | Ensalada / Salad / Salade | | Pizza / Pizza / Pizza | | |
|--|--|---------------------------------|---------------------------------|---------------------------------|---|
| MODELO MODELE MODÈLE | BMGN 1470 EN | BMGN 1960 EN | MPG 1490 | MPG 1980 | ME 1003 VIP |
| Precio Price Prix | 3.442 € | 4.070 € | 4.036 € | 4.953 € | 3.952 € |
| Medidas Measures [mm] Mesures | 1468 x 700 x 850/1100 mm. | 1960 x 700 x 850/1100 mm. | 1490 x 700 x 830/1417 mm. | 1980 x 700 x 830/1417 mm. | 1490 x 700 x 885/1417 mm. |
| Temperatura Temperature Température | 0°/+6°C. | | 0°/+6°C. +4°C/+8°C. | | |
| Clase Climática Climatic class Classe climatique | 4 / 38°C | | | | |
| Tensión/Frecuencia Electrical data Tension électrique | 230V/1ph/50Hz | | | | |
| Controlador Controller Régulateur | Digital IP65 | | | | |
| Material Material [EXT/INT] Matériel | Inox AISI 304 | | | | |
| Espesor Thickness Épaisseur | 70 | | | | |
| Aislamiento Isolation Isolation | 40kg/m ³ / Free CFC's / Zero ODP-GWP | | | | |
| Capacidad Capacity Capacité | 305+65 | 465+85 | 305+35 | 465+54 | 355+35 |
| Puertas Doors Portes | 2 | 3 | 2 | 3 | 3 |
| Nº parrillas / Guías Nº shelves / Slides Nº de grilles / Glissière | 2/10 [325x530] | 3/15 [325x530] | 2/10 [325x530] | 3/15 [325x530] | 3/9 [325x530] |
| Sistema de frío Cooling System Système de froid | Monoblock ventilado / Forced air monoblock / Monoblock ventilé | | | | |
| Desescarche Defrost Dégivrage | Parada compresor / Compressor off / Arrêt du compresseur | | | | |
| Expansión Expansion Expansion | Capilar / Capillary / Capillaire | | | | |
| Potencia Power Puissance | 210 | 368 | 369 | 553 | 503 |
| Potencia frig. Cooling capacity Puissance Frig. | 370 | 690 | 370+170 | 690+170 | 690+170 |
| Consumo Consumption Consommation | - | - | - | - | - |
| Clase energética Energy class Classe Énerg. | - | - | - | - | - |
| Refrigerante Refrigerant Gaz | R-290 | | | | |
| Opcional Optional Options | Parrilla / Wire shelf / Grille [502X12] | | | | 45 € |
| | Juego de guías / Slides / Jeu de Glissières [GUIAC0115530, GUIAC0215530] | | | | 38 € |
| | Cerradura / Lock / Serrure [506X209; 506X210] | | | | 44 € |
| | 230V/1ph/60Hz 115V/1ph/60Hz | | | | Sin incremento / No increase / Sans supplément |
| | [501X13] = 1 [501X11] = 6 | 311 € | [501X16] = 6 | 306 € | [501X16] = 6 306 € |
| | [501X13] = 1 [501X11] = 9 | 445 € | [501X13] = 1 [501X16] = 7 | 400 € | |
| | Ruedas / Casters / Roulettes [705X16=2; 705X17=2] | | | | 169 € |

Serie / Series / Série **GN1/1 700**

+Info: www.infrico.com

IMPORTANT: Las bandejas deben contener producto previamente refrigerado.
IMPORTANT: The trays should contain previously refrigerated product.
IMPORTANT: Les plateaux doivent contenir des produits préalablement réfrigérés.

Refrigeración estática en la cuba
 Static cooling in the tank
 Refroidissement statique supérieur

BMGN 1960 EN



Granito
 Granite worktop
 Granit



MPG 1980

Granito
 Granite worktop
 Granit



ME 1003 VIP

[501X16] = 6



[501X13] = 1 [501X16] = 7



[501X13] = 1 [501X11] = 6



[501X13] = 1 [501X11] = 9

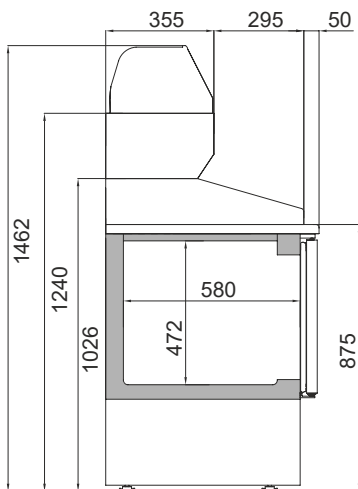

ME VIP

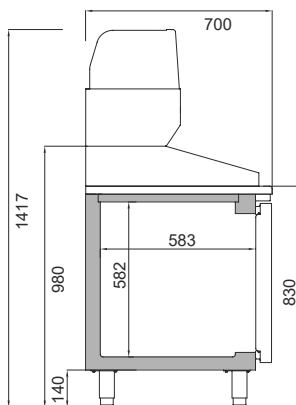

MPG

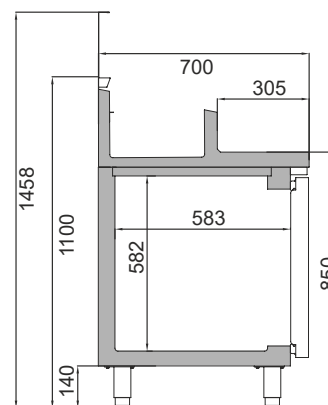

BMGN EN

Mesa refrigerada ensaladas / Salad prep refrigerator table / Desserte gastronomique positive préparation salades

MODELO
MODELE
MODÈLE



ME 1000 BAN



ME 1000 EN



ME 1000 II



ME 1000 PIZZA



ME 1000 KB

| Precio Price Prix | 2.364 € | 2.633 € | 2.317 € | 2.530 € | 2.390 € |
|---|---|--------------------------------|---|--|--|
| Medidas Measures [mm] Mesures | 978 x 700 x 890 mm. | 978 x 700 x 895/1050 mm. | 978 x 700 x 895 mm. | 978 x 700 x 875/1140 mm. | 978 x 700 x 865/1125 mm. |
| Temperatura Temperature Température | 0°C/+6°C. | | | | |
| Clase Climática Climatic class Classe climatique | 4 / 38°C | | | | |
| Tensión/Frecuencia Electrical data Tension électrique | 230V/1ph/50Hz | | | | |
| Controlador Controller Régulateur | Digital IP65 | | | | |
| Material Material [EXT/INT] Matériel | Inox AISI 304 | | | | |
| Espesor Thickness Épaisseur | 55 | | | | |
| Aislamiento Isolation Isolation | 40kg/m ³ / Free CFC's / Zero ODP-GWP | | | | |
| Capacidad Capacity Capacité | 230 | | | | |
| Puertas Doors Portes | 2 | | | | |
| Nº parrillas / Guías Nº shelves / Slides Nº de grilles / Glissière | 2/6 (325x530) | | | | |
| Sistema de frío Cooling System Système de froid | Ventilado / Forced air / Ventilé | | | | |
| Desescarche Defrost Dégivrage | Parada compresor / Compressor off / Arrêt du compresseur | | | | |
| Expansión Expansion Expansion | Capilar / Capillary / Capillaire | | | | |
| Potencia Power Puissance | 210 | | | | |
| Potencia frig. Cooling capacity Puissance Frig. | 370 | | | | |
| Consumo Consumption Consommation | - | | | | |
| Clase energética Energy class Classe Énerg. | - | | | | |
| Refrigerante Refrigerant Gaz | R-290 | | | | |
| Opcional Optional Options | Juego de guías / Slides / Jeu de Glissières [GUIACO115530; GUIACO215530] 34 € | | Parrilla / Wire shelf / Grille [502X12] 45 € | | |
| | Kit 2 cajones 1x1/2 + 1x1/3 (Modelo II) / Drawers kit 1x1/2 + 1x1/3 (Model II) 626 € | | Cerradura / Lock / Serrure [506X120; 506X121] 44 € | | |
| | Kit tiroirs 1x1/2 + 1x1/3 (Modèle II) [JCAJ17ME1/2] 112 € | | | | |
| | Puerta de cristal / Glass door / Porte vitrée [PUE17IDME10-PUE17IIME10] | | | | |
| | [501X11] = 6 [501X10] = 3 416 € | [501X16] = 5 256 € | - | [501X11] = 3 [501X10] = 1 169 € | [501X11] = 6 [501X10] = 3 396 € |

Serie / Series / Série **GN1/1 700**

+Info: www.infrico.com



[501X11] = 6 [501X10] = 3

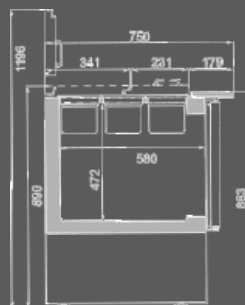

ME 1000 BAN

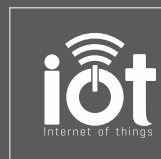

Opcional: Manejo control digital por WiFi o  Bluetooth®
Optional: Operating digital control by WiFi or  Bluetooth®



[501X16] = 5



ME 1000 EN

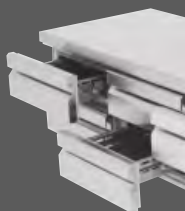

Kit 2 cajones 1x1/2 + 1x1/3 [Modelo II] /
Drawers kit 1x1/2 + 1x1/3 [Model II]
Kit tiroirs 1x1/2 + 1x1/3 [Modèle II]
[JCAJ17ME1/2]

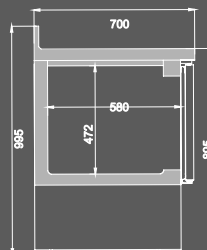

ME 1000 II



[501X11] = 3 [501X10] = 1



ME 1000 PIZZA



[501X11] = 6 [501X10] = 3



ME 1000 KB



Mesa refrigerada ensaladas / Salad prep refrigerator table / Desserte gastronomique positive préparation salades

MODELO
MODELE
MODÈLE



ME 1003 BAN



ME 1003 EN



ME 1003 II



ME 1003 PIZZA



ME 1003 KB

| Precio Price Prix | 2.824 € | 3.143 € | 2.659 € | 3.101 € | 2.945 € |
|---|---|---------------------------------|---|--|--|
| Medidas Measures [mm] Mesures | 1460 x 700 x 890 mm. | 1460 x 700 x 885/1050 mm. | 1460 x 700 x 895 mm. | 1460 x 700 x 875/1140 mm. | 1460 x 700 x 865/1125 mm. |
| Temperatura Temperature Température | 0°C/+6°C. | | | | |
| Clase Climática Climatic class Classe climatique | 4 / 38°C | | | | |
| Tensión/Frecuencia Electrical data Tension électrique | 230V/1ph/50Hz | | | | |
| Controlador Controller Régulateur | Digital IP65 | | | | |
| Material Material [EXT/INT] Matériel | Inox AISI 304 | | | | |
| Espesor Thickness Épaisseur | 40kg/m ³ / Free CFC's / Zero ODP-GWP | | | | |
| Aislamiento Isolation Isolation | 55 | | | | |
| Capacidad Capacity Capacité | 355 | | | | |
| Puertas Doors Portes | 3 | | | | |
| Nº parrillas / Guías Nº shelves / Slides Nº de grilles / Glissière | 3/9 [325x530] | | | | |
| Sistema de frío Cooling System Système de froid | Ventilado / Forced air / Ventilé | | | | |
| Desescarche Defrost Dégivrage | Parada compresor / Compressor off / Arrêt du compresseur | | | | |
| Expansión Expansion Expansion | Capilar / Capillary / Capillaire | | | | |
| Potencia Power Puissance | 368 | | | | |
| Potencia frig. Cooling capacity Puissance Frig. | 690 | | | | |
| Consumo Consumption Consommation | - | | | | |
| Clase energética Energy class Classe Énerg. | - | | | | |
| Refrigerante Refrigerant Gaz | R-290 | | | | |
| Opcional Optional Options | Juego de guías / Slides / Jeu de Glissières [GUIACO115530; GUIACO215530] 38 € | | Parrilla / Wire shelf / Grille [502X12] 44 € | | |
| | Kit 2 cajones 1x1/2 + 1x1/3 [Modelo II] / Drawers kit 1x1/2 + 1x1/3 [Model II] 626 € | | Cerradura / Lock / Serrure [506X120; 506X121] 44 € | | |
| | Kit tiroirs 1x1/2 + 1x1/3 [Modèle II] [JCAJ17ME1/2] 112 € | | | | |
| | Puerta de cristal / Glass door / Porte vitrée [PUE17IDME10-PUE17IIME10] 680 € | | | | |
| | [501X11] = 9 [501X10] = 6 680 € | [501X16] = 8 407 € | - | [501X11] = 2 [501X10] = 4 257 € | [501X11] = 9 [501X10] = 6 680 € |

Serie / Series / Série **GN1/1 700**

+Info: www.infrico.com



[501X11] = 9 [501X10] = 6

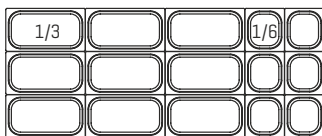

ME 1003 BAN

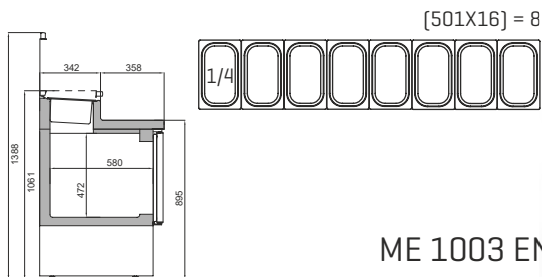

[501X16] = 8

ME 1003 EN



Kit 2 cajones 1x1/2 + 1x1/3 [Modelo II] /
 Drawers kit 1x1/2 + 1x1/3 [Model II]
 Kit tiroirs 1x1/2 + 1x1/3 [Modèle II]
 [JCAJ17ME1/2]

1000 II

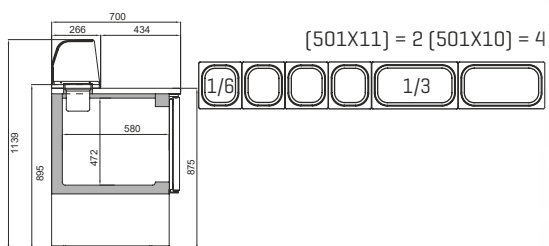

[501X11] = 2 [501X10] = 4

ME 1003 PIZZA





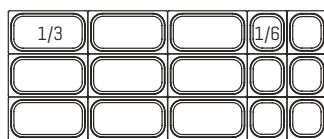

[501X11] = 9 [501X10] = 6

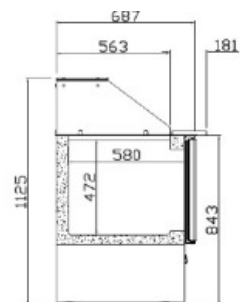

ME 1003 KB



Mesa refrigerada cocktails / Cocktails refrigerator table / Desserte gastronomique positive préparation cocktails

| MODELO MODELE MODÈLE |  |  |  |  |  |
|---|--|---|--|---|--|
| | BST 1600 R | BST 2000 R | BST 1200 N | BST 1600 N | BST 2000 N |
| Precio Price Prix | 5.591 € | 6.981 € | 1.939 € | 2.319 € | 3.243 € |
| Medidas Measures [mm] Mesures | 1600 x 700 x 1059 mm. | 2000 x 700 x 1059 mm. | 1200 x 600 x 944 mm. | 1600 x 600 x 944 mm. | 2000 x 600 x 944 mm. |
| Temperatura Temperature Température | -2°C/+8°C. | | - | | |
| Clase Climática Climatic class Classe climatique | 4 / 38°C | | - | | |
| Tensión/Frecuencia Electrical data Tension électrique | 230V/1ph/50Hz | | - | | |
| Controlador Controller Régulateur | Digital IP65 | | - | | |
| Material Material [EXT/INT] Matériel | Inox AISI 304 | | | | |
| Aislamiento Isolation Isolation | 40kg/m ³ / Free CFC's / Zero ODP-GWP | | | | |
| Cuba para hielo Ice tank Bac à glace | Inyectada y refrigerada Injected and refrigerated Injecté et réfrigéré | | Inyectada / Injected / Injecté | | |
| Capacidad Snack Capacity Snack Capacité Snack [L] | 255 | 310 | - | - | - |
| Cajones Drawers Tiroirs | 4 | 6 | - | - | - |
| Enchufe accesorios Accessories Plug Prise pour accessoires | Sí / Yes / Oui | | - | | |
| Sistema de frío Cooling System Système de froid | Ventilado / Forced air / Ventilé | | - | | |
| Desescarche Defrost Dégivrage | Parada compresor / Compressor off / Arrêt du compresseur | | - | | |
| Expansión Expansion Expansion | Capilar / Capillary / Capillaire | | - | | |
| Potencia Power Puissance [W] | 210 | 368 | - | | |
| Potencia frig. Cooling capacity Puissance Frig. [W A -10°C] | 370 | 690 | - | | |
| Consumo Consumption Consommation [kWh/ 24h] | 1.61 | 1.77 | - | | |
| Clase energética Energy class Classe Énerg. | - | | | | |
| Refrigerante Refrigerant Gaz | R-290 | | - | | |
| Opcional Optional Options | Cerradura / Lock / Serrure (506X209; 506X210) 44 € Puerta (unidad) / Door (unit) / Porte (unité) (PUE17ISN) -242 € Ruedas / Casters / Roulettes 169 € Cubetas 1/9 / Bacs 1/9 / Cuves 1/9 212 € Doble carril de botellas / Double speed rack / Double rail à bouteilles 182 € | | Ruedas / Casters / Roulettes Consultar/To Consult/ Consulter Cubetas 1/9 / Bacs 1/9 / Cuves 1/9 142 € Doble carril de botellas / Double bottle lane / Double rail à bouteilles 182 € | | Ruedas / Casters / Roulettes Consultar/To Consult/ Consulter Cubetas 1/9 / Bacs 1/9 / Cuves 1/9 212 € Doble carril de botellas / Double bottle lane / Double rail à bouteilles 182 € |
| | Sin incremento / No increase / Sans supplément | | | | |

Serie / Series / Série **BAR STATION**

+Info: www.infrico.com

Contenedor para hielo
Ice tray
Bac à glaçons

Tabla de corte
Cutting board
Table à découper

Carril para botellas
Speed rack
Rail à bouteilles

Opcional
Optional
Option

Difusor de agua
Water spreader
Difuseur de l'eau



Mesa refrigeración y congelación Euronorma 600x400 pastelería / Euronorm 600x400 refrigerator and freezer counter / Tour pâtissier positif et négatif Euronorme 600x400

EURONORM 600x400

MODELO
MODELE
MODÈLE



MR 1620

MR 2190

MR 2750

MR 1620 BT

MR 2190 BT

| Precio Price Prix | 2.956 € | 3.524 € | 4.263 € | 3.688 € | 4.311 € |
|--|---|----------------------------|--|---|----------------------------|
| Medidas Measures [mm] Mesures | 1618 x 800 x 850 mm. | 2185 x 800 x 850 mm. | 2752 x 800 x 850 mm. | 1618 x 800 x 850 mm. | 2185 x 800 x 850 mm. |
| Temperatura Temperature Température | -2°C/+8°C | | | -18°C | |
| Clase Climática Climatic class Classe climatique | 5 / 40°C | | | 4 / 38°C | |
| Tensión/Frecuencia Electrical data Tension électrique | 230V/1ph/50Hz | | | | |
| Controlador Controller Régulateur | Digital IP65 | | | | |
| Material Material [EXT/INT] Matériel | Inox AISI 304 | | | | |
| Espesor Thickness Épaisseur | 70 | | | | |
| Aislamiento Isolation Isolation | 40kg/m ³ / Free CFC's / Zero ODP-GWP | | | | |
| Capacidad Capacity Capacité | 420 | 635 | 850 | 420 | 635 |
| Puertas Doors Portes | 2 | 3 | 4 | 2 | 3 |
| Nº parrillas / Guías Nº shelves / Slides Nº de grilles / Glissière | 2/10 [600x400] | 3/15 [600x400] | 4/20 [600x400] | 2/10 [600x400] | 3/15 [600x400] |
| Sistema de frío Cooling System Système de froid | Monoblock ventilado / Forced air monoblock / Monoblock ventilé | | | | |
| Desescarche Defrost Dégivrage | Parada compresor / Compressor off / Arrêt du compresseur | | | Gas caliente / Hot gas defrost / Gaz chaud | |
| Expansión Expansion Expansion | Capilar / Capillary / Capillaire | | | Válvula de expansión termostática / Thermostatic expansion valve / Détendeur thermostatique | |
| Potencia Power Puissance | | 368 | | 568 | 712 |
| Potencia frig. Cooling capacity Puissance Frig. | | 690 | | 540 | 639 |
| Consumo Consumption Consommation | 1,67 | 2,07 | 3,06 | 6,03 | 11,15 |
| Clase energética Energy class Classe Énerg. | A | | B | C | D |
| Refrigerante Refrigerant Gaz | R-290 | | | | |
| Opcional Optional Options | Granito / Granite-top / Granit MR1620 [1618X800X30] [606X35] 684 € | | Parrilla / Wire shelf / Grille [502X26] 50 € | | |
| | Granito / Granite-top / Granit MR2190 [2185X800X30] [606X36] 909 € | | Juego de guías / Slides / Jeu de Glissières [GUAL0120641, GUAL0220641] 44 € | | |
| | Granito / Granite-top / Granit MR2750 [2752X800X30] [606X37] 1.158 € | | Ruedas / Casters / Roulettes [705X16=2; 705X17=2] 169 € | | |
| | Bandeja Inox/ Stainless Steel Tray / Bac Inox 600x400 [A850P41] 51 € | | | | |
| | Cerradura / Lock / Serrure [506X209; 506X210] 44 € | | | | |
| | 115V/1ph/60Hz Sin incremento / No increase / Sans supplément | | | 115V/1ph/60Hz + 3% | |
| | 230V/1ph/60Hz Sin incremento / No increase / Sans supplément | | | 230V/1ph/60Hz Sin incremento / No increase / Sans supplément | |

Serie / Series / Série **800**

+Info: www.infrico.com

MR 2750



MR 2190 BT

Opcional
Optional
Option



Controlador digital IP 65.
Digital control IP65
Contrôleur digital IP 65.

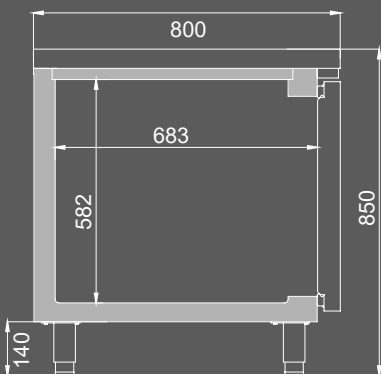

Frío Ventilado con efecto estático para pastelería profesional
Ventilated cooling with static effect for professional patisseries
Refroidissement ventilé avec effet statique pour les pâtisseries professionnelles





Opcional: Manejo control digital por WiFi o Bluetooth
Optional: Operating digital control by WiFi or Bluetooth







Opcional granito
Optional granite worktop
Option granite



Mesa refrigeración 600x400 puerta cristal / 600x400 glass door counter refrigerator / Tour pâtissier positif 600x400 porte vitrée

Mesa refrigeración 600x400 remota / 600x400 remote counter refrigerator / Tour pâtissier positif 600x400 groupe à distance

Grupo remoto / Remote / Groupe à distance

| MODELO MODELE MODÈLE |  |  |  |  |  |  | |
|--|--|---|---|--|---|---|--|
| | MR 1620 CR | MR 2190 CR | MR 2750 CR | MR 1620 GR | MR 2190 GR | MR 2750 GR | |
| Precio Price Prix | 3.420 € | 4.200 € | 5.184 € | 2.204 € | 2.784 € | 3.375 € | |
| Medidas Measures [mm] Mesures | 1618 x 800 x 850 mm. | 2185 x 800 x 850 mm. | 2752 x 800 x 850 mm. | 1390 x 800 x 850 mm. | 1957 x 800 x 850 mm. | 2524 x 800 x 850 mm. | |
| Temperatura Temperature Température | +2°C/+6°C. | | | -2°C/+8°C. | | | |
| Clase Climática Climatic class Classe climatique | 4 / 38°C. | | | 5 / 40°C. | | | |
| Tensión/Frecuencia Electrical data Tension électrique | 230V/1ph/50Hz | | | | | | |
| Controlador Controller Régulateur | Digital IP65 | | | | | | |
| Material Material [EXT/INT] Matériel | Inox AISI 304 | | | | | | |
| Espesor Thickness Épaisseur | 70 | | | | | | |
| Aislamiento Isolation Isolation | 40kg/m ³ / Free CFC's / Zero ODP-GWP | | | | | | |
| Capacidad Capacity Capacité | 420 | 635 | 850 | 420 | 635 | 850 | |
| Puertas Doors Portes | 2 | 3 | 4 | 2 | 3 | 4 | |
| Nº parrillas / Guías N° shelves / Slides N° de grilles / Glissière | 2/10 (600x400) | 3/15 (600x400) | 4/20 (600x400) | 2/10 (600x400) | 3/15 (600x400) | 4/20 (600x400) | |
| Sistema de frío Cooling System Système de froid | Monoblock ventilado / Forced air monoblock / Monoblock ventilé | | | - | | | |
| Desescarche Defrost Dégivrage | Parada compresor / Compressor off / Arrêt du compresseur | | | | | | |
| Expansión Expansion Expansion | Capilar / Capillary / Capillaire | | | Válvula expansión opcional [especificar refrig.] Expansion valve optional [specify refrigerant] Détendeur options [spécifier le gaz] | | | |
| Potencia Power Puissance | 378 | 383 | 389 | 368 | | | |
| Potencia frig. Cooling capacity Puissance Frig. | 690 | | | Recom. 690 | | | |
| Consumo Consumption Consommation | - | | | - | | | |
| Clase energética Energy class Classe Énerg. | - | | | - | | | |
| Refrigerante Refrigerant Gaz | R-290 | | | - | | | |
| Opcional Optional Options | Juego de guías / Slides / Jeu de Glissières [GUIALO120641, GUIALO220641] 44 € | | | | | | |
| | Parrilla doble tupida / Extradense wire shelf / Grille renforcée [502X64] | 58 € | | | Parrilla / Wire shelf / Grille [502X26] | 50 € | |
| | Granito / Granite-top / Granit MR1620 [1618X800X30] [606X35] | 684 € | | | Puerta de cristal / Glass door / Porte vitrée [PUE17IDMR-PUE17IIMR] | 127 € | |
| | Granito / Granite-top / Granit MR2190 [2185X800X30] [606X36] | 909 € | | | Cerradura / Lock / Serrure [506X209; 506X210] | 51 € | |
| | Granito / Granite-top / Granit MR2750 [2752X800X30] [606X37] | 1.158 € | | | Bandeja Inox/ Stainless Steel Tray / Bac Inox 600x400 [A850P41] | 51 € | |
| | Cerradura / Lock / Serrure [506X60] | 61 € | | | Válvula expansión opcional [especificar refrig.] | Expansion valve optional [specify refrigerant] | |
| | Parrilla Inox / Stainless steel wire shelf / Grille inox [502X47] | 84 € | | | Détendeur options [spécifier le gaz] | | |
| | Bandeja Inox/ Stainless Steel Tray / Bac Inox 600x400 [A850P41] | 51 € | | | | | |
| Iluminación Led RGB con cambio de color [por puerta] / Led lighting RGB change of colour [per door] / LED RGB avec changement de couleur [par porte] | 67 € | | | | | | |

Serie / Series / Série **800**

+Info: www.infrico.com



Posibilidad de acceso frontal y lateral para una mejor manipulación
 Front and lateral access for better handling
 Possibilité d'accès frontal et latéral pour une meilleure manipulation.

Aumentan en su largo 8 cm. para una mejor manipulación.
 They increase in their length 8 cm. for better handling.
 8 cm. de long en plus pour une meilleure manipulation.



MR 2190 GR

Doble cristal templado bajo emisivo más carga Argón 4-27-4
 Double tempered glass low-e + Argón 4-27-4
 Double vitrage trempé à faible émissivité avec Argón 4-27-4



Opcional granito
 Optional granite worktop
 Option granite

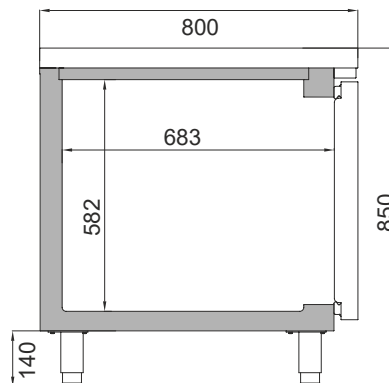

Mesa refrigerada central 600x400 puerta dos caras / 600x400 pass thru counter refrigerator / Tour pâtissier positif 600x400 traversante

Mesa refrigerada 600x400 para ensaladas, pizza y pastelería / 600x400 salads, pizza and pastry prep counter refrigerator / Table positive 600x400 préparation salades, pizzas et pâtisseries

| MODELO MODELE MODÈLE | EURONORM 600x400 Pasante/Pass-thru/Traversante | | | | EURONORM 600x400 Ensalada, pizza y pastelería Salads, pizza & pastry Salade, pizza et pâtisserie | |
|---|--|----------------------------|----------------------------|-------------------------------|--|---------------------------------|
| | MR 1620 PDC | MR 2190 PDC | MR 1620 PDCR | MR 2190 PDCR | MR 1620 EN | MR 2190 EN |
| Precio Price Prix | 3.287 € | 4.019 € | 4.064 € | 5.167 € | 3.891 € | 4.490 € |
| Medidas Measures [mm] Mesures | 1618 x 800 x 850 mm. | 2185 x 800 x 850 mm. | 1618 x 800 x 850 mm. | 2185 x 800 x 850 mm. | 1618 x 800 x 850/1050 mm. | 2185 x 800 x 850/1050 mm. |
| Temperatura Temperature Température | -2°C/+8°C | | +2°C/+6°C | | 0°C/+6°C | |
| Clase Climática Climatic class Classe climatique | 5 / 40°C | | 4 / 38°C | | 4 / 38°C | |
| Tensión/Frecuencia Electrical data Tension électrique | 230V/1ph/50Hz | | | | | |
| Controlador Controller Régulateur | Digital IP65 | | | | | |
| Material Material [EXT/INT] Matériel | Inox AISI 304 | | | | | |
| Espesor Thickness Épaisseur | 70 | | | | | |
| Aislamiento Isolation Isolation | 40kg/m ³ / Free CFC's / Zero ODP-GWP | | | | | |
| Capacidad Capacity Capacité | 420 | 635 | 420 | 635 | 420+55 | 635+80 |
| Puertas Doors Portes | 4 | 6 | 4 | 6 | 2 | 3 |
| Nº parrillas / Guías Nº shelves / Slides Nº de grilles / Glissières | 2/10 (600x400) | 3/15 (600x400) | 2/10 (600x400) | 3/15 (600x400) | 2/10 (600x400) | 3/15 (600x400) |
| Sistema de frío Cooling System Système de froid | Monoblock ventilado / Forced air monoblock / Monoblock ventilé | | | | | |
| Desescarche Defrost Dégivrage | Parada compresor / Compressor off / Arrêt du compresseur | | | | | |
| Expansión Expansion Expansion | Capilar / Capillary / Capillaire | | | | | |
| Potencia Power Puissance | 368 | | 387 | 398 | 368 | |
| Potencia frig. Cooling capacity Puissance Frig. | 690 | | | | | |
| Consumo Consumption Consommation | 1,67 | 2,07 | - | | | |
| Clase energética Energy class Classe Énerg. | A | | A | | - | |
| Refrigerante Refrigerant Gaz | R-290 | | | | | |
| Opcional Optional Options | Parrilla / Wire shelf / Grille [502X26] 48 € Bandeja Inox/ Stainless Steel Tray / Bac Inox 600x400 [A850P41] 49 € Juego de guías / Slides / Jeu de Glissières [GUIALO120641, GUIALO220641] 44 € | | | | | |
| | Parrilla doble tupida / Extradense wire shelf / Grille renforcée [502X64] 58 € Granito / Granite-top / Granit MR1620 [1618X800X30] [606X35] 684 € Granito / Granite-top / Granit MR2190 [2185X800X30] [606X36] 909 € Cerradura / Lock / Serrure [506X60] [PDCR] 61 € Parrilla Inox / Stainless steel wire shelf / Grille inox [502X47] 84 € | | | | Cerradura / Lock / Serrure [506X209; 506X210] 42 € Parrilla de trabajo / Garnish rack / Grille travail [PTMP] 147 € Ruedas / Casters / Roulettes [705X16=2; 705X17=2] 169 € | |
| | [501X16] = 9 445 € | | | [501X16] = 13 662 € | | |

Serie / Series / Série 800

+Info: www.infrico.com

Opcional
Optional
Option

Pasante/Pass-thru/Traversante
MR 2190 PDC

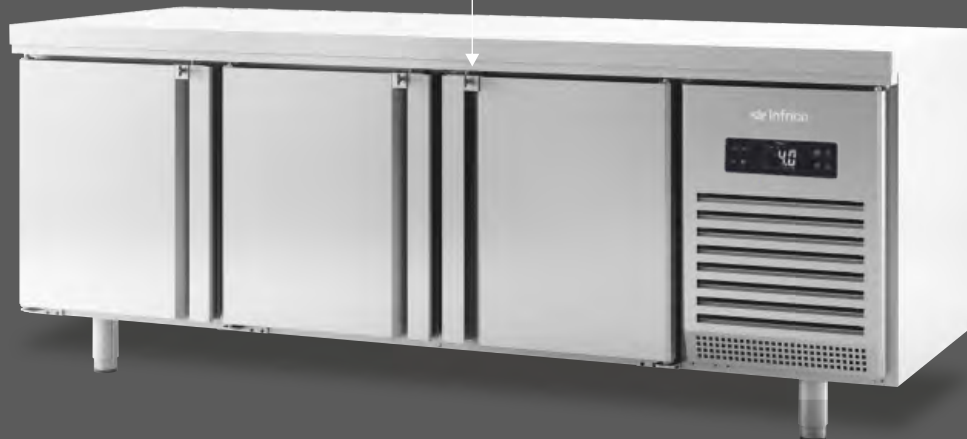

Pasante/Pass-thru/Traversante
MR PDC

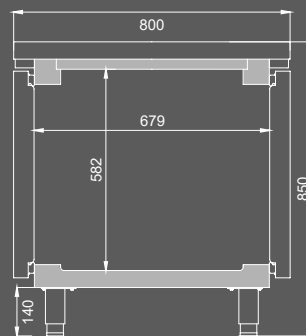

[501X16] = 9



[501X16] = 13

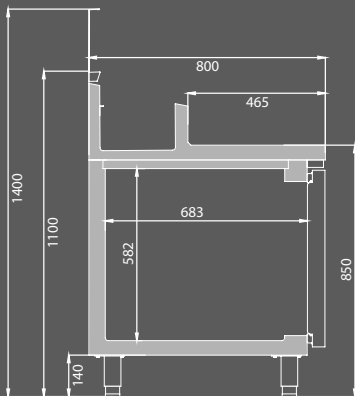

MR 1620 EN

Refrigeración estática en la cuba
Static cooling in the tank
Refroidissement statique



Mesa refrigerada ventilada con control de humedad / Ventilated refrigerated table with humidity control / Table réfrigérée ventilée avec contrôle de l'humidité

MODELO
MODELE
MODÈLE



MR 1620 H



MR 2190 H

| | MR 1620 H | MR 2190 H |
|---|--|---|
| Precio Price Prix | 3.522 € | 4.145 € |
| Medidas Measures [mm] Mesures | 1618 x 800 x 850 mm. | 2185 x 800 x 850 mm. |
| Temperatura Temperature Température | +2°C/+8°C | |
| Clase Climática Climatic class Classe climatique | Humedad / humidity / humidité 45% HR / 85% HR | |
| Tensión/Frecuencia Electrical data Tension électrique | 230V/1ph/50Hz | |
| Controlador Controller Régulateur | Digital IP65 con control de humedad / Digital IP65 with humidity control / Digital IP65 avec contrôle de l'humidité | |
| Material Material [EXT/INT] Matériel | Inox AISI 304 | |
| Espesor Thickness Épaisseur | 70 | |
| Aislamiento Isolation Isolation | 40kg/m ³ / Free CFC's / Zero ODP-GWP | |
| Capacidad Capacity Capacité | 420 | 635 |
| Puertas Doors Portes | 2 | 3 |
| Nº parrillas / Guías Nº shelves / Slides Nº de grilles / Glissière | 2/10 [600x400] | 3/15 [600x400] |
| Sistema de frío Cooling System Système de froid | Monoblock ventilado / Forced air monoblock / Monoblock ventilé | |
| Desescarche Defrost Dégivrage | Parada compresor / Compressor off / Arrêt du compresseur | |
| Expansión Expansion Expansion | Capilar / Capillary / Capillaire | |
| Potencia Power Puissance | 868 | |
| Potencia frig. Cooling capacity Puissance Frig. | 690 | |
| Consumo Consumption Consommation | - | - |
| Clase energética Energy class Classe Énerg. | - | |
| Refrigerante Refrigerant Gaz | R-290 | |
| Opcional Optional Options | Granito / Granite-top / Granit MR1620 [1618X800X30] [606X35] 684 € Granito / Granite-top / Granit MR2190 [2185X800X30] [606X36] 909 € Bandeja Inox/ Stainless Steel Tray / Bac Inox 600x400 [A850P41] 51 € Cerradura / Lock / Serrure [506X209; 506X210] 44 € 115V/1ph/60Hz Sin incremento / No increase / Sans supplément 230V/1ph/60Hz Sin incremento / No increase / Sans supplément | Parrilla / Wire shelf / Grille [502X26] 50 € Juego de guías / Slides / Jeu de Glissières [GUAL0120641, GUAL0220641] 44 € Ruedas / Casters / Roulettes [705X16=2; 705X17=2] 169 € |

Serie / Series / Série **MR H**

+Info: www.infrico.com

Control electrónico de Temperatura y Humedad
Electronic Temperature and Humidity control
Contrôle électronique de la Température et de l'humidité



Opcional granito
Optional granite worktop
Option granite



MR 1620 H



MR 2190 H



Mesa refrigerada pizza Lucena / Pizza prep table Lucena / Table positive et fast food Lucena (MPL)

Mesa refrigerada pizza / Pizza prep table / Table positive pizza (MP)

MODELO
MODELE
MODÈLE



MPL 1740



MPL 2300



MP 1740



MP 2300



MP 1740 CN



MP 2300 CN

| Precio Price Prix | 4.799 € | 5.795 € | 4.739 € | 5.724 € | 4.833 € | 5.875 € | |
|---|--|---|--|--|--|--|--|
| Medidas Measures [mm] Mesures | 1693 x 800 x 850/1010 mm. | 2260 x 800 x 850/1010 mm. | 1738 x 800 x 830/980 mm. | 2305 x 800 x 830/980 mm. | 1738 x 800 x 830/980 mm. | 2305 x 800 x 830/980 mm. | |
| Temperatura Temperature Température | +2°C/+6°C | | | | | | |
| Clase Climática Climatic class Classe climatique | 4 / 38°C | | | 5 / 40°C | | | |
| Tensión/Frecuencia Electrical data Tension électrique | 230V/1ph/50Hz | | | | | | |
| Controlador Controller Régulateur | Digital IP65 | | | | | | |
| Material Material [EXT/INT] Matériel | Inox AISI 304 | | | | | | |
| Espesor Thickness Épaisseur | 55 | | | | | | |
| Aislamiento Isolation Isolation | 40kg/m ³ / Free CFC's / Zero ODP-GWP | | | | | | |
| Capacidad Capacity Capacité | 485 | 700 | 485+48 | 700+70 | [R] 235 [V] 48 [N] 175 | [R] 485 [V] 70 [N] 175 | |
| Puertas Doors Portes | 2 | 3 | 2 | 3 | 1 + Neutro | 2 + Neutro | |
| Nº parrillas / Guías Nº shelves / Slides Nº de grilles / Glissière | 2/10 [600x400] | 3/15 [600x400] | 7 [600x400] | 10 [600x400] | 8 [600x400] | 11 [600x400] | |
| Sistema de frío Cooling System Système de froid | Ventilado / Forced air / Ventilé | | | | | | |
| Desescarche Defrost Dégivrage | Parada compresor / Compressor off / Arrêt du compresseur | | | | | | |
| Expansión Expansion Expansion | Capilar / Capillary / Capillaire | | | | | | |
| Potencia Power Puissance | 368 | | 553 | | 350 | 553 | |
| Potencia frig. Cooling capacity Puissance Frig. | 690 | | 690 | | 370 | 690 | |
| Refrigerante Refrigerant Gaz | R-290 | | | | | | |
| Opcional Optional Options | Parrilla/Wire shelf/Grille [502X26] 50 € | | Parrilla/Wire shelf/Grille [502X26] 50 € | | Parrilla/Wire shelf/Grille [502X26] 50 € | | |
| | Juego de guías/Slides/Jeu de Glissières [GUAL0120641; GUAL0220641] 44 € | | Juego de guías/Slides/Jeu de Glissières [GUAL0120641; GUAL0220641] 44 € | | Juego de guías/Slides/Jeu de Glissières [GUAL0120641; GUAL0220641] 44 € | | |
| Parrilla de trabajo / Garnish rack / Grille travail [PTMT] [MPL1740-3UD] [MPL2300-4UD] 147 € | | Parrilla de trabajo / Garnish rack / Grille travail [PTMT] [MPL1740-3UD] [MPL2300-4UD] 147 € | | Opción neutro 6 cajones / Optional 6 drawers dry store / En option kit 6 tiroirs neutres [JCAJ17MP6] [Solo / Only / Seulement MP2300CN] 693 € | | Opción neutro 6 cajones / Optional 6 drawers dry store / En option kit 6 tiroirs neutres [JCAJ17MP6] [Solo / Only / Seulement MP2300CN] 693 € | |
| Cerradura / Lock / Serrure [506X209; 506X210] 44 € | | Cerradura / Lock / Serrure [506X209; 506X210] 44 € | | Contenedor polipropileno / Polypropylene container / Container polypropylène [501X08] 83 € | | Contenedor polipropileno / Polypropylene container / Container polypropylène [501X08] 83 € | |
| Ruedas / Casters / Roulettes [705X16=2; 705X17=2] 169 € | | Ruedas / Casters / Roulettes [705X16=2; 705X17=2] 169 € | | Cerradura / Lock / Serrure [506X209; 506X210] 44 € | | Cerradura / Lock / Serrure [506X209; 506X210] 44 € | |
| | | | | 115V/1ph/60Hz Sin incremento / No increase / Sans supplément | | 115V/1ph/60Hz Sin incremento / No increase / Sans supplément | |
| | | | | 230V/1ph/60Hz Sin incremento / No increase / Sans supplément | | 230V/1ph/60Hz Sin incremento / No increase / Sans supplément | |
| | | [501X14] = 1 [501X11] = 5 [501X10] = 4 464 € | [501X14] = 1 [501X11] = 8 [501X10] = 4 616 € | [501X13] = 1 [501X16] = 5 299 € | [501X13] = 1 [501X16] = 9 503 € | [501X13] = 1 [501X16] = 5 299 € | [501X13] = 1 [501X16] = 9 503 € |

Serie / Series / Série 800

+Info: www.infrico.com

IMPORTANTE: Las bandejas deben contener producto previamente refrigerado.
IMPORTANT: The trays should contain previously refrigerated product.
IMPORTANT: Les plateaux doivent contenir des produits préalablement réfrigérés.

[501X14] = 1 [501X11] = 8 [501X10] = 4



[501X14] = 1 [501X11] = 5 [501X10] = 4

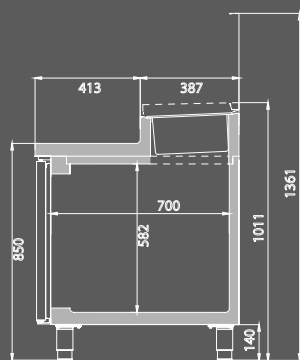

MPL 2300

Parrillas de trabajo
Garnish racks
Grilles de travail



Cajón refrigerado de serie
Refrigerated drawer standard
Tiroir réfrigéré de série

[501X13] = 1 [501X16] = 9



[501X13] = 1 [501X16] = 5



Video del producto

Product Video
Vidéo du produit



Infrico Youtube



Optional: Manejo control digital por WiFi o Bluetooth®
Optional: Operating digital control by WiFi or Bluetooth®

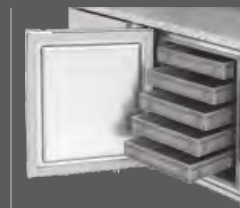

Vitrina de ingredientes incluida
Included ingredients display
De série vitrine avec couvercle vitré

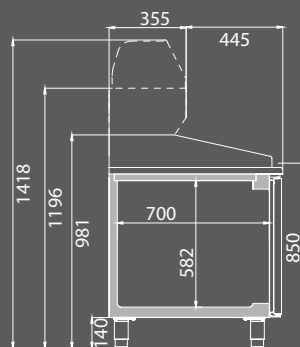

MP 2300 CN

Opcional kit neutro 6 cajones
Optional 6 neutral drawers
En option kit 6 tiroirs neutres



Cajón refrigerado de serie
Refrigerated drawer standard
Tiroir réfrigéré de série

Frente mostrador / Back-bar counter refrigerator / Desserte arrière bar positive cafétéria

Frente mostrador refrigerado preinstalado / Remote back-bar counter refrigerator / Desserte arrière bar groupe à distance cafétéria

MODELO
MODELE
MODÈLE



Preinstalado / Remote / À distance

| | FMPP1500 II | FMPP2000 II | FMPP2500 II | FMPP1500 CR | FMPP2000 CR | FMPP2500 CR | FMPP1500 GR | FMPP2000 GR | FMPP2500 GR |
|---|---|-----------------------------|-----------------------------|-----------------------------|-----------------------------|-----------------------------|---|-----------------------------|-----------------------------|
| Precio Price Prix | 2.634 € | 3.174 € | 3.688 € | 3.141 € | 3.922 € | 4.692 € | 2.027 € | 2.507 € | 2.950 € |
| Medidas Measures [mm] Mesures | 1468 x 600 x 1050 mm. | 1960 x 600 x 1050 mm. | 2452 x 600 x 1050 mm. | 1468 x 600 x 1050 mm. | 1960 x 600 x 1050 mm. | 2452 x 600 x 1050 mm. | 1240 x 600 x 1050 mm. | 1732 x 600 x 1050 mm. | 2224 x 600 x 1050 mm. |
| Temperatura Temperature Température | -2°C/+8°C | | | +2°C/+6°C | | | 0°C/+6°C | | |
| Clase Climática Climatic class Classe climatique | 5 / 40°C | | | 4 / 38°C | | | - | | |
| Tensión/Frecuencia Electrical data Tension électrique | 230V/1ph/50Hz | | | | | | | | |
| Controlador Controller Régulateur | Digital IP65 | | | | | | | | |
| Material Material [EXT/INT] Matériel | Inox AISI 304 | | | | | | | | |
| Espesor Thickness Épaisseur | 70 | | | | | | | | |
| Aislamiento Isolation Isolation | 40kg/m ³ / Free CFC's / Zero ODP-GWP | | | | | | | | |
| Capacidad Capacity Capacité | 340 | 520 | 690 | 340 | 520 | 690 | 340 | 520 | 690 |
| Puertas Doors Portes | 2 | 3 | 4 | 2 | 3 | 4 | 2 | 3 | 4 |
| Nº parrillas / Guías Nº shelves / Slides Nº de grilles / Glissière | 4/4 [325x430] | 6/6 [325x430] | 8/8 [325x430] | 4/4 [325x430] | 6/6 [325x430] | 8/8 [325x430] | 4/4 [325x430] | 6/6 [325x430] | 8/8 [325x430] |
| Sistema de frío Cooling System Système de froid | Monoblock ventilado / Forced air monoblock / Monoblock ventilé | | | | | | - | | |
| Desescarche Defrost Dégivrage | Parada compresor / Compressor off / Arrêt du compresseur | | | | | | | | |
| Expansión Expansion Expansion | Capilar / Capillary / Capillaire | | | | | | Válvula expansión opcional (especificar refrigerante.) Expansion valve optional (specify refrigerant.) Détendeur options (spécifier le gaz) | | |
| Potencia Power Puissance | 209 | 308 | | 377 | 382 | 387 | - | | |
| Potencia frig. Cooling capacity Puissance Frig. | 370 | 690 | | | | Recom. 370 | | Recom. 690 | |
| Consumo Consumption Consommation | 1,55 | 2,06 | 2,35 | - | | | | | |
| Clase energética Energy class Classe Énerg. | A | A | A | - | | | | | |
| Refrigerante Refrigerant Gaz | R-290 | | | | | | | | |
| Opcional Optional Options | Juego de guías / Slides / Jeu de Glissières [GUIAC0115430, GUIAC0215430] 38 € | | | | | | Parrilla / Wire shelf / Grille [502X07] 39€ | | |
| | Parrilla doble tupida / Extradense wire shelf / Grille renforcée [502X43] 49 € | | | | | | Cerradura / Lock / Serrure [506X209; 506X210] 44 € | | |
| | Parrilla inoxidable / Stainless steel wire shelf / Grille Inox [502X49] 67 € | | | | | | Cerradura / Lock / Serrure [506X60] [Mod. CR] 60 € | | |
| | Iluminación Led RGB con cambio de color (por puerta) / Led lighting RGB change of colour (per door) / LED RGB avec changement de couleur (par porte) 67 € | | | | | | | | |
| | Kit cajones / Drawer Kit / Kit tiroirs FM 350 + FM 250 [JCAJ17FM3525] 680 € BM 2 x 1/2x200 + 1 x 1/3x100 [JCAJ17FM1/2] 764 € BM 2/3 x 300 [JCAJ17FM2/3] 680 € | | | - | | | Kit cajones / Drawer Kit / Kit tiroirs FM 350 + FM 250 [JCAJ17FM3525] 680 € BM 2 x 1/2x200 + 1 x 1/3x100 [JCAJ17FM1/2] 764 € BM 2/3 x 300 [JCAJ17FM2/3] 680 € | | |
| | Tolva / Coffe grounds hopper / Tiroir marc à café [TOL17FM] 226 € | | | | | | Válvula expansión opcional (especificar refrigerante.) Expansion valve optional (specify refrigerant.) Détendeur options (spécifier le gaz) | | |
| | Grupo lado contrario / Group opposite side / Groupe opposé [L] 76 € | | | | | | | | |

Serie / Series / Série **600**

+Info: www.infrico.com

FMPP 2000 GR



22cm

Possibilidad de acceso frontal y lateral para una mejor manipulación.

Front and lateral access for better handling.
Possibilité d'accès frontal et latéral pour une meilleur manipulation.

Controlador digital IP 65.
Digital control IP65
Contrôleur digital IP 65.



FMPP 2000 CR



Tolva Opcional
Coffe grounds hopper Optional
Tiroir marc à café Options

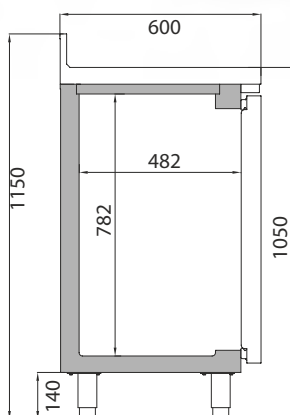

| | | |
|----------------------------------|-------------------------------|-------------------------------|
| FM 250 302 x 418 x 255 | 1/3 302 x 418 x 105 | |
| FM 350 302 x 418 x 352 | 1/2 302 x 418 x 205 | 2/3 302 x 418 x 307 |



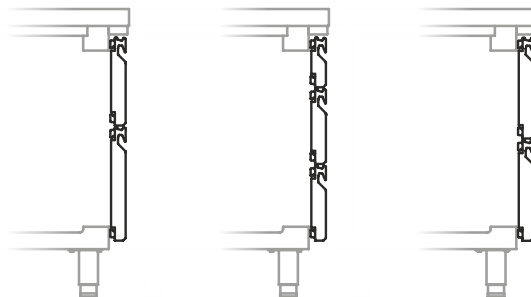



| | | |
|--|--|--|
| Kit 2 cajones 2 drawers kit Kit 2 tiroirs | Kit 3 cajones 3 drawers kit Kit 3 tiroirs | Kit 2 cajones 2 drawers kit Kit 2 tiroirs |
| FM 350 + FM 250 | 2 x BM 1/2 x 200 1 x BM 1/3 x 100 | BM 2 x 2/3 x 300 |



KIT CAJONES / DRAWERS KIT / KIT TIROIRS (MOD. II - GR)

Mueble mesa cafetera / Coffe unit / Meuble caf t ria

Serie / Series / S rie **MCAF**

| MODELO MODELE MOD LE |  |  |  |  |  |  |
|---|---|---|---|--|---|---|
| Precio Price Prix | 812   | 965   | 965   | 1.279   | 1.353   | 1.761   |
| Medidas Measures Mesures [mm] | 820 x 600 x 1050 mm. | 1000 x 600 x 1050 mm. | 1000 x 600 x 1050 mm. | 1468 x 600 x 1050 mm. | 1960 x 600 x 1050 mm. | 2450 x 600 x 1050 mm. |
| Material Material Mat riel [EXT/INT] | Inox AISI 304 | | | | | |
| Opcional Optional Options | Posibilidad de fabricar a medida sin modificar fondo ni cuerpo central. Possibility of custom-made manufacturing without modifying the depth or central body. Possibilit  de fabriquer sur mesure sans modifier ni la profondeur ni la partie centrale. | | | | | |

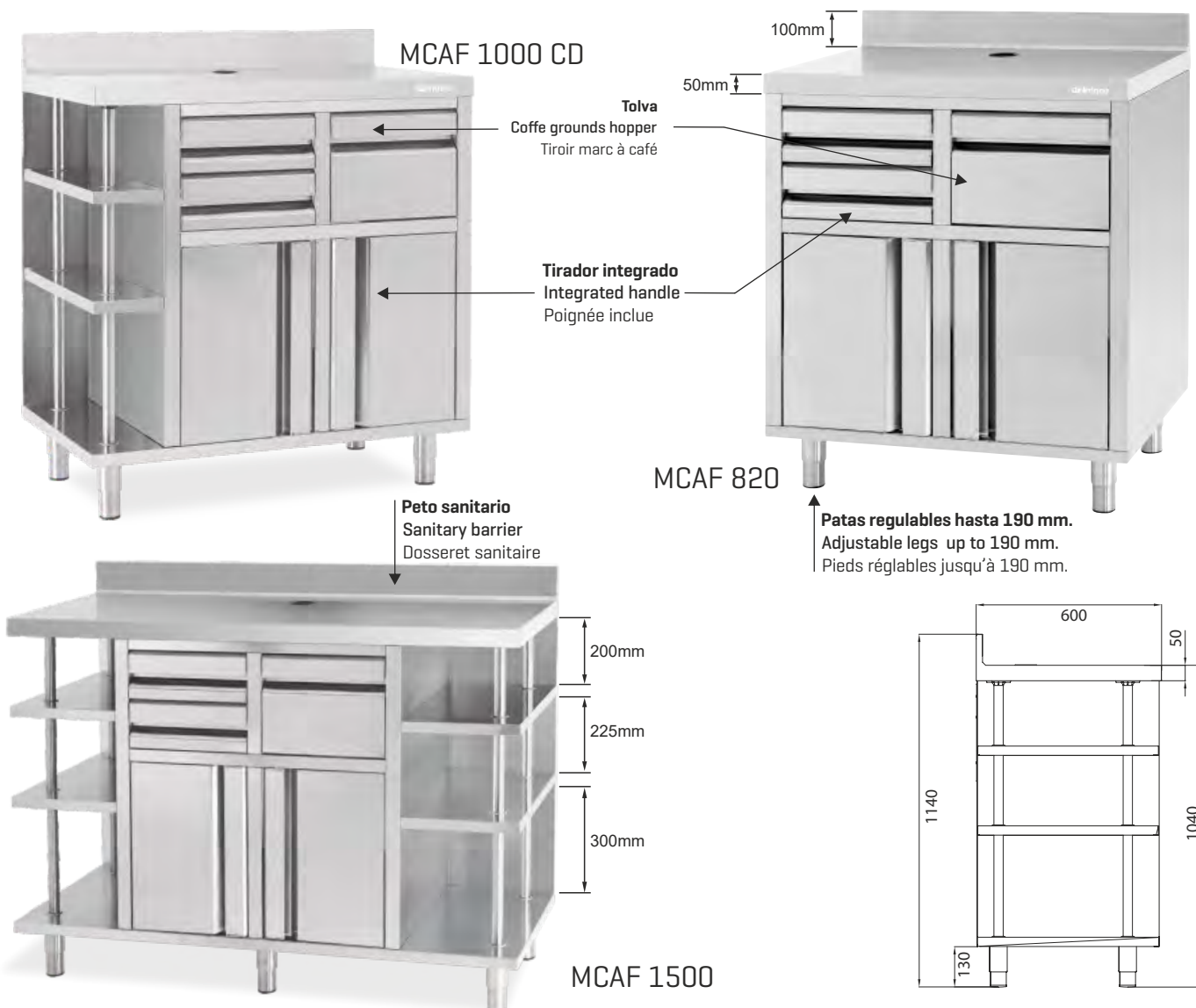





Mueble estantería y mesa de trabajo /
Shelf unit and working table /
Meuble étagère et table de travail

+Info: www.infrico.com

Serie / Series / Série **ME / MT**

MUEBLE ESTANTERÍA / SHELF UNIT / MEUBLE ÉTAGÈRE

| MODELO MODELE MODÈLE |  |  |  |  |  |  |  |  |
|--|---|---|---|---|---|--|---|---|
| | ME 30/1000 | ME 30/1500 | ME 30/2000 | ME 30/2500 | ME 60/1000 | ME 60/1500 | ME 60/2000 | ME 60/2500 |
| Precio Price Prix | 602 € | 793 € | 982 € | 1.419 € | 764 € | 876 € | 1.088 € | 1.596 € |
| Medidas Measures (mm) Mesures | 1000 x 300 x 1050mm. | 1468 x 300 x 1050mm. | 1960 x 300 x 1050mm. | 2452 x 300 x 1050mm. | 1000 x 600 x 1050mm. | 1468 x 600 x 1050mm. | 1960 x 600 x 1050mm. | 2452 x 600 x 1050mm. |
| MESA DE TRABAJO / WORKING TABLE / TABLE DE TRAVAIL | | | | | | | | |
| MODELO MODELE MODÈLE |  |  |  |  |  |  | | |
| | MT 60/1000 | MT 60/1500 | MT 60/2000 | MT 70/1000 | MT 70/1500 | MT 70/2000 | | |
| Precio Price Prix | 614 € | 796 € | 989 € | 693 € | 830 € | 1.068 € | | |
| Medidas Measures (mm) Mesures | 1000 x 600 x 850mm. | 1500 x 600 x 850mm. | 2000 x 600 x 850mm. | 1000 x 700 x 850mm. | 1500 x 700 x 850mm. | 2000 x 700 x 850mm. | | |
| Material Material (EXT/INT) Matériel | Inox AISI 304 | | | | | | | |
| Optional Options | Cajón auxiliar / Additional drawer / Tiroir 600 [CAJMT60] 137 € Cajón auxiliar / Additional drawer / Tiroir 700 [CAJMT70] 147 € Incremento peto mural / Increase for splash blak / Supplément dossieret mod. 1000 54 € Incremento peto mural / Increase for splash blak / Supplément dossieret mod. 1500 79 € Incremento peto mural / Increase for splash blak / Supplément dossieret mod. 2000 96 € | | | | | | | |
| Modelos ME / ME Models / Modèles ME: Medidas especiales consultar con fábrica / Special length measurements consult our factory / Dimensions spéciales en longueur consulter l'usine. | | | | | | | | |

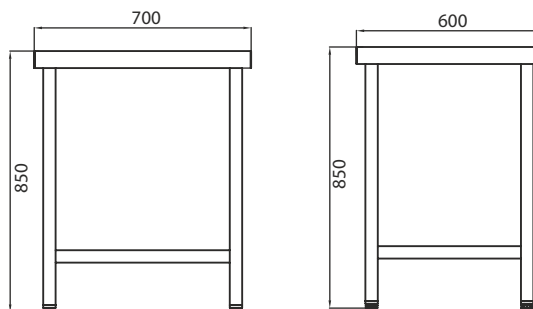
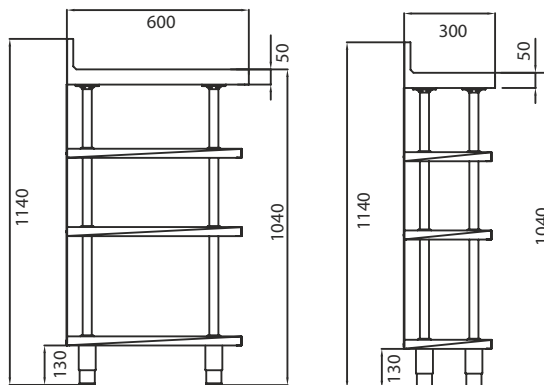

PHOTOBOOK





Armarrios

Reach Ins / Armoires

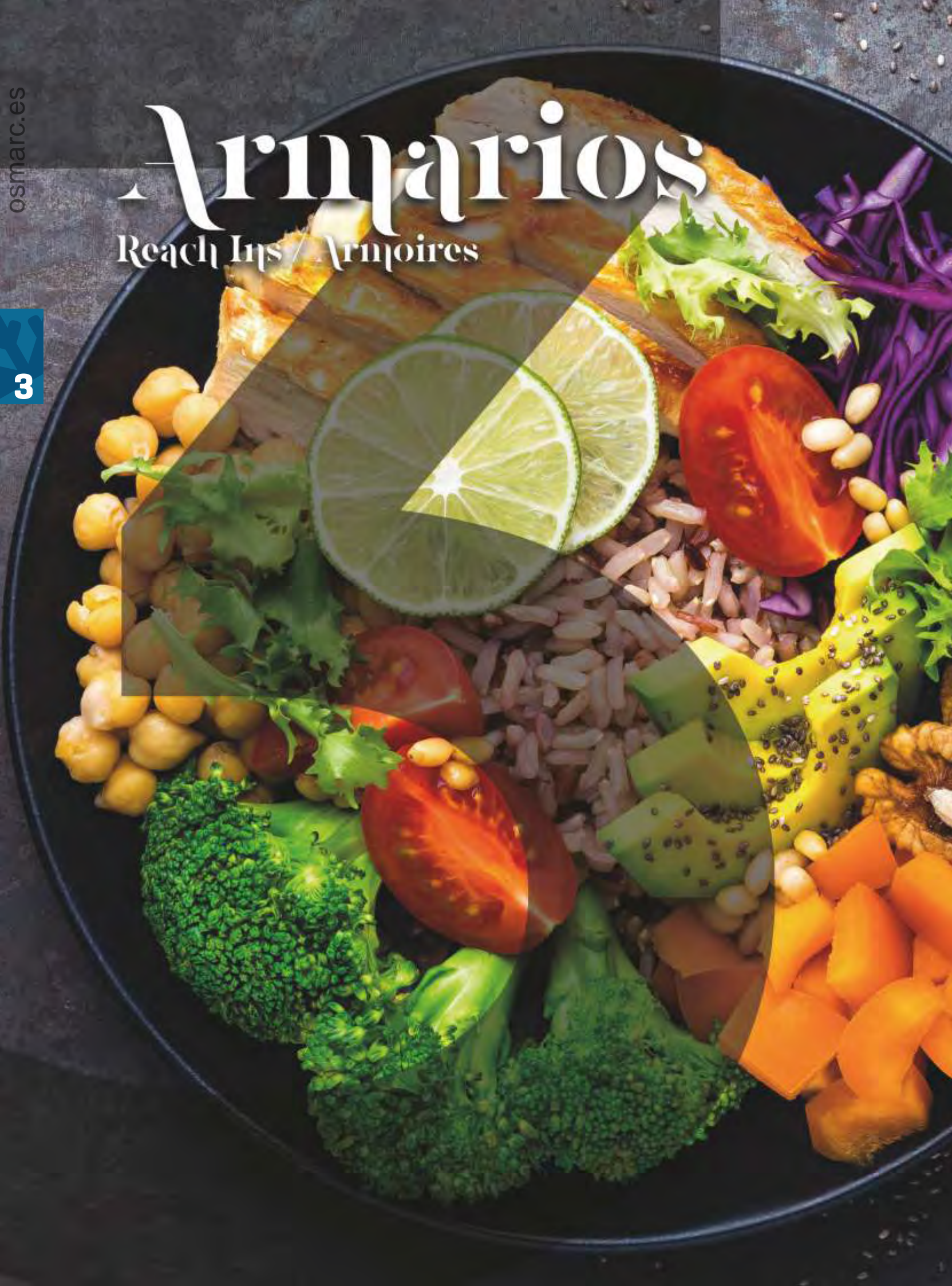



Serie / Series / Série

**NACIONAL
400/900L**

AN T/F
AN BT
AN CR
AP T/F

106-109

Serie / Series / Série

**NACIONAL
500/1000L**

AN T/F
AN BT
AN MX
AN DP TF/G
AN DP TF
AEX T/F
AN BT CR

110-115

Serie / Series / Série

**NACIONAL
1600L**

AN T/F

116-117

Serie / Series / Série

**SLIM LINE
300/600L**

AGN
AGN BT
AGN MX
AGN CR

118-119

Serie / Series / Série

**AGB GN2/1
600/1300L**

AGB
AGB BT

120-121

Serie / Series / Série

**AGB GN2/1
700/1400L**

AGB
AGB BT
AGB MX
AGB CR
AGB CR BT
AGB PESC
AGB A
AGB PAST
AGB BT PAST

122-127

Serie / Series / Série

**EURONORM
60/40-60/80
AGB900L**

AGB
AGB BT

128-129

Serie / Series / Série

**CATERING
AC600L**

AC R
AC BT

128-129

Serie / Series / Série

**PROOFING
FC900BT**

FC BT
FC BT CR

130-131

Serie / Series / Série

**ROLLING
RIC**

RIC
RIC TH

132-133



3. Armarios Reach Ins / Armoires

Controlador digital táctil e intuitivo IP 65.

Digital control easy and intuitive-touch screen IP65 protection.

Contrôleur digital tactile e intuitif IP 65.



Doble acristalamiento templado, bajo emisor con carga de Argón [4-27-4].

Double tempered glass, low-e with argon charge [4-27-4].

Double vitrage et verre trempé [4-27-4].



Iluminación / Lighting / Éclairage

Incorporación de iluminación LED, llegando a reducir el consumo energético entre un 80% y 90%, respecto a una bombilla tradicional. RGB opcional.

LED lighting incorporated, reducing energetic consumption between 80% and 90% respect to a traditional lighth bulb. RGB optional.

Éclairage LED, réduisant la consommation énergétique entre 80% et 90%, par rapport à une ampoule traditionnelle. RGB optionnel.



Monoblock



Puertas con tirador de doble agarre y burlete plano desmontable "cleanless".
 Double handle doors and flat gasket easily removable "cleanless".
 Portes avec double poignée et joint plat facilement démontable "cleanless".



AGB

AGB PAST



Opcional: Manejo del control digital por WiFi o  Bluetooth*

Optional: Operating digital control by WiFi or  Bluetooth*

Optionnel: Fonctionnement de la commande numérique par WiFi ou  Bluetooth*

Opcional: Pata marina

Optional: Marine leg

Optionnel: Pied marin



Armarios de refrigeración y congelación Euronorm 600x400 / Euronorm 600x400 reach in refrigerator and freezer / Armoire Euronorme 600x400 positive et négative

| | REFRIG / REFRIG / POSIT | | | CONGEL / FREEZ / NÉGAT | | REFRIG / REFRIG / POSIT | |
|--|--|-------------------------|-------------------------|---|-------------------------|--|---|
| MODELO MODELE MODÈLE | AN 401 T/F | AN 902 T/F | AN 904 T/F | AN 401 BT | AN 902 BT | AN 401 CR | AN 902 CR |
| Precio Price Prix | 2.357 € | 3.083 € | 3.185 € | 3.290 € | 4.192 € | 2.687 € | 3.514 € |
| Medidas Measures [mm] Mesures | 557 x 775 x 2060 | 1124 x 775 x 2060 | 1124 x 775 x 2060 | 557 x 775 x 2060 | 1124 x 775 x 2060 | 557 x 775 x 2060 | 1124 x 775 x 2060 |
| Temperatura Temperature Température | -2°C/+8°C | | | -18°C | | -2°C/+8°C | |
| Clase Climática Climatic class Classe climatique | 5 / 40°C | | | 4 / 38°C | | 5 / 40°C | |
| Tensión/Frecuencia Electrical data Tension électrique | 230V/1ph/50Hz | | | | | | |
| Controlador Controller Régulateur | Digital IP65 | | | | | | |
| Material Material [EXT/INT] Matériel | AISI 304 | | | | | | |
| Espesor Thickness Épaisseur | 55 | | | | | | |
| Aislamiento Isolation Isolation | 40kg/m ³ / Free CFC's / Zero ODP-GWP | | | | | | |
| Capacidad Capacity Capacité | 395 | 895 | 895 | 395 | 895 | 395 | 895 |
| Puertas Doors Portes | 1 | 2 | 4 | 1 | 2 | 1 | 2 |
| Nº parrillas / Guías Nº shelves / Slides Nº de grilles / Glissière | 3/3 [600x400] | 6/6 [600x400] | | 3/3 [600x400] | 6/6 [600x400] | 3/3 [600x400] | 6/6 [600x400] |
| Sistema de frío Cooling System Système de froid | Forzado / Forced air / Ventilé | | | | | | |
| Desescarche Defrost Dégivrage | Parada de compresor / Compresor off / Arrêt du compresseur | | | Gas caliente / Hot gas / Gaz chaud | | Parada de compresor / Compresor off / Arrêt du compresseur | |
| Expansión Expansion Expansion | Capilar / Capillary / Capillaire | | | Válvula termostática / Expansion valve / Détendeur thermostatique | | Capilar / Capillary / Capillaire | |
| Potencia Power Puissance | 250 | 410 | | 607 | 771 | 250 | 410 |
| Potencia frig. Cooling capacity Puissance Frig. | 370 | 690 | | 540 | 720 | 370 | 690 |
| Consumo Consumption Consommation | 1,55 | 1,90 | | 5,10 | 9,51 | - | - |
| Clase energética Energy class Classe Énerg. | C | B | | D | | - | - |
| Refrigerante Refrigerant Gaz | R-290 | | | | | | |
| Opcional Optional Options | Parrilla / Wire shelf / Grille [502X26] | | | | | | 51 € |
| | Juego de guías / Slides / Jeu de Glissières [GUIAL0120595; GUIAL0220595] | | | | | | 45 € |
| Cerradura / Lock / Serrure [506X209; 506X210] | | | | | | 45 € | |
| Manejo control digital por bluetooth / Operating digital control by bluetooth / Trait. de contrôle digital par bluetooth | | | | | | 151 € | |
| 115V/1ph/60Hz 230V/1ph/60Hz | | | | Sin incremento / No increase / Sans supplément | | 115V/1ph/60Hz 230V/1ph/60Hz | +3% Sin incremento / No increase / Sans supplément |
| | | | | | | 115V/1ph/60Hz 230V/1ph/60Hz | Sin incremento / No increase / Sans supplément |

Serie / Series / Série **NACIONAL 400/900L**

+Info: www.infrico.com

AN 904 T/F



AN 401 CR



AN 401 T/F



AN 902 BT

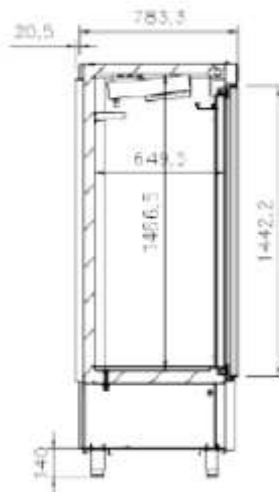

Controlador digital IP 65.
Digital control IP65
Contrôleur digital IP 65.



Armarios de refrigeración y congelación Pastelería y Pescado Euronorm 600x400 / Pastry and Fish Euronorm 600x400 reach in refrigerator and freezer / Armoire Euronorme 600x400 positive et négative pour la Pâtisserie et le Poisson

PASTELERÍA / PASTRY / PÂTISSERIE

PESCADO / FISH / POISSON

MODELO
MODELE
MODÈLE

AN 401 PAST

AN 902 PAST

AN 401 BT PAST

AN 902 BT PAST

AP 401 T/F

AP 902 T/F

| Precio Price Prix | 2.684 € | | 3.804 € | | 3.617 € | | 4.912 € | | 2.925 € | | 4.098 € | | |
|--|--|--|-------------------------|---|---|--|-------------------------|--|--|--------------|-------------------------|-------------|--|
| Medidas Measures [mm] Mesures | 557 x 775 x 2060 | | 1124 x 775 x 2060 | | 557 x 775 x 2060 | | 1124 x 775 x 2060 | | 557 x 775 x 2060 | | 1124 x 775 x 2060 | | |
| Temperatura Temperature Température | -2°C/+8°C | | | | -18°C | | | | -2°C/+2°C | | | | |
| Clase Climática Climatic class Classe climatique | 5 / 40°C | | | | 4 / 38°C | | | | 5 / 40°C | | | | |
| Tensión/Frecuencia Electrical data Tension électrique | 230V/1ph/50Hz | | | | | | | | | | | | |
| Controlador Controller Régulateur | Digital IP65 | | | | | | | | | | | | |
| Material Material [EXT/INT] Matériel | AISI 304 | | | | | | | | | | | | |
| Espesor Thickness Épaisseur | 55 | | | | | | | | | | | | |
| Aislamiento Isolation Isolation | 40kg/m ³ / Free CFC's / Zero ODP-GWP | | | | | | | | | | | | |
| Capacidad Capacity Capacité | 395 | | 895 | | 395 | | 895 | | 395 | | 895 | | |
| Puertas Doors Portes | 1 | | 2 | | 1 | | 2 | | 1 | | 2 | | |
| Nº parrillas / Guías Nº shelves / Slides Nº de grilles / Glissière | 0/18 | | 0/36 | | 0/18 | | 0/36 | | 7 | | 14 | | |
| Sistema de frío Cooling System Système de froid | Forzado / Forced air / Ventilé | | | | | | | | | | | | |
| Desescarche Defrost Dégivrage | Parada de compresor / Compresor off / Arrêt du compresseur | | | | Gas caliente / Hot gas / Gaz chaud | | | | Parada de compresor / Compresor off / Arrêt du compresseur | | | | |
| Expansión Expansion Expansion | Capilar / Capillary / Capillaire | | | | Válvula termostática / Expansion valve / Détendeur thermostatique | | | | Capilar / Capillary / Capillaire | | | | |
| Potencia Power Puissance | 250 | | 410 | | 607 | | 771 | | 250 | | 410 | | |
| Potencia frig. Cooling capacity Puissance Frig. | 370 | | 690 | | 540 | | 720 | | 370 | | 690 | | |
| Consumo Consumption Consommation | 1,55 | | 1,90 | | 5,10 | | 9,51 | | 1,55 | | 1,90 | | |
| Clase energética Energy class Classe Énerg. | C | | B | | D | | | | C | | B | | |
| Refrigerante Refrigerant Gaz | R-290 | | | | | | | | | | | | |
| Opcional Optional Options | Parrilla / Wire shelf / Grille [502X26] | | | | | | | | | | 48 € | | |
| | Juego de guías / Slides / Jeu de Glissières [GUIAL0120595; GUIAL0220595] | | | | | | | | | | 42 € | | |
| | Cerradura / Lock / Serrure [506X209; 506X210] | | | | | | | | | | 42 € | | |
| Manejo control digital por bluetooth / Operating digital control by bluetooth / Trait. de contrôle digital par bluetooth | | | | | | | | | | 143 € | | | |
| Bandeja / Tray / Plateau 600x400 [A850P41] | | | | 49 € | | | | Contenedor polipropileno / Polypropylene container / Container polypropylène [501X08] | | | | 90 € | |
| 115V/1ph/60Hz 230V/1ph/60Hz Sin incremento / No increase / Sans supplément | | | | 115V/1ph/60Hz 230V/1ph/60Hz +3% Sin incremento / No increase / Sans supplément | | | | 115V/1ph/60Hz 230V/1ph/60Hz Sin incremento / No increase / Sans supplément | | | | | |

Serie / Series / Série **NACIONAL 400/900L**
 Serie / Series / Série **AP T/F**

+Info: www.infrico.com

AP 401 T/F



AN 902 PAST



Contenedor polipropileno
 Polypropylene container
 Container polypropylène



600mm x 400mm x 150mm

Bandeja pastelería [opcional]
 Pasty tray [optional]
 Plateau Pâtisserie [optionnel]



AN 400 PAST



Opcional: Manejo control digital por WiFi o Bluetooth®
 Optional: Operating digital control by WiFi or Bluetooth®

Controlador digital IP 65.
 Digital control IP65
 Contrôleur digital IP 65.

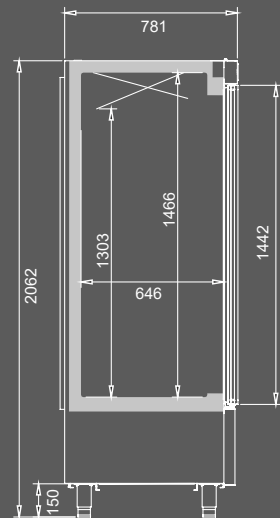

Armarios de refrigeración y congelación / Reach in refrigerator and freezer / Armoire positive et négative

REFRIG / REFRIG / POSIT

CONGEL / FREEZ / NÉGAT

REFRIG-CONGEL / REFRIG-FREEZER / POSIT-NÉGATIVE



MODELO
MODELE
MODÈLE

AN 501 T/F

AN 1002 T/F

AN 501 BT

AN 1002 BT

AN 502 T/F

AN 1003 T/F

AN 1004 T/F

| Precio Price Prix | 2.512 € | 3.421 € | 3.536 € | 4.596 € | 2.569 € | 3.488 € | 3.544 € | |
|--|---|-------------------------|---|--|---|--|-------------------------|---|
| Medidas Measures [mm] Mesures | 687 x 700 x 2060 | 1385 x 700 x 2060 | 687 x 700 x 2060 | 1385 x 700 x 2060 | 687 x 700 x 2060 | 1385 x 700 x 2060 | 1385 x 700 x 2060 | |
| Temperatura Temperature Température | -2°C/+8°C | | -18°C | | -2°C/+8°C | | | |
| Clase Climática Climatic class Classe climatique | 5 / 40°C | | 4 / 38°C | | 5 / 40°C | | | |
| Tensión/Frecuencia Electrical data Tension électrique | 230V/1ph/50Hz | | | | | | | |
| Controlador Controller Régulateur | Digital IP65 | | | | | | | |
| Material Material [EXT/INT] Matériel | AISI 304 | | | | | | | |
| Espesor Thickness Épaisseur | 55 | | | | | | | |
| Aislamiento Isolation Isolation | 40kg/m ³ / Free CFC's / Zero ODP-GWP | | | | | | | |
| Capacidad Capacity Capacité | 500 | 1110 | 500 | 1110 | 500 | 1110 | 1110 | |
| Puertas Doors Portes | 1 | 2 | 1 | 2 | 2 | 3 | 4 | |
| Nº parrillas / Guías Nº shelves / Slides Nº de grilles / Glissière | 3/3 [530x460] | 6/6 [530x510] | 3/3 [530x460] | 6/6 [530x510] | 3/3 [530x460] | 6/6 [530x510] | 6/6 [530x510] | |
| Sistema de frío Cooling System Système de froid | Forzado / Forced air / Ventilé | | | | | | | |
| Desescarche Defrost Dégivrage | Parada de compresor / Compresor off / Arrêt du compresseur | | Gas caliente / Hot gas / Gaz chaud | | Parada de compresor / Compresor off / Arrêt du compresseur | | | |
| Expansión Expansion Expansion | Capilar / Capillary / Capillaire | | | Válv. Expansión/ Expansion valve/ Valve d'expansion | Capilar / Capillary / Capillaire | | | |
| Potencia Power Puissance | 250 | 415 | 610 | 795 | 250 | 420 | | |
| Potencia frig. Cooling capacity Puissance Frig. | 370 | 690 | 540 | 720 | 370 | 690 | | |
| Consumo Consumption Consommation | 1,45 | 2,53 | 5,72 | 10,70 | 1,45 | 2,53 | | |
| Clase energética Energy class Classe Énerg. | C | B | D | | C | B | | |
| Refrigerante Refrigerant Gaz | R-290 | | | | | | | |
| Opcional Optional Options | Parrilla / Wire shelf / Grille AN 500 [502X04] Parrilla / Wire shelf / Grille AN 1000 [502X02] Juego de guías / Slides AN 500 [GUIAC0315470] Juego de guías / Slides GUIAC0115520; GUIAC0215520 Ruedas / Casters / Roulettes [705X16=2; 705X17=2] | | | 52 € 52 € 38 € 38 € 170 € | | Cerradura / Lock / Serrure Manejo control digital wifi/ Operating digital control wifi / Trait. de contrôle digital wifi Barra carnicera / Meat bar set / Barre à viande [BCAN] | | 45 € 151 € 201 € |
| | 115V/1ph/60Hz 230V/1ph/60Hz Sin incremento / No increase / Sans supplément | | 115V/1ph/60Hz 230V/1ph/60Hz +3% Sin incremento / No increase / Sans supplément | | 115V/1ph/60Hz 230V/1ph/60Hz Sin incremento / No increase / Sans supplément | | | |

Serie / Series / Série **NACIONAL 500/1000L**

+Info: www.infrico.com

AN 1003 T/F



AN 501 BT



AN 1002 T/F

Nuevo Controlador digital IP 65.
New Digital control IP65
Contrôleur digital IP 65.



Bisagra reforzada
Reinforced hinge
Charnière renforcée

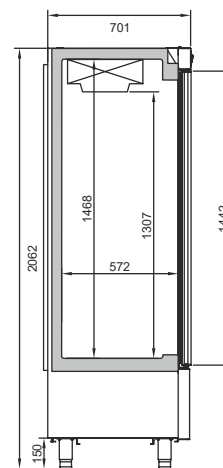
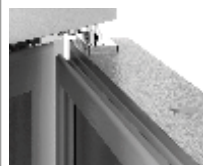

Armarios de refrigeración, congelación y mixtos / Reach in refrigerator, freezer and dual temperature / Armoires positives, négatives et mixtes

CONGELACIÓN / FREEZER / NÉGATIVE

MIXTO / DUAL TEMP / MIXTE

PESCADO / FISH / POISSON

MODELO
MODELE
MODÈLE



AN502 BT

AN1003 BT

AN1004 BT

AN502 MX

AN1002 MX

ANDP1003 TF/G

ANDP1004 TF/G

ANDBT1003 TF

ANDBT1004 TF

| | | | | | | | | | |
|--|--|--|-------------------------|--|---|--|--------------------------------|--|---|
| Precio Price Prix | 3.596 € | 4.670 € | 4.737 € | 4.278 € | 5.546 € | 4.433 € | 4.491 € | 4.716 € | 4.785 € |
| Medidas Measures [mm] Mesures | 687 x 700 x 2060 | 1385 x 700 x 2060 | 1385 x 700 x 2060 | 687 x 700 x 2060 | 1385 x 700 x 2060 | 1385 x 700 x 2060 | 1385 x 700 x 2060 | 1385 x 700 x 2060 | 1385 x 700 x 2060 |
| Temperatura Temperature Température | -18°C | | | -2°C/+8°C -18°C | | -2°C/+8°C -2°C/+2°C | | -2°C/+8°C -18°C | |
| Clase Climática Climatic class Classe climatique | 4 / 38°C | | | | | 5 / 40°C | | 4 / 38°C | |
| Tensión/Frecuencia Electrical data Tension électrique | 230V/1ph/50Hz | | | | | | | | |
| Controlador Controller Régulateur | Digital IP65 | | | | | | | | |
| Material Material [EXT/INT] Matériel | AISI 304 | | | | | | | | |
| Espesor Thickness Épaisseur | 55 | | | | | | | | |
| Aislamiento Isolation Isolation | 40kg/m ³ / Free CFC's / Zero ODP-GWP | | | | | | | | |
| Capacidad Capacity Capacité | 500 | 1110 | | 240/240 | 540/540 | 245/855 | | | |
| Puertas Doors Portes | 2 | 3 | 4 | 2 | | 3 | 4 | 3 | 4 |
| Nº parrillas / Guías Nº shelves / Slides Nº de grilles / Glissière | 3/3 (530x460) | 6/6 (530x510) | 6/6 (530x510) | 3/3 (530x460) | 6/6 (530x510) | 3 Cont. 4 Parr./Shel./Gril. | | 6 Parr./Shel./Gril. | |
| Sistema de frío Cooling System Système de froid | Forzado / Forced air / Ventilé | | | | | | | | |
| Desescarche Defrost Dégivrage | Gas caliente / Hot gas / Gaz chaud | | | Parada comp(+)/Gas caliente(-) Compresor off(+)/Hot gas(-) Arrêt compres(+)/Gaz chaud(-) | | Parada de compresor / Compresor off / Arrêt du compresseur | | Parada comp(+)/Gas caliente(-) Compresor off(+)/Hot gas(-) Arrêt compres(+)/Gaz chaud(-) | |
| Expansión Expansion Expansion | Capilar / Capillary / Capillaire | Válv. Expansión/ Expansion valve/ Détendeur thermostatique | | Capilar / Capillary / Capillaire | | | | | |
| Potencia Power Puissance | 610 | 795 | | 1003 | 1090 | 589 | | 1050 | |
| Potencia frig. Cooling capacity Puissance Frig. | 540 | 720 | | 370 / 445 | 370 / 540 | 690 / 370 | | 690 / 445 | |
| Consumo Consumption Consommation | 5,72 | 10,70 | | 4,84 | 7,91 | - | - | - | - |
| Clase energética Energy class Classe Énerg. | D | | | - | - | - | - | - | - |
| Refrigerante Refrigerant Gaz | R-290 | | | | | | | | |
| Opcional Optional Options | Parrilla / Wire shelf / Grille AN 500 [502X04] | | | 52 € | | Cerradura / Lock / Serrure | | | 45 € |
| | Parrilla / Wire shelf / Grille AN 1000 [502X02] | | | 52 € | | Manejo control digital wifi / Operating digital control wifi / Trait. de contrôle digital wifi | | | |
| | Juego de guías / Slides AN 500 [GUIAC0315470] | | | 38 € | | 151 € | | | |
| | Juego de guías / Slides AN 1000 [GUIAC0115520; GUIAC0215520] | | | 38 € | | Ruedas / Casters / Roulettes [705X16=2; 705X17=2] | | | |
| | Barra carnicera / Meat bar set / Barre à viande [BCAN] | | | 201 € | | 170 € | | | |
| | 115V/1ph/60Hz 230V/1ph/60Hz | | | | +3% Sin incremento / No increase / Sans supplément | | 115V/1ph/60Hz 230V/1ph/60Hz | | Sin incremento / No increase / Sans supplément |
| | | | | | Sin incremento / No increase / Sans supplément | | 115V/1ph/60Hz 230V/1ph/60Hz | | Sin incremento / No increase / Sans supplément |

Serie / Series / Série **NACIONAL 500/1000L**

+Info: www.infrico.com

AN 1003 BT



ANDP 1004 TF/G 

De serie: 3 contenedores de polipropileno en departamento de pescado
 Standard: 3 polypropylene containers in fish department
 Standard : 3 conteneurs en polypropylène au rayon poisson



AN 502 MX

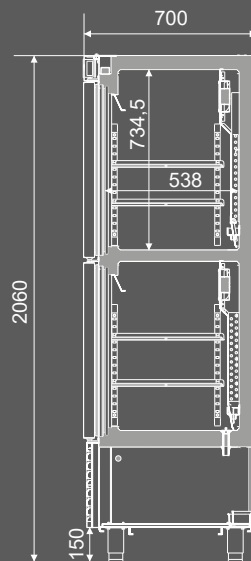

Armarios expositores refrigeración y congelación / Bottom mounted refrigerator and freezer glass door reach in / Armoires positives et négatives portes vitrées

REFRIGERACIÓN / REFRIGERATOR / POSITIVE

CONGELACIÓN / FREEZER / NÉGATIVE

MODELO
MODELE
MODÈLE



AEX500 T/F



AEX1000 T/F



AEX1600 T/F



AN501 BT CR



AN1002 BT CR

| Precio Price Prix | 3.018 € | 4.558 € | 6.338 € | 4.501 € | 6.511 € |
|--|---|-----------------------------|-----------------------------|---|-----------------------------|
| Medidas Measures [mm] Mesures | 687 x 700 x 2060 mm. | 1385 x 700 x 2060 mm. | 2081 x 700 x 2060 mm. | 687 x 700 x 2060 mm. | 1385 x 700 x 2060 mm. |
| Temperatura Temperature Température | +2°C/+6°C | | | -18°C | |
| Clase Climática Climatic class Classe climatique | 4 / 38°C | | | | |
| Tensión/Frecuencia Electrical data Tension électrique | 230V/1ph/50Hz | | | | |
| Controlador Controller Régulateur | Digital IP65 | | | | |
| Material Material [EXT/INT] Matériel | AISI 304 | | | | |
| Espesor Thickness Épaisseur | 55 | | | | |
| Aislamiento Isolation Isolation | 40kg/m ³ / Free CFC's / Zero ODP-GWP | | | | |
| Capacidad Capacity Capacité | 500 | 1110 | 1730 | 500 | 1110 |
| Puertas Doors Portes | 1 | 2 | 3 | 1 | 2 |
| Nº parrillas / Guías Nº shelves / Slides Nº de grilles / Glissière | 4/4 [530x460] | 8/8 [530x510] | 12/12 [530x510] | 4/4 [530x460] | 8/8 [530x510] |
| Consumo Consumption Consommation [kWh/ 24h] | - | - | - | 8,60 | 16,05 |
| Sistema de frío Cooling System Système de froid | Forzado / Forced air / Ventilé | | | | |
| Desescarche Defrost Dégivrage | Parada de compresor / Compresor off / Arrêt du compresseur | | | Gas caliente / Hot gas / Gaz chaud | |
| Expansión Expansion Expansion | Capilar / Capillary / Capillaire | | | Válvula de Expansión Termostática / Thermostatic expansion valve / Valve d'expansion Thermostatique | |
| Potencia Power Puissance [W] | 270 | 455 | 615 | 755 | 1130 |
| Potencia frig. Cooling capacity Puissance Frig. [W A -10°C] | 390 | 690 | 950 | 723 | 1010 |
| Refrigerante Refrigerant Gaz | R-290 | | | | |
| Opcional Optional Options | Juego de guías / Slides AN 500 [GUIAC0315470] | | | 38 € | |
| | Juego de guías / Slides AN 1000 [GUIAC0115520; GUIAC0215520] | | | 38 € | |
| | Parrilla doble tupida / Dense wire shelf / Grilles AN 500 [502X90] | | | 74 € | |
| | Parrilla doble tupida / Dense wire shelf / Grilles AN 1000 [502X89] | | | 77 € | |
| | Cerradura / Lock / Serrure [506X60] | | | 61 € | |
| | Manejo control digital wifi / Operating digital control wifi / Trait. de contrôle digital wifi | | | 151 € | |
| | Iluminación Led RGB con cambio de color [por puerta] / Led lighting RGB change of colour [per door] / LED RGB avec changement de couleur [par porte] | | | 61 € | |
| | 115V/1ph/60Hz 230V/1ph/60Hz Sin incremento / No increase / Sans supplément | | | 115V/1ph/60Hz 230V/1ph/60Hz +3% Sin incremento / No increase / Sans supplément | |

Serie / Series / Série **NACIONAL 500/1000L**

+Info: www.infrico.com

AEX 1000 T/F

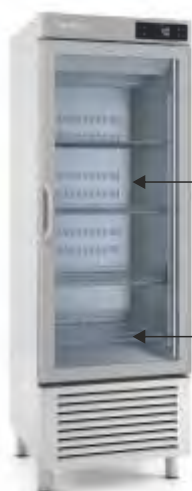

AN 501 BT CR

Triple acristalamiento templado, bajo emisivo con carga de Argón [4-12-3-12-4]
Triple tempered glass, low emission with Argon charge [4-12-3-12-4]
Triple vitrage trempé à faible émissivité avec Argon [4-12-3-12-4]

Parrilla reforzada
Reinforced shelves
Grille renforcée



Nuevo Controlador digital IP 65.
New Digital control IP65
Contrôleur digital IP 65.

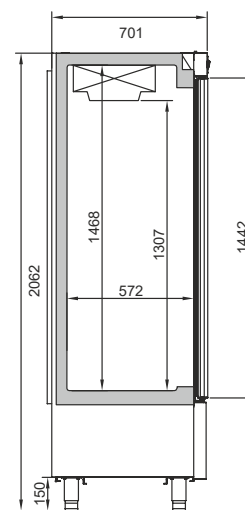

Armario de refrigeración / Bottom mounted refrigerator / Armoire positive

Armario de refrigeración GN1/1 / GN1/1 Reach in refrigerator / Armoire positive GN1/1

Serie / Series / Série **NACIONAL 1600L**Serie / Series / Série **SLIM LINE 300/600L**

MODELO
MODELE
MODÈLE

AN1603 T/F

AN1605 T/F

AN1606 T/F

AGN301

AGN602

| Precio Price Prix | 4.973 € | 5.089 € | 5.135 € | 2.326 € | 3.045 € |
|--|--|-----------------------------|--|---|----------------------------|
| Medidas Measures [mm] Mesures | 2081 x 700 x 2060 mm. | 2081 x 700 x 2060 mm. | 2081 x 700 x 2060 mm. | 482 x 695 x 2100 mm. | 974 x 695 x 2100 mm. |
| Temperatura Temperature Température | -2°C/+8°C | | | -2°C/+8°C | |
| Clase Climática Climatic class Classe climatique | 5 / 40°C | | | 5 / 40°C | |
| Tensión/Frecuencia Electrical data Tension électrique | 230V/1ph/50Hz | | | | |
| Controlador Controller Régulateur | Digital IP65 | | | | |
| Material Material [EXT/INT] Matériel | AISI 304 | | | | |
| Espesor Thickness Épaisseur | 55 | | | | |
| Aislamiento Isolation Isolation | 40kg/m ³ / Free CFC's / Zero ODP-GWP | | | | |
| Capacidad Capacity Capacité | 1730 | | | 325 | 745 |
| Puertas Doors Portes | 3 | 5 | 6 | 1 | 2 |
| Nº parrillas / Guías Nº shelves / Slides Nº de grilles / Glissière | 9/9 (530x510) | | | 3/3 (325x530) | 6 / 6 (325x530) |
| Sistema de frío Cooling System Système de froid | Forzado / Forced air / Ventilé | | | | |
| Desescarche Defrost Dégivrage | Parada de compresor / Compresor off / Arrêt du compresseur | | | | |
| Expansión Expansion Expansion | Capilar / Capillary / Capillaire | | | | |
| Potencia Power Puissance | 420 | | | 237 | 402 |
| Potencia frig. Cooling capacity Puissance Frig. | 690 | | | 370 | 690 |
| Consumo Consumption Consommation | 3,60 | | | 1,40 | 1,85 |
| Clase energética Energy class Classe Énerg. | B | | | C | |
| Refrigerante Refrigerant Gaz | R-290 | | | | |
| Opcional Optional Options | Juego de guías / Slides / Jeu de Glissières (GUIAC0115520; GUIAC0215520) | 38 € | Manejo control digital bluetooth o wifi / Operating digital control bluetooth or wifi / Trait. de contrôle digital bluetooth ou wifi | | |
| | Cerradura / Lock / Serrure (506X209; 506X210) | 45 € | 151 € | | |
| | | | Ruedas/Casters/Roulettes (705X16=2; 705X17=2) | | |
| | Parrilla / Wire shelf / Grille AN 1600 (502X04) | 52 € | | Parrilla / Wire shelf / Grille (502X12) | 46 € |
| | Barra carnícera / Meat bar set / Barre à viande (BCAN) | 201 € | | | |
| | | | 115V/1ph/60Hz 230V/1ph/60Hz Sin incremento / No increase / Sans supplément | | |

Serie / Series / Série **NACIONAL 1600L**
 Serie / Series / Série **SLIM LINE 300/600L**

+Info: www.infrico.com



AN 1606 T/F

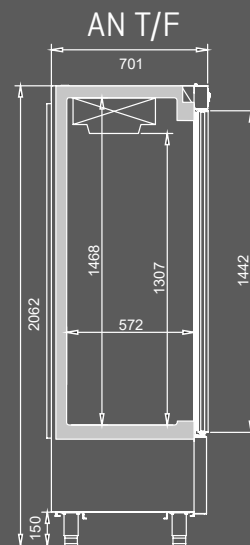

AGN 301



AGN 602

Controlador digital IP 65.
 Digital control IP65
 Contrôleur digital IP 65.



Opcional: Manejo control digital por WiFi o  Bluetooth®
 Optional: Operating digital control by WiFi or  Bluetooth®

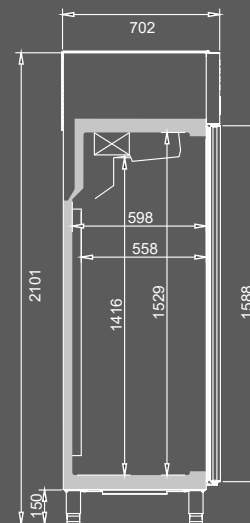

Armarios de refrigeración y congelación GN1/1 / GN1/1 Refrigerator and freezer reach in / Armoires positives et négatives GN1/1

CONGELACIÓN / FREEZER / NÉGATIVE

REFRIGERACIÓN / REFRIGERATOR / POSITIVE

REFRIG/REFRIG/POSIT



MODELO
MODELE
MODÈLE

AGN301 BT

AGN602 BT

AGN602 MX

AGN302

AGN603

AGN604

AGN300 CR

AGN600 CR

| Precio Price Prix | 3.019 € | 4.052 € | 4.741 € | 2.411 € | 3.119 € | 3.190 € | 2.655 € | 3.900 € |
|--|--|---|--|---|---|---|----------------------------|----------------------------|
| Medidas Measures [mm] Mesures | 482 x 695 x 2100 mm. | 974 x 695 x 2100 mm. | 974 x 695 x 2100 mm. | 482 x 695 x 2100 mm. | 974 x 695 x 2100 mm. | 974 x 695 x 2100 mm. | 482 x 695 x 2100 mm. | 974 x 695 x 2100 mm. |
| Temperatura Temperature Température | -18°C | | -2°C/+8°C -18°C | -2°C/+8°C | | | +2°C/+6°C | |
| Clase Climática Climatic class Classe climatique | 4 / 38°C | | | 5 / 40°C | | | 4 / 38°C | |
| Tensión/Frecuencia Electrical data Tension électrique | 230V/1ph/50Hz | | | | | | | |
| Controlador Controller Régulateur | Digital IP65 | | | | | | | |
| Material Material [EXT/INT] Matériel | AISI 304 | | | | | | | |
| Espesor Thickness Épaisseur | 55 | | | | | | | |
| Aislamiento Isolation Isolation | 40kg/m ³ / Free CFC's / Zero ODP-GWP | | | | | | | |
| Capacidad Capacity Capacité | 325 | 745 | 325+325 | 325 | 745 | | 325 | 745 |
| Puertas Doors Portes | 1 | 2 | | 2 | 3 | 4 | 1 | 2 |
| Nº parrillas / Guías Nº shelves / Slides Nº de grilles / Glissière | 3/3 (325x530) | 6/6 (325x530) | | 3/3 (325x530) | 6/6 (325x530) | | 4/4 (325x530) | 8/8 (325x530) |
| Sistema de frío Cooling System Système de froid | Forzado / Forced air / Ventilé | | | | | | | |
| Desescarche Defrost Dégivrage | Gas caliente / Hot gas / Gaz chaud | | Parada comp(+)/Gas caliente(-) Compresor off(+)/Hot gas(-) Arrêt compres(+)/Gaz chaud(-) | Parada de compresor / Compresor off / Arrêt du compresseur | | | | |
| Expansión Expansion Expansion | Válv. Expansión/ Expansion valve/ Détendeur thermostatique | | Capilar(+)/ V. Exp(-) Cap(+)/ Exp. valve(-) Cap(+)/ V. d'exp(-) | Capilar / Capillary / Capillaire | | | | |
| Potencia Power Puissance | 550 | 725 | 772 | 237 | 406 | | 252 | 456 |
| Potencia frig. Cooling capacity Puissance Frig. | 445 | 720 | 370 / 445 | 370 | 690 | | 370 | 690 |
| Consumo Consumption Consommation | 4,83 | 9,22 | - | 1,40 | 1,85 | | - | |
| Clase energética Energy class Classe Energ. | D | | - | C | | | - | |
| Refrigerante Refrigerant Gaz | R-290 | | | | | | | |
| Opcional Optional Options | 230V/1ph/60Hz | Sin incremento / No increase / Sans supplément | | Manejo control digital bluetooth o wifi / Operating digital control bluetooth or wifi / Trait. de contrôle digital bluetooth ou wifi | | Juego de guías / Slides / Jeu de Glissières (GUIACO115550; GUIACO215550) 38 € | | |
| | 115V/1ph/60Hz | +3% | | 115V/1ph/60Hz | | Sin incremento / No increase / Sans supplément | | |
| | Parrilla / Wire shelf / Grille (502X12) | 46 € | | Parrilla inoxidable / Stainless steel wire shelf / Grille Inox (502X46) | | 76 € | | |
| Ruedas / Casters / Roulettes (705X16=2; 705X17=2) | 170 € | | Cerradura / Lock / Serrure (506X209; 506X210) | | 45 € | | | |
| Cerradura / Lock / Serrure (506X209; 506X210) | 45 € | | Parrilla tupida / Extradense wire shelf / Grille renforcée (502X62) | | 53 € | | | |
| | | | Ruedas / Casters / Roulettes (705X16=2; 705X17=2) | | 170 € | | | |
| | | | | | Parrilla tupida / Extradense wire shelf / Grille renforcée (502X62) 53 € | | | |
| | | | | | Cerradura/Lock/Serrure (506X60) 61 € | | | |
| | | | | | Iluminación Led RGB con cambio de color (por puerta) / Led lighting RGB change of colour [per door] / LED RGB avec change- ment de couleur [par porte] 68 € | | | |

Serie / Series / Série **SLIM LINE 300/600L**

+Info: www.infrico.com

AGN 301 BT



AGN 604



AGN 600 CR

Doble acristalamiento templado, bajo emisivo con carga de Argón [4-27-4]
 Double tempered glass, low emission with Argon charge [4-27-4]
 Double vitrage trempé à faible émissivité avec Argon [4-27-4]

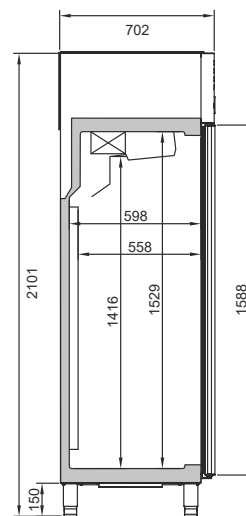

Armarios de refrigeración y congelación GN2/1 / GN2/1 Refrigerator and freezer reach in / Armoires positives et négatives GN2/1



AGB651



AGB1302



AGB651 BT



AGB1302 BT

| MODELO MODELE MODÈLE | AGB651 | AGB1302 | AGB651 BT | AGB1302 BT |
|---|---|---|--|---|
| Precio Price Prix | 2.751 € | 3.608 € | 3.375 € | 4.383 € |
| Medidas Measures [mm] Mesures | 687 x 794 x 1989 mm. | 1385 x 794 x 1989 mm. | 687 x 794 x 1989 mm. | 1385 x 794 x 1989 mm. |
| Temperatura Temperature Température | -2°C/+8°C | | -18°C | |
| Clase Climática Climatic class Classe climatique | 5 / 40°C | | 4 / 38°C | |
| Tensión/Frecuencia Electrical data Tension électrique | 230V/1ph/50Hz | | | |
| Controlador Controller Régulateur | Digital IP65 | | | |
| Material Material [EXT/INT] Matériel | AISI 304 | | | |
| Espesor Thickness Épaisseur | 75 | | | |
| Aislamiento Isolation Isolation | 40kg/m ³ / Free CFC's / Zero ODP-GWP | | | |
| Capacidad Capacity Capacité | 505 | 1120 | 505 | 1120 |
| Puertas Doors Portes | 1 | 2 | 1 | 2 |
| Nº parrillas / Guías Nº shelves / Slides Nº de grilles / Glissière | 3 [530x650] | 6 [530x650] | 3 [530x650] | 6 [530x650] |
| Sistema de frío Cooling System Système de froid | MONOBLOCK Forzado / Forced air / Ventilé | | | |
| Desescarche Defrost Dégivrage | Parada compres./ Compresor off/ Arrêt compres. | | Gas caliente / Hot gas / Gaz chaud | |
| Expansión Expansion Expansion | Capilar/ Capillary / Capillaire | | Válv. Expansión/ Expansion valve/ Détendeur thermostatique | |
| Potencia Power Puissance | 210 | 374 | 664 | 1054 |
| Potencia frig. Cooling capacity [WA -10/-30°C] Puissance Frig. | 370 | 690 | 583 | 1010 |
| Consumo Consumption Consommation | 1,41 | 2,40 | 7,12 | 13,11 |
| Clase energética Energy class Classe Énerg. | C | C | D | D |
| Refrigerante Refrigerant Gaz | R-290 | | | |
| Opcional Optional Options | Manejo control digital bluetooth o wifi / Operating digital control bluetooth or wifi / Trait. de contrôle digital bluetooth ou wifi 151 € Parrilla tupida / Extradense wire shelf / Grille renforcée [502X91] 53 € Ruedas / Casters / Roulettes [705X16=2; 705X17=2] 170 € | | | |
| | 115V/1ph/60Hz | Sin incremento / No increase / Sans supplément | | 115V/1ph/60Hz + 3 % |
| | 230V/1ph/60Hz | Sin incremento / No increase / Sans supplément | | 230V/1ph/60Hz Sin incremento / No increase / Sans supplément |

Serie / Series / Série **AGB 600/1300L**

+Info: www.infrico.com

AGB 1302 BT



Medida para pasar bajo puertas estándar
Measurement to pass under standard doors
Mesure pour passer sous les portes standard

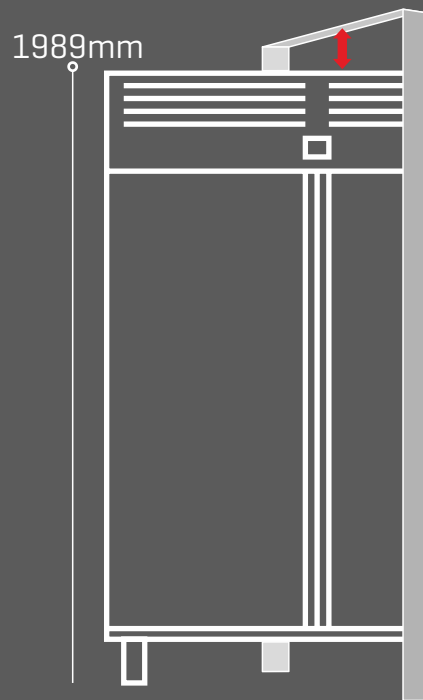

Cerradura de serie
Door lock included
Serrure de série

Costados con guías embutidas
End pannels with embedded rails
Joues avec rails emboutis



Monoblock

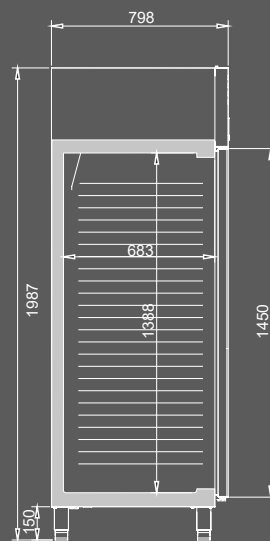

AGB 651

Armarios de refrigeración y congelación GN2/1 / GN2/1 Refrigerator and freezer reach in / Armoires positives et négatives GN2/1

REFRIGERACIÓN-CONGELACIÓN / REFRIGERATOR-FREEZER / POSITIVE-NÉGATIVE

MODELO
MODELE
MODÈLE



AGB701

AGB1402

AGB701 BT

AGB1402 BT

AGB702

AGB702 BT

AGB1403

AGB1404

| Precio Price Prix | 2.796 € | 4.289 € | 3.738 € | 5.312 € | 2.880 € | 3.791 € | 4.346 € | 4.401 € |
|--|---|--|---|---|---|---|---|-----------------------------|
| Medidas Measures [mm] Mesures | 687 x 794 x 2130 mm. | 1385 x 794 x 2130 mm. | 687 x 794 x 2130 mm. | 1385 x 794 x 2130 mm. | 687 x 794 x 2130 mm. | 687 x 794 x 2130 mm. | 1385 x 794 x 2130 mm. | 1385 x 794 x 2130 mm. |
| Temperatura Temperature Température | -2°C/+8°C | | -18°C | | -2°C/+8°C | | -18°C | |
| Clase Climática Climatic class Classe climatique | 5 / 40°C | | 4 / 38°C | | 5 / 40°C | | 4 / 38°C | |
| Tensión/Frecuencia Electrical data Tension électrique | 230V/1ph/50Hz | | | | | | | |
| Controlador Controller Régulateur | Digital IP65 | | | | | | | |
| Material Material [EXT/INT] Matériel | AISI 304 | | | | | | | |
| Espesor Thickness Épaisseur | 75 | | | | | | | |
| Aislamiento Isolation Isolation | 40kg/m ³ / Free CFC's / Zero ODP-GWP | | | | | | | |
| Capacidad Capacity Capacité | 560 | 1240 | 560 | 1240 | 560 | | 1240 | |
| Puertas Doors Portes | 1 | 2 | 1 | 2 | 2 | 3 | 4 | |
| Nº parrillas / Guías Nº shelves / Slides Nº de grilles / Glissière | 3 [530x650] | 6 [530x650] | 3 [530x650] | 6 [530x650] | 3 [530x650] | 6 [530x650] | | |
| Sistema de frío Cooling System Système de froid | MONOBLOCK Forzado / Forced air / Ventilé | | | | | | | |
| Desescarche Defrost Dégivrage | Parada compres./ Compresor off/ Arrêt compres. | | Gas caliente / Hot gas / Gaz chaud | | Parada compres./ Compresor off/ Arrêt compres. | | Gas caliente / Hot gas / Gaz chaud | |
| Expansión Expansion Expansion | Capilar/ Capillary / Capillaire | | Válv. Expansión/ Expansion valve/ Détendeur thermostatique | | Capilar/ Capillary / Capillaire | | Válv. exp. Termostát./ Thermost. exp. valve/ Détendeur thermos. | |
| Potencia Power Puissance | 210 | 374 | 664 | 1054 | 210 | 664 | 371 | |
| Potencia frig. Cooling capacity Puissance Frig. | 370 | 690 | 583 | 1010 | 370 | 583 | 690 | |
| Consumo Consumption Consommation | 1,54 | 2,55 | 7,80 | 13,92 | 1,54 | 7,80 | 2,55 | |
| Clase energética Energy class Classe Énerg. | C | B | D | | C | D | B | |
| Refrigerante Refrigerant Gaz | R-290 | | | | | | | |
| Opcional Optional Options | Parrilla tupida / Extradense wire shelf / Grille renforcée [502X91] 53 € Barra carnicera / Meat bar set / Barre à viande [BCAN] 201 € Ruedas / Casters / Roulettes [705X16=2; 705X17=2] 170 € Manejo control digital bluetooth o wifi/ Operating digital control bluetooth or wifi / Trait. de contrôle digital bluetooth ou wifi 151 € | | | | | | | |
| | 115V/1ph/60Hz 230V/1ph/60Hz Sin incremento / No increase / Sans supplément | 115V/1ph/60Hz + 3% 230V/1ph/60Hz Sin incremento / No increase / Sans supplément | 115V/1ph/60Hz 230V/1ph/60Hz Sin incremento / No increase / Sans supplément | 115V/1ph/60Hz 230V/1ph/60Hz Sin incremento / No increase / Sans supplément | 115V/1ph/60Hz 230V/1ph/60Hz + 3% 230V/1ph/60Hz Sin incremento / No increase / Sans supplément | 115V/1ph/60Hz 230V/1ph/60Hz Sin incremento / No increase / Sans supplément | 115V/1ph/60Hz 230V/1ph/60Hz Sin incremento / No increase / Sans supplément | |

Serie / Series / Série **AGB 700/1400L**

+Info: www.infrico.com

AGB 1404



Nuevo Controlador digital IP 65.
New Digital control IP65
Contrôleur digital IP 65.



AGB 701



AGB 702 BT



Opcional: Manejo control digital por WiFi o Bluetooth®

Optional: Operating digital control by WiFi or Bluetooth®



Monoblock



Costados embutidos
Stamped inner sides
Intérieurs emboutis



Parrillas reforzadas
Reinforced wire shelves
Grilles renforcées

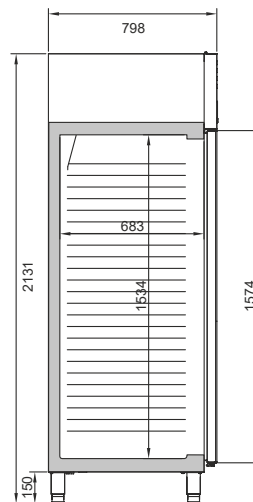

Armarios de refriger. congel. y mixtos GN2/1 / GN2/1 Refrig, freezer and dual temp. reach in / Armoires positives, négatives et mixtes GN2/1

Armarios de refriger. pescado 600x400 / 600x400 Fish refrigerator reach in / Armoire positives 600x400 poisson

MIXTO / DUAL TEMP / MIXTE

REFRIG-CONGEL / REFRIG-FREEZER / POSIT-NÉGATIVE

PESCADO / FISH / POISSON

MODELO
MODELE
MODÈLE



AGN702 MX

AGB1402 MX

AGB701 CR

AGB1402 CR

AGB701 BT CR

AGB1402 BT CR

AGB701 PESC

AGB1402 PESC

| Precio Price Prix | 4.444 € | 6.467 € | 3.202 € | 4.971 € | 4.636 € | 7.188 € | 3.447 € | 5.653 € | |
|--|--|--|----------------------------|---|---|--|--------------------------------------|---------------------------------------|--|
| Medidas Measures [mm] Mesures | 687 x 794 x 2130 mm. | 1385 x 794 x 2130 mm. | 687 x 794 x 2130 mm. | 1385 x 794 x 2130 mm. | 687 x 794 x 2130 mm. | 1385 x 794 x 2130 mm. | 687 x 794 x 2130 mm. | 1385 x 794 x 2130 mm. | |
| Temperatura Temperature Température | -2°C/+8°C -18°C | | -2°C/+6°C | | -18°C | | -2°C/+2°C | | |
| Clase Climática Climatic class Classe climatique | 4 / 38°C | | | | | | 5 / 40°C | | |
| Tensión/Frecuencia Electrical data Tension électrique | 230V/1ph/50Hz | | | | | | | | |
| Controlador Controller Régulateur | Digital IP65 | | | | | | | | |
| Material Material [EXT/INT] Matériel | AISI 304 | | | | | | | | |
| Espesor Thickness Épaisseur | 75 | | | | | | | | |
| Aislamiento Isolation Isolation | 40kg/m ³ / Free CFC's / Zero ODP-GWP | | | | | | | | |
| Capacidad Capacity Capacité | 260/260 | 560/560 | 560 | 1240 | 560 | 1240 | 560 | 1240 | |
| Puertas Doors Portes | 2 | 2 | 1 | 2 | 1 | 2 | 1 | 2 | |
| Nº parrillas / Guías Nº shelves / Slides Nº de grilles / Glissière | 3 (530x650) | 6 (530x650) | 4 (530x650) | 8 (530x650) | 4 (530x650) | 8 (530x650) | Nº contenedores / Containers 7 | Nº contenedores / Containers 14 | |
| Sistema de frío Cooling System Système de froid | Forzado / Forced air / Ventilé | MONOBLOCK Forzado / Forced air / Ventilé | | | | | | | |
| Desescarche Defrost Dégivrage | Parada compres. (+) Gas caliente (-) Compressor off (+) Hot gas (-) Arrêt compres. (+) Gaz chaud (-) | Parada de compresor / Compressor off / Arrêt du compresseur | | Gas caliente / Hot gas / Gaz chaud | | Parada compres./ Compressor off/ Arrêt compres. | | | |
| Expansión Expansion Expansion | Capilar(+)/ V. Exp(-) Cap(+)/ Exp. valve(-) Cap(+)/ Dét. Th.(-) | Capilar / Capillary / Capillaire | | | | Válv. Expansión/ Expansion valve/ Détendeur thermostatique | | Capilar/ Capillary / Capillaire | |
| Potencia Power Puissance | 680 | 910 | 372 | 420 | 699 | 1550 | 210 | 374 | |
| Potencia frig. Cooling capacity Puissance Frig. | 370 / 445 | 370 / 583 | 690 | | 723 | 1446 | 370 | 690 | |
| Consumo Consumption Consommation | - | | | | | | 1,54 | 2,55 | |
| Clase energética Energy class Classe Énerg. | - | | | | | | C | B | |
| Refrigerante Refrigerant Gaz | R-290 | | | | | | | | |
| Opcional Optional Options | Manejo control digital bluetooth o wifi / Operating digital control bluetooth or wifi / Trait. de contrôle digital bluetooth ou wifi Ruedas / Casters / Roulettes (705X16=2; 705X17=2) | | | | 115V/1ph/60Hz BT: + 3% Refr: Sin incremento / No increase / Sans supplément 151 € 230V/1ph/60Hz Sin incremento / No increase / Sans supplément 170 € | | | | |
| | Parrilla / Wire shelf / Grille (502X91) 54 € Ruedas / Casters / Roulettes (705X16=2; 705X17=2) 143 € Juego de guías / Slides (GUIAL0320603) 45 € Barra carnicera / Meat bar set / Barre à viande (BCAN) 201 € | Parrilla / Wire shelf / Grille (502X91) 54 € Parrilla inoxidable / Stainless steel wire shelf / Grille Inox (502X58) 101 € Iluminación Led RGB con cambio de color (por puerta) / Led lighting RGB change of colour (per door) / LED RGB avec changement de couleur (par porte) 68 € | | Juego de guías / Slides / Jeu de Glissières (GUIAL0125641; GUIAL0225641) 45 € Contenedor polipropileno / Polypropylene container / Conteneur de polypropylène (501X08) (501X08) 95 € | | | | | |

Serie / Series / Série **AGB 700/1400L**

+Info: www.infrico.com

AGB 1402 BT CR



Controlador digital IP 65.
Digital control IP65
Contrôleur digital IP 65.



Parrillas reforzadas
Reinforced shelves
Grilles renforcées

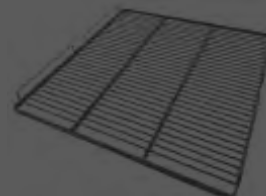

Triple acristalamiento templado,
bajo emisor con carga de Argón
(4-12-3-12-4)

Triple tempered glass, low
emission with Argon charge
(4-12-3-12-4)

Triple vitrage trempé à faible
émissivité avec Argon
(4-12-3-12-4)



Contenedor polipropileno
Polypropylene container
Conteneur de polypropylène

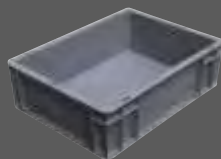

600mm x 400mm x 150mm

AGB PESC

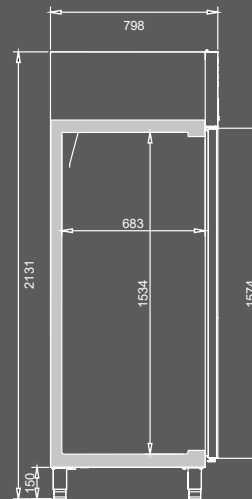

AGB 701 PESC



Armario refrig. GN2/1

GN2/1 refrigerator reach in /
Armoire posit. GN2/1

Armario refrig. Euronorm 600x400 Pastelería /

Euronorm 600x400 pastry reach in refrig. /
Armoire posit. Euronorme 600x400 pâtisserie

AGB 700L INVERTER

PASTELERÍA / PASTRY / PÂTISSERIE

A+
INVERTER

 MODELO
MODELE
MODÈLE

AGB 701 A

AGB701 PAST

AGB1402 PAST

AGB701 BT PAST

AGB1402 BT PAST

| Precio Price Prix | 3.411 € | 3.045 € | 4.990 € | 3.995 € | 6.047 € |
|--|--|--|--------------------------------|---|-----------------------------|
| Medidas Measures [mm] Mesures | 687 x 794 x 2130 mm. | 687 x 794 x 2130 mm. | 1385 x 794 x 2130 mm. | 687 x 794 x 2130 mm. | 1385 x 794 x 2130 mm. |
| Temperatura Temperature Température | -2°C/+8°C | -2°C/+8°C | | -18°C | |
| Clase Climática Climatic class Classe climatique | 5 / 40°C | 5 / 40°C | | 4 / 38°C | |
| Tensión/Frecuencia Electrical data Tension électrique | 230V/1ph/50Hz | | | | |
| Controlador Controller Régulateur | Digital IP65 | | | | |
| Material Material [EXT/INT] Matériel | AISI 304 | | | | |
| Espesor Thickness Épaisseur | 75 | | | | |
| Aislamiento Isolation Isolation | 40kg/m ³ / Free CFC's / Zero ODP-GWP | | | | |
| Capacidad Capacity Capacité | 560 | 560 | 1240 | 560 | 1240 |
| Puertas Doors Portes | 1 | 1 | 2 | 1 | 2 |
| Nº parrillas / Guías Nº shelves / Slides Nº de grilles / Glissière | 3 [530x650] | 0/18 | 0/36 | 0/18 | 0/36 |
| Sistema de frío Cooling System Système de froid | MONOBLOCK | | Forzado / Forced air / Ventilé | | |
| Desescarche Defrost Dégivrage | Parada compres./ Compressor off/ Arrêt compres. | Parada de compresor / Compressor off / Arrêt du compresseur | | Gas caliente / Hot gas / Gaz chaud | |
| Expansión Expansion Expansion | Válv. de expans. Electrónica / Electronic expansion valve / Valve d'expans. Electronique | Capilar / Capillary / Capillaire | | Válv. Expansión/ Expansion valve/ Détendeur thermostatique | |
| Potencia Power Puissance | 110 | 210 | 420 | 683 | 1054 |
| Potencia frig. Cooling capacity Puissance Frig. | [W A -10°C] | 334 | 370 | 644 | 1010 |
| Consumo Consumption Consommation | [kWh/ 24h] | 0,94 | 1,54 | 2,55 | 7,80 |
| Clase energética Energy class Classe Énerg. | A | C | B | D | D |
| Refrigerante Refrigerant Gaz | R-600a | R-290 | | | |
| Opcional Optional Options | - | Manejo control digital bluetooth o wifi / Operating digital control bluetooth or wifi / Trait. de contrôle digital bluetooth ou wifi 151 € Ruedas / Casters / Roulettes [705X16=2; 705X17=2] 170 € Parrilla / Wire shelf / Grille [502X26] 57 € Juego de guías / Set of Slides / Jeu de Glissières [GUAL0120641; GUAL0220641] 45 € Bandeja / Tray / Plateau 600x400 [A850P41] 52 € Cerradura / Lock / Serrure [506X209; 506X210] 45 € | | | |
| | | 115V/1ph/60Hz 230V/1ph/60Hz Sin incremento / No increase / Sans supplément | | 115V/1ph/60Hz + 3% 230V/1ph/60Hz Sin incremento / No increase / Sans supplément | |

+Info: www.infrico.com

AGB 701 A

Clase energ.
Energy class
Classe Énerg.

A+
INVERTER



Compresor de velocidad variable
Variable-capacity compressor
Compresseur vitesse variable



Costados embutidos
Stamped inner sides
Intérieurs emboutis

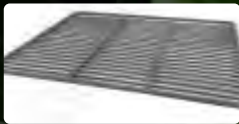

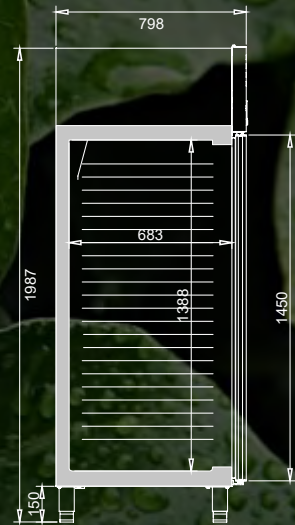

Parrillas reforzadas
Reinforced wire shelves
Grilles renforcées



36 bandejas 600x400 [no incluidas]
36 trays 600x400 [not included]
36 plateaux 600x400 [non inclus]

AGB 1402 BT PAST 



Opcional: Manejo control digital por WiFi o  Bluetooth®
Optional: Operating digital control by WiFi or  Bluetooth®

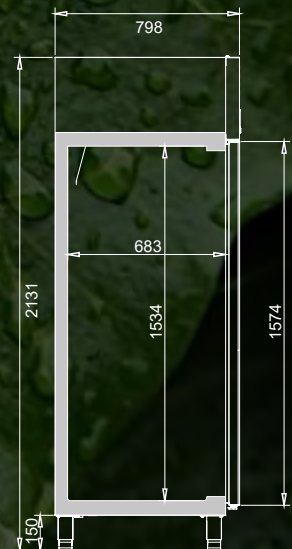

Armarios Euronorm 800x600 pastelería-heladería / Armario Cátering Euronorm 800x600 pastry-ice cream reach in / Catering reach in Armoire Euronorme 800x600 pâtisserie-glace / Armoire traiteur catering

HELADERÍA-PASTELERÍA / ICE CREAM-PASTRY / GLACE-PÂTISSERIE

Cátering / Catering / Catering

MODELO
MODELE
MODÈLE



AGB901



AGB901BT



AC600 R



AC600 BT

| Precio Price Prix | 3.256 € | 3.914 € | 2.115 € | 2.314 € |
|--|---|---|---|---|
| Medidas Measures [mm] Mesures | 796 x 960 x 2130 mm. | 796 x 960 x 2130 mm. | 750 x 752 x 1887 mm. | 750 x 752 x 1887 mm. |
| Temperatura Temperature Température | -2°C/+8°C | -22°C/-25°C | 0°C/+8°C | -18°C/-25°C |
| Clase Climática Climatic class Classe climatique | 5 / 40°C | 4 / 38°C | | |
| Tensión/Frecuencia Electrical data Tension électrique | 230V/1ph/50Hz | | | |
| Controlador Controller Régulateur | Digital IP65 | | | |
| Material Material [EXT/INT] Matériel | AISI 304 | | AISI 430 | |
| Espesor Thickness Épaisseur | 75 | | 60 | |
| Aislamiento Isolation Isolation | 40kg/m ³ / Free CFC's / Zero ODP-GWP | | | |
| Capacidad Capacity Capacité | 785 | | 542 | |
| Puertas Doors Portes | 1 | | | |
| Nº parrillas / Guías Nº shelves / Slides Nº de grilles / Glissière | 6/6 (600X800) | | 3 (600X500) | 12+1 contenedores / containers / containers |
| Sistema de frío Cooling System Système de froid | MONOBLOCK Forzado / Forced air / Ventilé | | Forzado / Forced air / Ventilé | Estático / Static / Statique |
| Desescarche Defrost Dégivrage | Parada compresor / Compresor off / Arrêt compresseur. | Gas caliente / Hot gas / Gaz chaud | Parada compresor / Compresor off / Arrêt compresseur. | |
| Expansión Expansion Expansion | Capilar/ Capillary / Capillaire | Válv. expans. Termostática / Thermostatic expans. valve/ Valv. d'expans. Thermostatique | Capilar / Capillary / Capillaire | |
| Potencia Power Puissance | 370 | 680 | 240 | 230 |
| Potencia frig. Cooling capacity Puissance Frig. | 690 | 742 | 370 | 304 |
| Consumo Consumption Consommation | 1,60 | 7,95 | - | |
| Clase energética Energy class Classe Énerg. | B | D | - | |
| Refrigerante Refrigerant Gaz | R-290 | | | |
| Opcional Optional Options | 115V/1ph/60Hz 230V/1ph/60Hz Sin incremento / No increase / Sans supplément | 115V/1ph/60Hz + 3% 230V/1ph/60Hz Sin incremento / No increase / Sans supplément | 115V/1ph/60Hz 230V/1ph/60Hz Sin incremento / No increase / Sans supplément | 115V/1ph/60Hz + 3% 230V/1ph/60Hz Sin incremento / No increase / Sans supplément |
| | Manejo control digital bluetooth o wifi / Operating digital control bluetooth or wifi / Trait. de contrôle digital bluetooth ou wifi Parrilla / Wire shelf / Grille [502X94] 151 € Bandeja / Tray / Plateau 600x400 [A850P41] 61 € Cubeta helados 5 L. / 5 L. ice cream tray / Bacs à glace 5 L. [501X32] 52 € Cerradura / Lock / Serrure [506X209] 55 € 45 € | Parrilla / Wire shelf / Grille [502X76] 51 € Ruedas / Casters / Roulettes (705X16; 705X17 -2) 170 € Contenedor / Container / Container 500x300x180mm [501X44] 32 € Contenedor / Container 600x400x220mm [501X45] 47 € | | |

Serie / Series / Série **AGB 900L**
 Serie / Series / Série **AC 600L**

+Info: www.infrico.com

AGB 901 BT 

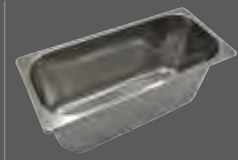

Capacidad 54 cubetas de helado de 5 L. [no incluidas]

Capacity 54 ice-cream 5 L. Trays [not included]

Capacité 54 bacs à glace 5 L. [non inclus]

AC 600 BT

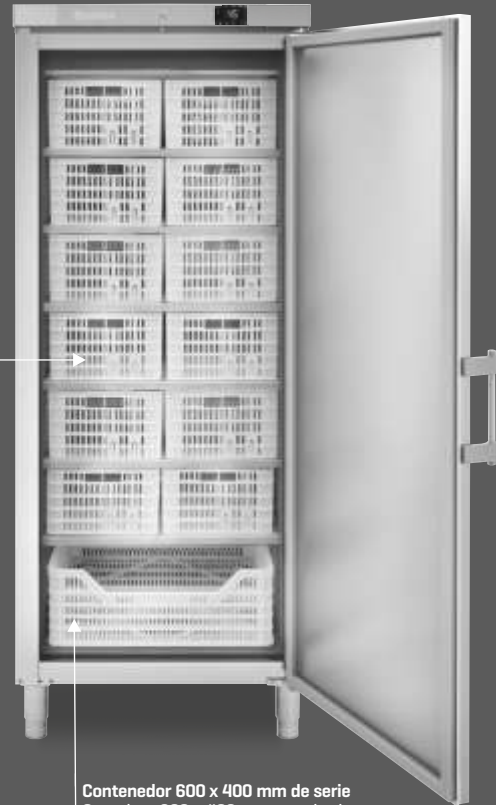

Contenedor 600 x 400 mm de serie
 Container 600 x 400 mm standard
 Container 600 x 400 mm de série

Contenedor 500 x 300 mm de serie
 Container 500 x 300 mm standard
 Container 500 x 300 mm de série



AGB 901

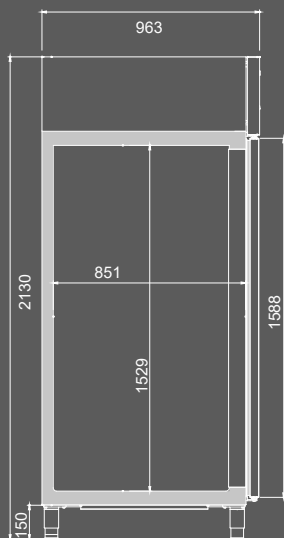

AC 600 BT

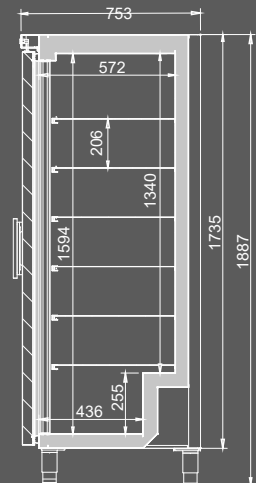

Armario Fermentación 600x800

Retarder proofer cabinet 600x800
Armoire de fermentation 600x800



FC900BT



FC900BT CR

| MODELO MODELE MODÈLE | FC900BT | FC900BT CR |
|---|---|----------------------------|
| Precio Price Prix | 6.932 € | 7.422€ |
| Medidas Measures [mm] Mesures | 796 x 960 x 2130 mm. | 796 x 960 x 2130 mm. |
| Temperatura Temperature Température | -18°C/+35°C | |
| Clase Climática Climatic class Classe climatique | 4 / 38°C | |
| Tensión/Frecuencia Electrical data Tension électrique | 230V/1ph/50Hz | |
| Controlador Controller Régulateur | Digital IP65 | |
| Material Material [EXT/INT] Matériel | AISI 304 | |
| Espesor Thickness Épaisseur | 75 | |
| Aislamiento Isolation Isolation | 40kg/m ³ / Free CFC's / Zero ODP-GWP | |
| Capacidad Capacity Capacité | 785 | |
| Puertas Doors Portes | 1 | |
| Nº parrillas / Guías Nº shelves / Slides Nº de grilles / Glissière | 0/20 | |
| Sistema de frío Cooling System Système de froid | Forzado / Forced air / Ventilé | |
| Desescarche Defrost Dégivrage | Gas caliente / Hot gas / Gaz chaud | |
| Expansión Expansion Expansion | Válv. expans. Termostática / Thermostatic expans. valve/ Valv. d'expans. Thermostatique | |
| Potencia Power Puissance | 1762 | |
| Potencia frig. Cooling capacity Puissance Frig. | Frío / Cool / Froid 1600 Calor / Heat / Chauffé 750 | |
| Consumo Consumption Consommation | - | |
| Clase energética Energy class Classe Énerg. | - | |
| Refrigerante Refrigerant Gaz | R-290 | |
| Opcional Optional Options | 115V/1ph/60Hz + 3 % 230V/1ph/60Hz Sin incremento / No increase / Sans supplément | |
| | Manejo control digital bluetooth o wifi / Operating digital control bluetooth or wifi / Trait. de contrôle digital bluetooth ou wifi 151 € Parrilla / Grate / Grille 800X600 [502X94] 57 € Parrilla/ Grate / Grille 600X400 [502X26] 47 € Juego guías/Slides/Jeu Glissières [GUIALO120806; GUIALO220806] 45 € Cerradura/Lock/Serrure [506X209] 39 € KIT Filtro agua / Water filter / Filtre à eau [4600x0018] 168 € Bandeja 600x400/ Tray 600x400 / Plateau 600x400 160 € | |

Serie / Series / Série **FC 900 BT**

+Info: www.infrico.com

FC 900 BT CR



Opción Kit filtro de agua
Option Kit water filter
Optionel Kit filtre à eau



Video del producto

Product Video
Vidéo du produit



Infrico Youtube

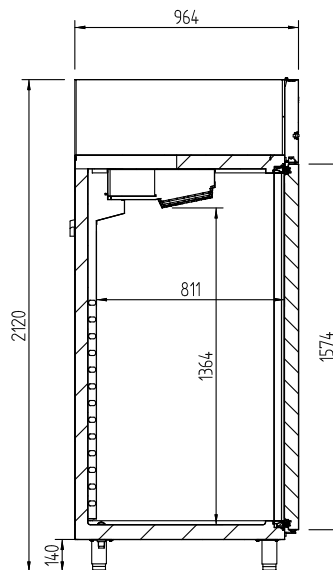

Cambiar tiempo de fin de ciclo
Change end of cycle time
Modifier la durée de fin de cycle



Cambiar valor de temperatura
Change temperature setpoint
Modifier la température de consigne



Cambiar valor de humedad
Change humidity setpoint
Modifier la valeur de l'humidité

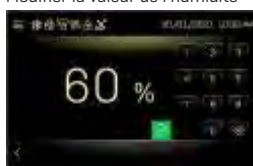

Armarios para carros GN2/1, 600x400, 650x450, 800x600, 1300/2700L /
GN2/1, 600x400, 650x450, 800x600, 1300/2700L roll-in /
 Armoire à chariot GN2/1, 600x400, 650x450, 800x600, 1300/2700L

MODELO
 MODELE
 MODÈLE



RIC1P



RIC1P BT



RIC2P

RIC1P TH
Pasante/Pass-thru/Traversante

| Precio Price Prix | 6.063 € | 6.590 € | 8.038 € | 6.790 € |
|---|--|---|---|-----------------------------|
| Medidas Measures [mm] Mesures | 876 x 1090 x 2414 mm. | 876 x 1090 x 2414 mm. | 2000 x 1090 x 2414 mm. | 940 x 1180 x 2414 mm. |
| Temperatura Temperature Température | 0°C/+8°C | -18°C | 0°C/+8°C | |
| Clase Climática Climatic class Classe climatique | 5 / 40°C | 4 / 30°C | 5 / 40°C | |
| Tensión/Frecuencia Electrical data Tension électrique | 230V/1ph/50Hz | | | |
| Controlador Controller Régulateur | Digital IP65 | | | |
| Material Material [EXT/INT] Matériel | AISI 304 | | | |
| Espesor Thickness Épaisseur | 80 | | | |
| Aislamiento Isolation Isolation | 40kg/m ³ / Free CFC's / Zero ODP-GWP | | | |
| Capacidad Capacity Capacité | 1224 | 1224 | 2937 | 1245 |
| Puertas Doors Portes | 1 | 1 | 2 | 1 |
| Nº parrillas / Guías Nº shelves / Slides Nº de grilles / Glissière | - | | | |
| Sistema de frío Cooling System Système de froid | MONOBLOCK Ventilado / Forced Air / Ventilé | | | |
| Desescarche Defrost Dégivrage | Parada compresor / Compresor off / Arrêt compresseur. | Gas caliente/ Hot Gas / Gaz Chaude | Parada compresor / Compresor off / Arrêt compresseur. | |
| Expansión Expansion Expansion | Capilar/ Capillary / Capillaire | Válv. expans. Termostática / Thermostatic expans. valve/ Valv. d'expans. Thermostatique | Capilar/ Capillary / Capillaire | |
| Potencia Power Puissance | 380 | 870 | 760 | 380 |
| Potencia frig. Cooling capacity Puissance Frig. | 687 | 1011 | 1374 | 687 |
| Consumo Consumption Consommation | 3,90 | 15,6 | 7,4 | 4,86 |
| Clase energética Energy class Classe Énerg. | - | | | |
| Refrigerante Refrigerant Gaz | R-290 | | | |
| Tamaño máximo Carro Size maximum Rack Dimensions max. Chariot | 700 x 1880 x 880 mm | | | |
| Opcional Optional Options | Manejo control digital bluetooth o wifi / Operating digital control bluetooth or wifi / Trait. de contrôle digital bluetooth ou wifi 151 € Carro / Rack / Chariot (455x635x1787) GN 1/1 (CBGN2011) 642 € Carro / Rack / Chariot (660x755x1787) GN2/1 (CBGN2021) 698 € Carro / Rack / Chariot (530x705x1787) 600x400 mm (CBE20) 705 € | | | |

Serie / Series / Série **RIC**

+Info: www.infrico.com



RIC1PTH
Pasante / Pass-thru / Traversante

Nuevo Controlador digital IP 65.
New Digital control IP65
Contrôleur digital IP 65.



RIC2P



RIC 1P BT

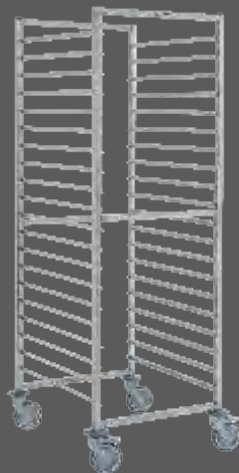

CBGN 2011
CBGN 2021

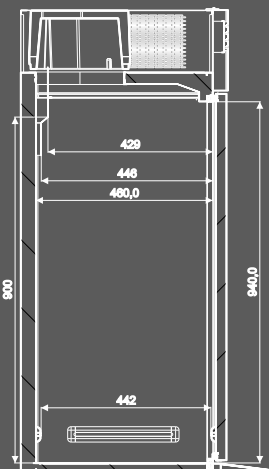

RIC 1P/2P

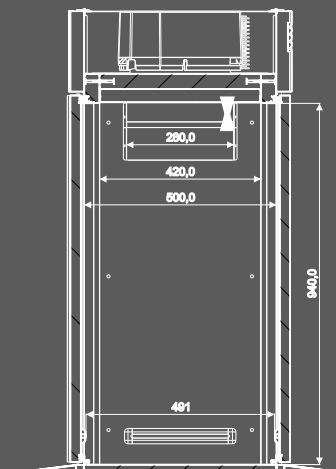

RIC1PTH
Pasante/Pass-thru/Traversante





AS



Abatidores

Blast Chillers / Cellules de Réfrigérissement

4





Función & Ciclos Work & Cycles Fonction et cycles

142-143

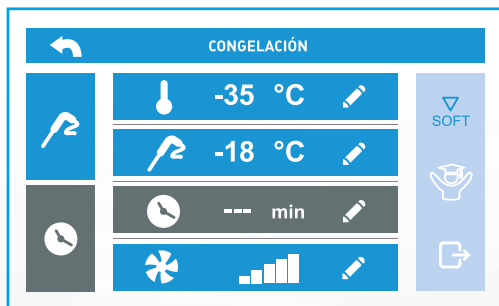

Serie / Series / Série

3, 5, 6, 7, 10, 14 NIVELES / LEVELS / NIVEAUX



ABT 144-145

Serie / Series / Série

20 NIVELES / LEVELS / NIVEAUX



ABT 146-147

Serie / Series / Série

20 DOBLES / DOUBLES / DOUBLES

Serie / Series / Série
MODULAR / MODULAR / MODULAIRE



ABT 148-151



4. Abatidores

Blast Chillers / Cellules de Refroidissement

Controlador táctil integrado en la puerta.
Diseño innovador.
USB integrado en el lateral.

Contrôleur tactile intégré dans la porte. Conception innovative.
USB intégré sur le côté.

Touch controller integrated in the door.
Innovative design.
USB integrated in the side.



Refrigeración / Refrigeration / Réfrigération

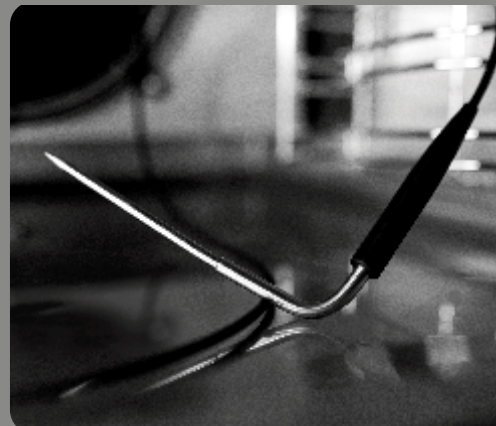

ABT5L



ABT71M



ABT101L

Compatibles con diferentes tipos de carro.

Compatible with different types of trolleys.

Compatible avec différents types de chariots.

[Rational, Unox, Convothem, etc]



Rampa opcional en los modelos ABT20 [excepto S].

Optional ramp on ABT20 models [except S].

Rampe en option sur les modèles ABT20 [sauf S].



Nuevo tirador en los modelos ABT20.

New handle on ABT20 models.

Nouvelle poignée sur les modèles ABT20.



ABT20 1CBI



ABT20 2P

Nueva cuba recoge aguas en ABT20.

New water collecting tank in ABT20 model.

Nouveau bac de rétention d'eau dans le modèle ABT20.



Función del abatidor y ciclos de trabajo

How blast chillers work & cycle functions

Fonction de la cellule de refroidissement et cycles de travail

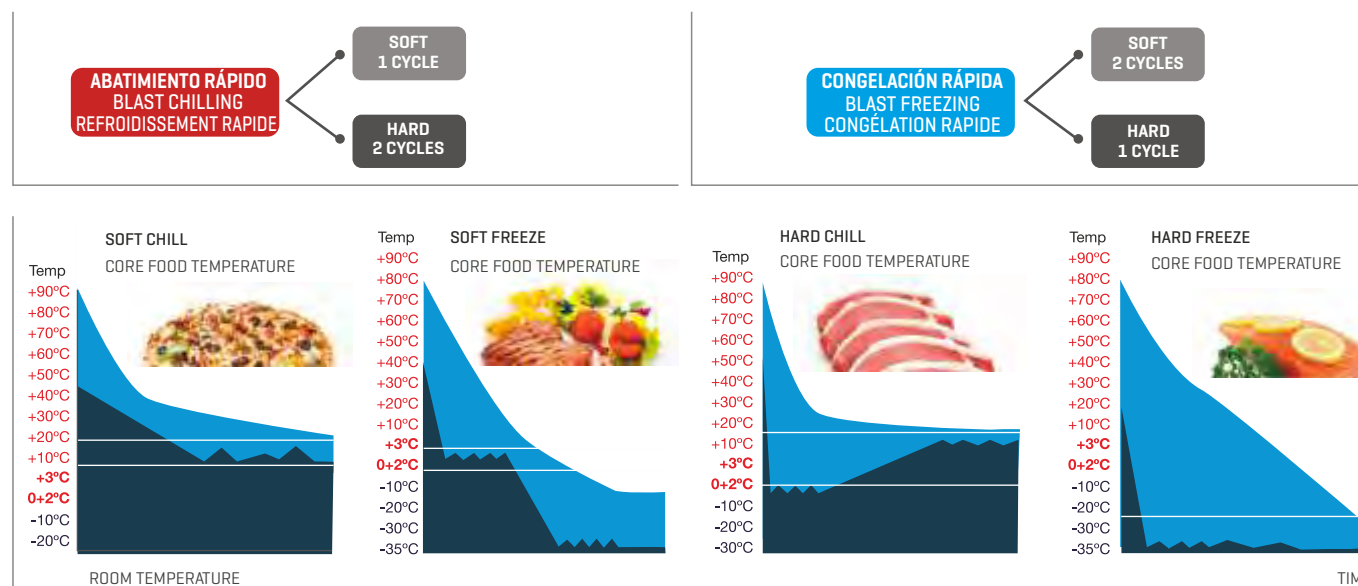

Función de abatidor

Los abatidores permiten reducir en un tiempo muy breve la temperatura en el corazón de los alimentos, sean cocinados o frescos, conservando sus características de frescura, higiene y calidad, disminuyendo los riesgos de proliferación bacteriana.

- La manera tradicional de conservar los alimentos cocinados ha sido dejar enfriar los alimentos al aire libre hasta que la temperatura del alimento alcance una temperatura ideal para su conservación en el refrigerador.

- La fase de enfriamiento entre +65°C y +10°C es un intervalo de tiempo que compromete las características naturales del producto [humedad, consistencia, aroma, color] y lo somete a la agresión y a la consecuente proliferación bacteriana.

- Con los ABATIDORES INFRICO se persigue reducir al máximo la permanencia de los alimentos en este intervalo crítico de temperaturas.

How blast chillers work

Blast chillers quickly reduce the core temperature of the products, whether they are cooked or fresh, conserving their fresh texture, hygiene and quality, whilst reducing the risk of bacteria generation.

- The traditional method of storing cooked food has always been to leave it to cool naturally until it reaches a suitable temperature to store in the refrigerator.

- During the period when the core temperature falls from +65°C and +10°C, the food will lose a lot of its natural characteristics, such as moisture, consistency, aroma and colour. Furthermore, this is when bacteria begin to grow.

- INFRICO BLAST CHILLERS are designed to reduce the time period for this critical change in temperature.

Fonction cellule de ref.

Les cellules de refroidissement permettent de réduire très rapidement la température au cœur des aliments, qu'ils soient cuits ou frais, tout en conservant leurs caractéristiques de fraîcheur, d'hygiène et de qualité, et en réduisant le risque de prolifération bactérienne.





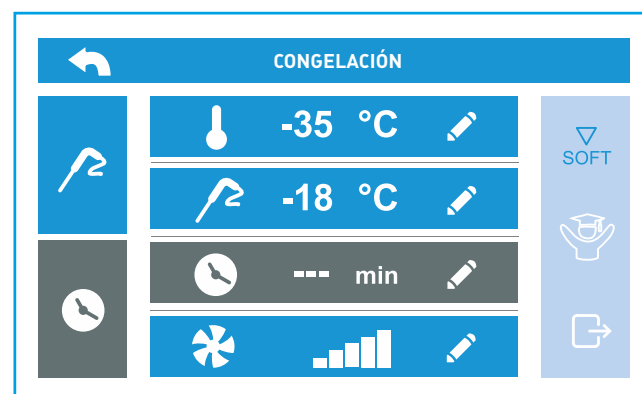
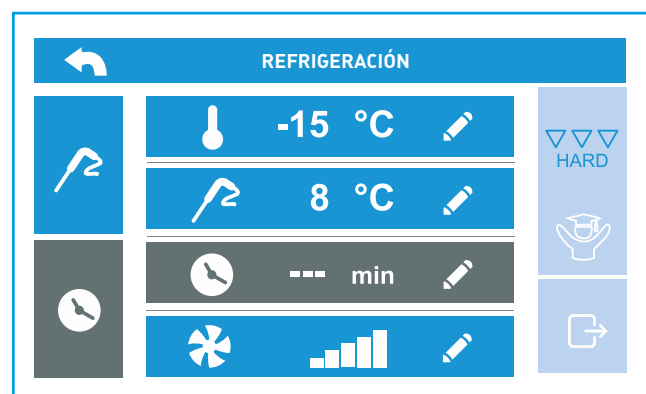

- La manière traditionnelle de conserver les aliments cuisinés est de les laisser refroidir à l'air libre jusqu'à ce que leur température atteigne une valeur idéale pour leur conservation au réfrigérateur.

- La phase de refroidissement de +65°C à +10°C est un espace de temps qui compromet les caractéristiques naturelles du produit [humidité, consistance, arôme et couleur] et l'expose à l'agression ainsi qu'à la prolifération bactérienne qui peut en suivre.

- Les CELLULES DE REFROIDISSEMENT INFRICO, sont conçues pour réduire au maximum la permanence des aliments dans cet intervalle critique de températures.



CARACT. PRINCIPALES

-  Diseño elegante, ausencia de espesor y facilidad de uso.
-  Opción ciclos personalizados con 3 fases de regulación.
-  Grado de protección de la interfaz del usuario IP65.
-  Gestión de ciclos de abatimiento y sobrecongelación, por temperatura y por tiempo, con función "hard/soft" y gestión de la intensidad.
-  Gestión del test para comprobar que la sonda pincho se ha colocado correctamente [incluidas las sondas de tipo "multipoint"].
-  Representación gráfica en tiempo real del ciclo de abatimiento/sobrecongelación en curso.

MAIN FEATURES



- Stylish design, flush mounted, user-friendly.
- Option personalized cycles with 3 regulation phases.
- User interface with IP65 protection.
- Management of blast chilling and freezing cycles, both temperature and time controlled, with hard/soft and intensity management functions.
- Runs a test to check that the needle probe is correctly inserted [including multipoint probes].
- Real-time graphic display for blast chilling/freezing cycle in progress.

CARACT. PRINCIPALES

- Lignes élégantes et faciles d'utilisation.
- Option cycles personnalisés avec 3 phases de régulation.
- Haute protection de l'interface de l'utilisateur IP65.
- Gestion des cycles de refroidissement et de surgélation, par température et durée, avec la fonction « hard/soft » et gestion de l'intensité.
- Test pour vérifier si la sonde est correctement mise [inclues les sondes de type « multipoint »].
- Représentation graphique en temps réel du cycle de refroidissement et surgélation en cours.



VENTAJAS

-  Sonda calefactada.
-  Gestión de ciclos especiales [higienización pescado, descongelación, endurecimiento helado, etc...]
-  Posibilidad de personalizar 99 programas.

ADVANTAGES

- Heated probe.
- Management of special cycles [fish sanitation, thawing, ice cream hardening, etc.]
- Possibility to personalize 99 programs

AVANTAGES

- Sonde chauffée.
- Gestion des cycles spéciaux [hygiénisation du poisson, décongélation, durcissement de la glace, etc...]
- Possibilité de personnaliser 99 programmes.

Nuevos ciclos especiales como:
Higienización pescado,
descongelación,
endurecimiento helado, etc...

New special cycles:
Fish sanitation, ice cream
hardening, etc...

Nouveaux cycles spéciaux
comme:
hygiénisation du poisson,
décongélation,
durcissement de la glace, etc...

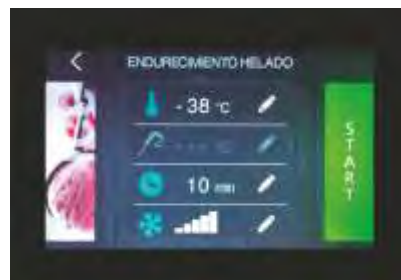
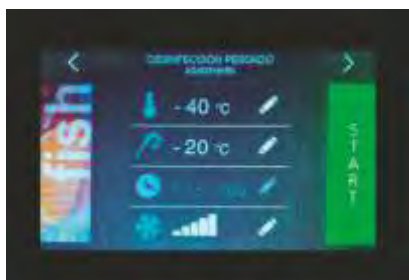
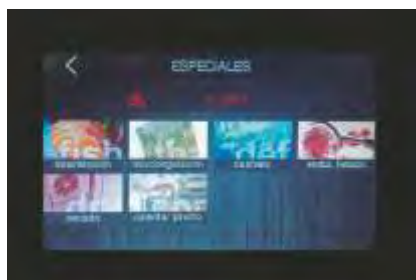









Abatidores y congeladores de temperatura / Blast chillers and freezers / Cellule de refroidissement et surgélation

3 - 5 Niveles / Levels / Niveaux

6 - 7 Niveles / Levels / Niveaux

10 - 14 Niveles / Levels / Niveaux

| MODELO MODELE MODÈLE |  |  |  |  |  |  |  |  |  |
|--|---|---|---|---|---|---|---|---|---|
| Precio Price Prix | 4.141 € | 5.476 € | 5.304 € | 5.639 € | 5.938 € | 6.754 € | 7.840 € | 10.254 € | 12.226 € |
| Medidas Measures [mm] Mesures | 721 x 711 x 536 mm. | 837 x 870 x 950 mm. | 837 x 724 x 800 mm. | 508 x 863 x 1059 mm. | 837 x 870 x 1120 mm. | 1468 x 700 x 940 mm. | 837 x 870 x 1730 mm. | 837 x 870 x 1730 mm. | 1072 x 1076 x 1950 mm. |
| Temperatura Temperature Température | +3°C / -38°C | | | | | | | | |
| Clase Climática Climatic class Classe climatique | 4 / 38°C | | | | | | | | |
| Tensión/Frecuencia Electrical data Tension électrique | 220V/1ph/50Hz | | | | | | 380V/3ph/50Hz | | |
| Controlador Controller Régulateur | Táctil / Touch-screen / Tactile IP65 | | | | | | | | |
| Material Material [EXT/INT] Matériel | AISI 304 | | | | | | | | |
| Espesor Thickness Épaisseur | 35 | 65 | | | | 65 | 65 | 65 | 65 |
| Aislamiento Isolation Isolation | 40kg/m ³ / Free CFC's / Zero ODP-GWP | | | | | | | | |
| Capacidad Capacity Capacité | 68 | 125 | 95 | 85 | 160 | 120 | 315 | 315 | 640 |
| Compresor Compressor Compresseur | 1/2 | 1 | | 1 | 1 1/4 | | 2 | 2 1/2 | 4 |
| Capacidad refrig./cong. Freezing capacity [Kg.] Rendement refroid./cong. | 10/5* | 20/12* | | 20/12* | 30/18* | | 40/25* | 50/30* | 80/50* |
| Distancia entre bandejas Distance between trays Distance entre bacs | 65 | | | | | | | | 80 |
| Nº Bandejas (Opcional) Trays (Optional) Nº Bacs (Option) | 3 GN 1/1 | 5 GN 1/1 600x400 | 5 GN 1/1 | 6 GN 1/1 | 7 GN 1/1 600x400 | 7 GN 1/1 | 10 GN 1/1 600x400 | 14 GN 1/1 600x400 | 10 GN 2/1 800x600 |
| Sistema de frío Cooling System Système de froid | Forzado / Forced-air / Forcé | | | | | | | | |
| Desescarche Defrost Dégivrage | Parada compresor / Compressor off / Arrêt du compresseur | | | | | | | | |
| Expansión Expansion Expansion | Válvula de expansión termostática / Thermostatic expansion valve / Détendeur thermostatique | | | | | | | | |
| Potencia Power Puissance | 761 | 1205 | 1412 | 1125 | 2409 | 2393 | 2250 | 2824 | 3517 |
| Potencia frig. Cooling capacity Puissance Frig. | 1296 | 1805 | | | 2609 | | 3723 | 5445 | 9766 |
| Opcional Optional Options | Esterilizador/Sterilizer/Stérilisateur (407x26) | | 1.300 € | | Bandeja 600x400 / 600x400 trays / Bac 600x400 (A850P41) | | 52 € | | |
| | Registador/Recorder/Enregistreur (308x59) | | 1.242 € | | Manejo control digital bluetooth o wifi/ Operating digital control bluetooth or wifi / Trait. de contrôle digital bluetooth ou wifi | | 151 € | | |
| | Bandejas inox GN 1/1 / Stainless Steel GN1/1 / Bacs Inox GN 1/1 (501x23) | | 57 € | | | | | | |
| | 115V/1ph/60Hz | | +6% | | 220V/1ph/50Hz | | Consultar | | |
| | 230V/1ph/60Hz | | +3% | | 220V/1ph/60Hz | | Consult | | |
| | | | | | 380V/3ph/60Hz | | Consultez | | |
| | | | | | 440V/1ph/60Hz | | | | |
| | Entrada bandeja / Trays entry / Entrée bac | | 1S 1C | | 1L GN 1/1 600x400 | | | | |

*Rendimientos probados según la norma EN17032

*Capacity tested according to EN17032 standard

*Rendement prouvé selon la norme EN17032

Serie / Series / Série **3 - 5 - 6 - 7 - 10 - 14**

+Info: www.infrico.com

ABT7 1M



ABT6 1C



ABT5 1L

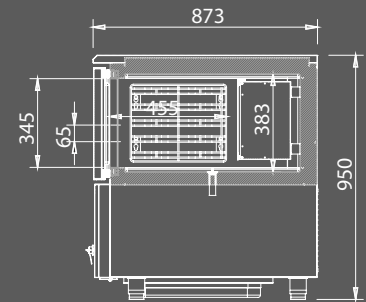

ABT10 1L



ABT10 1L

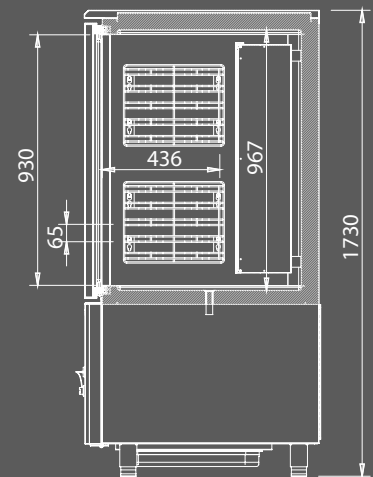

Abatidores y congeladores de temperatura / Blast chillers and freezers / Cellule de refroidissement et surgélation



MODELO
MODELE
MODÈLE

ABT20 1CBI ABT20 1C ABT20 2C ABT20 1S ABT20 2S ABT20 1P ABT20 2P ABT20 2CP ABT20 2SP ABT20 2PP

| | | | | | | | | | | |
|--|--|--|------------------------------|--|------------------------------|---|---|-------------------------------|------------------------------|------------------------------|
| Precio Price Prix | 19.395 € | 20.129 € | 25.993 € | 20.520 € | 26.523 € | 21.863 € | 27.902 € | 30.004 € | 30.534 € | 31.913 € |
| Medidas Measures [mm] Mesures | 1200 x 1125 x 2465 mm. | 1200 x 1125 x 2280 mm. | 1400 x 1325 x 2280 mm. | 1200 x 1125 x 2280 mm. | 1400 x 1325 x 2280 mm. | 1200 x 1120 x 2280 mm. | 1400 x 1420 x 2280 mm. | 1400 x 1325 x 2280 mm. | 1400 x 1325 x 2280 mm. | 1400 x 1420 x 2280 mm. |
| Temperatura Temperature Température | +3°C / -40°C | | | | | | | | | |
| Clase Climática Climatic class Classe climatique | 4 / 38°C | | | | | | | | | |
| Tensión/Frecuencia Electrical data Tension électrique | 380V/3ph/50Hz | | | | | | | | | |
| Controlador Controller Régulateur | Táctil / Touch-screen / Tactile IP65 | | | | | | | | | |
| Material Material [EXT/INT] Matériel | AISI 304 | | | | | | | | | |
| Espesor Thickness Épaisseur | 80 | | | | | | | | | |
| Aislamiento Isolation Isolation | 40kg/m ³ / Free CFC's / Zero ODP-GWP | | | | | | | | | |
| Capacidad Capacity Capacité | 1704 | 1861 | 2747 | 1686 | 2489 | 1861 | 2747 | 2747 | 2489 | 2747 |
| Capacidad refrig./cong. Freezing capacity [Kg.] Rendement refroid./cong. | 110 / 60* | | | | | | | 230 / 130* | | |
| Tamaño máximo Carro Size maximum Rack Dimensions max. Chariot | 700 x 1835 870 mm | 700 x 1900 870 mm | 830 x 1900 1070 mm | 700 x 1700 870 mm | 830 x 1700 1070 mm | 700 x 1900 870 mm | 830 x 1900 1070 mm | 830 x 1900 1070 mm | 830 x 1700 1070 mm | 700 x 1900 1070 mm |
| Sistema de frío Cooling System Système de froid | Forzado / Forced-air / Forcé | | | | | | | | | |
| Desescarche Defrost Dégivrage | Parada compresor / Compressor off / Arrêt du compresseur | | | | | | | | | |
| Expansión Expansion Expansion | Válvula de expansión termostática / Thermostatic expansion valve / Detendeur thermostatique | | | | | | | | | |
| Potencia Power Puissance | 6502 | 9773 | 9773 | 9693 | | 9943 | | 15343 | 15387 | 15443 |
| Potencia frig. Cooling capacity Puissance Frig. | 10073 [-10°C] / 5387 [-25°C] | | | | | | | 20869 [-10°C] / 11411 [-25°C] | | |
| Opcional Optional Options | Rampa / Ramp / Rampe [RAMABT21] | | | | 542 € | | Carro / Rack / Chariot [455x635x1787] GN 1/1 [CBGN2011] | | | 656 € |
| | Manejo control digital bluetooth o wifi / Operating digital control bluetooth or wifi / Trait. de contrôle digital bluetooth ou wifi | | | | 151 € | | Carro / Rack / Chariot [660x755x1787] GN2/1 [CBGN2021] | | | 782 € |
| | | 220V/1ph/50Hz 220V/1ph/60Hz 380V/3ph/60Hz 440V/1ph/60Hz | | Consultar Consult Consultez | | Opcional Condensadora ventilado axial o ventilado centrifugo o por agua Optional Condensing unit axial ventilated or centrifugal ventilated or water ventilated Options Unité de condensation à ventilation axiale ou centrifuge ou à ventilation par eau | | | 784 € | |

Motocondensadora incluida
Condensing unit included
Unité de condensation de série

*Rendimientos probados según la norma EN17032
*Capacity tested according to EN17032 standard
*Rendement prouvé selon la norme EN17032

Entrada carro / Car entry / Entrée chariot

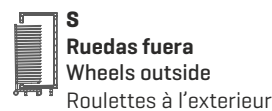

Serie / Series / Série **20**

+Info: www.infrico.com

ABT20 1S



ABT20 1CBI



Pantalla táctil de 7"
Tactil 7" screen
Écran tactile de 7"

Abatimiento rápido: +90°C a +3°C en menos de 90 minutos.
Congelación rápida: +90°C a -18°C en menos de 270 minutos.
Blas chilling: +90°C to +3°C in less than 90 minutes.
Blast freezing: +90°C to -18°C in less than 270 minutes.
Refroidissement rapide: +90°C à +3°C en moins de 90 minutes.
Congélation rapide: +90°C à -18°C en moins de 270 minutes.



Modelos S compatible con carro Rational
Models S compatible with Rational trolley
Modèles S compatible avec chariot Rational



CBGN 2011
CBGN 2021



ABT20 2P

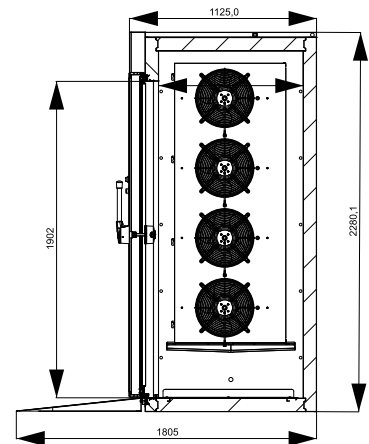

ABT20 1P



Abatidores y congeladores de temperatura / Blast chillers and freezers / Cellule de refroidissement et surgélation



MODELO
MODELE
MODÈLE

ABT20 3C

ABT20 4C

ABT20 3P

ABT20 4P

ABT20 3CP

ABT20 4CP

ABT20 3PP

ABT20 4PP

| Precio Price Prix | 45.810 € | | 50.861 € | | 47.594 € | | 52.644 € | | 54.530 € | | 59.735 € | | 56.314 € | | 61.518 € | |
|--|---|--|------------------------------|--|---|--|------------------------------|--|--|--|------------------------------|--|---|--|------------------------------|--|
| Medidas Measures [mm] Mesures | 1200 x 2025 x 2280 mm. | | 1400 x 2425 x 2280 mm. | | 1200 x 2120 x 2280 mm. | | 1400 x 2520 x 2280 mm. | | 1200 x 2025 x 2280 mm. | | 1400 x 2425 x 2280 mm. | | 1200 x 2120 x 2280 mm. | | 1400 x 2520 x 2280 mm. | |
| Temperatura Temperature Température | +3°C / -38°C | | | | | | | | | | | | | | | |
| Clase Climática Climatic class Classe climatique | 4 / 38°C | | | | | | | | | | | | | | | |
| Tensión/Frecuencia Electrical data Tension électrique | 380V/3ph/50Hz | | | | | | | | | | | | | | | |
| Controlador Controller Régulateur | Táctil / Touch-screen / Tactile IP65 | | | | | | | | | | | | | | | |
| Material Material [EXT/INT] Matériel | AISI 304 | | | | | | | | | | | | | | | |
| Espesor Thickness Épaisseur | 80 | | | | | | | | | | | | | | | |
| Aislamiento Isolation Isolation | 40kg/m ³ / Free CFC's / Zero ODP-GWP | | | | | | | | | | | | | | | |
| Capacidad Capacity Capacité | 3633 | | 5388 | | 3633 | | 5388 | | 3633 | | 5388 | | 3633 | | 5388 | |
| Capacidad refrig./cong. Freezing capacity [Kg.] Rendement refroid./cong. | 200 / 130* | | | | | | | | 400 / 260* | | | | | | | |
| Tamaño máximo Carro Size maximum Rack Dimensions max. Chariot | 700 x 1900 1770 mm | | 830 x 1900 2170 mm | | 700 x 1900 1770 mm | | 830 x 1900 2170 mm | | 700 x 1900 1770 mm | | 830 x 1900 2170 mm | | 700 x 1900 1770 mm | | 830 x 1900 2170 mm | |
| Sistema de frío Cooling System Système de froid | Forzado / Forced-air / Forcé | | | | | | | | | | | | | | | |
| Desescarche Defrost Dégivrage | Parada compresor / Compressor off / Arrêt du compresseur | | | | | | | | | | | | | | | |
| Expansión Expansion Expansion | Válvula de expansión termostática / Thermostatic expansion valve / Detendeur thermostatique | | | | | | | | | | | | | | | |
| Potencia Power Puissance | 19546 | | | | | | | | 30886 | | | | | | | |
| Potencia frig. Cooling capacity Puissance Frig. | 20146 [-10°C] / 11411 [-25°C] | | | | | | | | 41738 [-10°C] / 22822 [-25°C] | | | | | | | |
| Optional Options | Rampa / Ramp / Rampe [RAMABT21] | | 542 € | | Carro / Rack / Chariot [660x755x1787] GN2/1 [CBGN2021] | | 782 € | | Manejo control digital bluetooth o wifi / Operating digital control bluetooth or wifi / Trait. de contrôle digital bluetooth or wifi | | 151 € | | Carro / Rack / Chariot [530x705x1787] 600x400 mm [CBE20] | | 784 € | |
| | 220V/1ph/50Hz | | Consultar | | Opcional Condensadora ventilado axial o ventilado centrifugo o por agua | | | | 220V/1ph/60Hz | | Consult | | Optional Condensing unit axial ventilated or centrifugal ventilated or water ventilated | | | |
| | 380V/3ph/60Hz | | Consulte | | Options Unité de condensation à ventilation axiale ou centrifuge ou à ventilation par eau | | | | 440V/1ph/60Hz | | Consulte | | | | | |

Motocondensadora incluida
Condensing unit included
Unité de condensation de série

*Rendimientos probados según la norma EN17032
*Capacity tested according to EN17032 standard
*Rendement prouvé selon la norme EN17032

Entrada carro / Car entry / Entrée chariot



3C / 4C
Ruedas dentro
Casters inside
Roulettes à l'intérieur



3CP / 3PP / 4CP / 4PP
Potenciados
Powerfull
Plaine puissance



3P / 4P
Pasante
Pass-through
Traversante

Serie / Series / Série **20 (Doble / Double / Double)**

+Info: www.infrico.com



Pantalla táctil de 7"
Tactil 7" screen
Écran tactile de 7"



ABT20 4PP



Abatimiento rápido: +90°C a +3°C en menos de 90 minutos.
Congelación rápido: +90°C a -18°C en menos de 270 minutos.

Blast chilling: +90°C to +3°C in less than 90 minutes.
Blast freezing: +90°C to -18°C in less than 270 minutes.

Refroidissement rapide: +90°C à +3°C en moins de 90 minutes.
Congélation rapide: +90°C à -18°C en moins de 270 minutes.

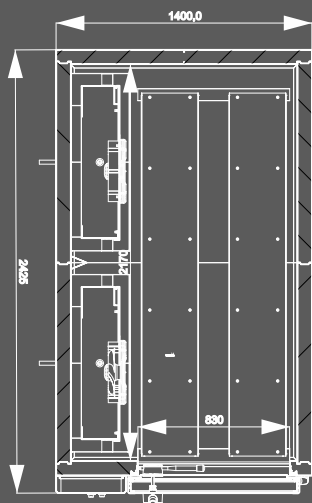

Planta / Floor plan / Plan d'étage

ABT20 4P

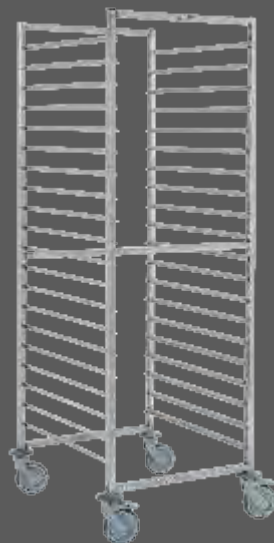

CBGN 2021 / CBGN 2011

Motocondensadora incluida
Condensing unit included
Unité de condensation de série



Abatidores tunel modular / Modular Blast chillers / Modulaires Cellule de refroidissement et surgélation

Abatidores Modulares

- Panel acero inox AISI 304 multiplicando por 2, 3, 4, etc, el número de carros de producto.
- Configuración de puertas pasantes en los extremos, y efecto túnel en el interior.
- Disponibles con unidades potenciadas a medida, o motocondensadoras por agua.
- Consultar proyectos a medida.

Modular Blast Chillers

- AISI 304 stainless steel panel increasing by 2, 3, 4, etc., the number of product trolleys.
- Configuration of through doors at the entry and exit, and tunnel effect inside.
- Available with customised powered units or water condensing units.
- Consult customised projects

Cellules de refroidissement modulaires

- Panneau en acier inoxydable AISI 304 multipliant par 2, 3, 4, etc, le nombre de chariots de produits.
- Configuration de portes traversantes à l'entrée et à la sortie, et effet tunnel à l'intérieur.
- Disponible avec des unités motorisées personnalisées ou des unités de condensation à eau.
- Consulter les projets personnalisés

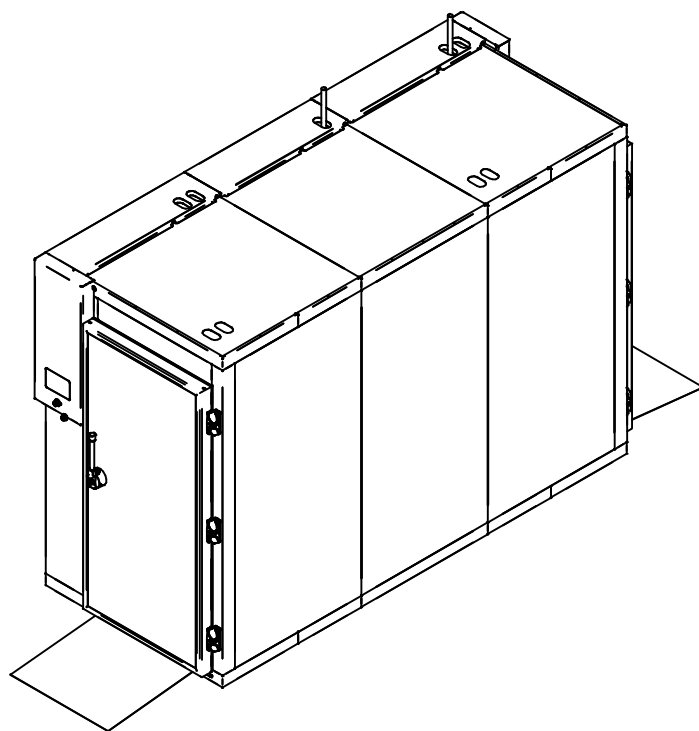

+Info: www.infrico.com



i-line

5





Serie / Series / Série

IABT

IABT3 1S

IABT5 1L

IABT10 1L 158-159

Serie / Series / Série

IEBIEB 160-161

Serie / Series / Série

IM600

IM P

IM PN

IM PCR 162-163

Serie / Series / Série

IM700

IM P

IM PN

IM PCR 164-165

Serie / Series / Série

IF600

IF P

IF PCR 166-167

Serie / Series / Série

IMC / IEST

IMC

IEST 168-169

Serie / Series / Série

**IAN
500/1000L**

IAN

IAN N

IAN CR 170-171

Serie / Series / Série

**IAG
700/1400L**

IAG

IAG N

IAG CR 172-173



5. i-Line

Refrigeración / Refrigeration / Réfrigération

Sistemas de frío ventilado. Bandejas evaporativas sin resistencia eléctrica para una mayor eficiencia energética. Sistemas de evaporación forzada. Evaporadores tratados con Epoxi de poliéster anticorrosión. Unidades sobredimensionadas y eficientes. Válvulas de expansión termostáticas y desescarches por gas caliente en baja temperatura. Marcos de puerta calefactados para evitar acumulación de hielo.

Forced air cooling systems. Energy-saving non-electric condensate pans. Forced evaporation systems. Evaporators treated with anti-corrosion polyester Epoxy. Oversized and efficient units. Expansion valves. Hot gas defrost. Heating door frames to prevent ice build-up.

Systèmes de froid ventilé. Bacs d'évaporation sans résistances électriques pour une meilleur efficacité énergétique. Systèmes d'évaporation forcé. Évaporateurs traités avec un époxy polyester anticorrosion. Unités efficaces et surdimensionnées. Valves d'expansion thermostatiques. Dégivrache par gaz chaud. Cadres de portes chauffés pour empêcher l'accumulation de glace.



5

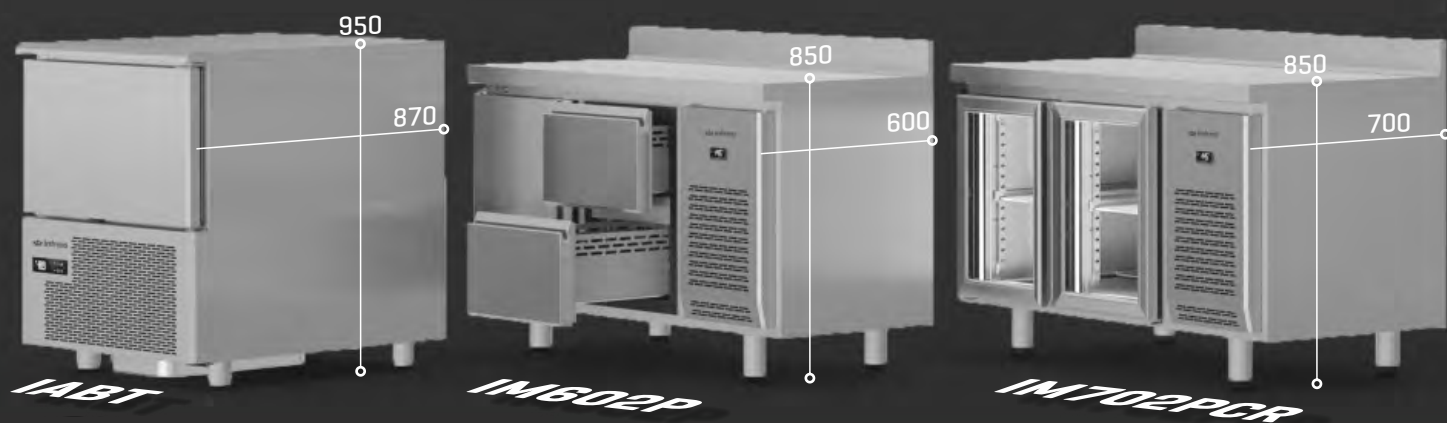

Cajones con guías telescópicas.

Drawers with telescopic guides.

Tiroirs avec glissières télescopiques.



Encimera reforzada con Omegas de serie [series 600/700].

Reinforced worktop with Omegas as standard [600/700 series].

Plan de travail renforcé avec Omegas en standard [séries 600/700].

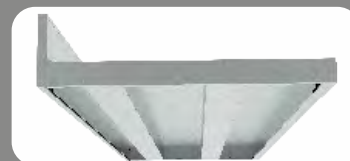

Soporte de cremallera para guías.

Rack and pinion support for guides.

Support de crémaillère pour guides.



Nuevo tirador en puertas de cristal /
New handle for glass doors /
Nouvelle poignée sur les portes en verre

Tirador de aluminio ergonómico completo,
integrado en el marco de puerta de cristal.

Ergonomic aluminium handle, fully integrated in
the glass door frame.

Poignée ergonomique en aluminium,
entièrement intégrée dans le cadre de la porte
en verre.



Puertas con tirador embutido y burlete plano desmontable "cleanless".

Inlay doors handle and flat gasket easily removable "cleanless".

Poignée de porte encastrée et joint plat facilement démontable "cleanless".



Abatidores y congeladores de temperatura 3, 5 y 10 niveles / Blast chillers and freezers 3, 5 & 10 levels / Cellule de refroidissement et surgélation 3, 5 et 10 niveaux

MODELO
MODELE
MODÈLE



IABT3 1S



IABT5 1L



IABT10 1L

| Precio Price Prix | 3.102 € | 4.068 € | 6.424 € |
|--|--|---------------------------|--|
| Medidas Measures [mm] Mesures | 721 x 711 x 536 mm. | 837 x 870 x 950 mm. | 837 x 724 x 800 mm. |
| Temperatura Temperature Température | +3°C / -38°C | | |
| Clase Climática Climatic class Classe climatique | 4 / 38°C | | |
| Tensión/Frecuencia Electrical data Tension électrique | 220V/2ph/50Hz | | 380V/3ph/50Hz |
| Controlador Controller Régulateur | Tácti / Touch-screen / Tactile IP65 | | |
| Material Material [EXT/INT] Matériel | AISI 430 | | |
| Espesor Thickness Épaisseur | 35 | 65 | 60 |
| Aislamiento Isolation Isolation | 40kg/m ³ / Free CFC's / Zero ODP-GWP | | |
| Capacidad Capacity Capacité | 68 | 125 | 485 |
| Compresor Compressor Compresseur | 1/2 | 1 | 2 |
| Blast chilling Freezing capacity [Kg.] Rendement refroid./cong. | 10/5* | 20/12* | 40/25* |
| Distancia entre bandejas Distance between trays Distance entre bacs | 65 | | |
| Nº Bandejas (Opcional) Trays (Optional) Nº Bacs (Option) | 3 GN 1/1 | 5 GN 1/1 600x400 | 10 GN 1/1 600x400 |
| Sistema de frío Cooling System Système de froid | Forzado / Forced-air / Forcé | | |
| Desescarche Defrost Dégivrage | Parada compresor / Compressor off / Arrêt du compresseur | | |
| Expansión Expansion Expansion | Válvula de expansión termostática / Thermostatic expansion valve / Détendeur thermostatique | | |
| Potencia Power Puissance | 761 | 1205 | 3498 |
| Potencia frig. Cooling capacity Puissance Frig. | 1296 | 1805 | 4299 |
| Opcional Optional Options | Esterilizador/Sterilizer/Stérilisateur (407x26) Registrador/Recorder/Enregistreur (308x59) Bandejas inox GN 1/1 / Stainless Steel GN1/1 / Bacs Inox GN 1/1 (501x23) Bandeja 600x400 / 600x400 trays / Bac 600x400 (A850P41) | | 1.300 € 1.242 € 57 € 52 € |

Entrada bandeja /
Trays entry /
Entrée bac

1S  1C
GN 1/1

1L 
GN 1/1
600x400

*Rendimientos probados según la norma EN17032
*Capacity tested according to EN17032 standard
*Rendement prouvé selon norme EN17032

Serie / Series / Série **IABT**

+Info: www.infrico.com

IABT10 1L

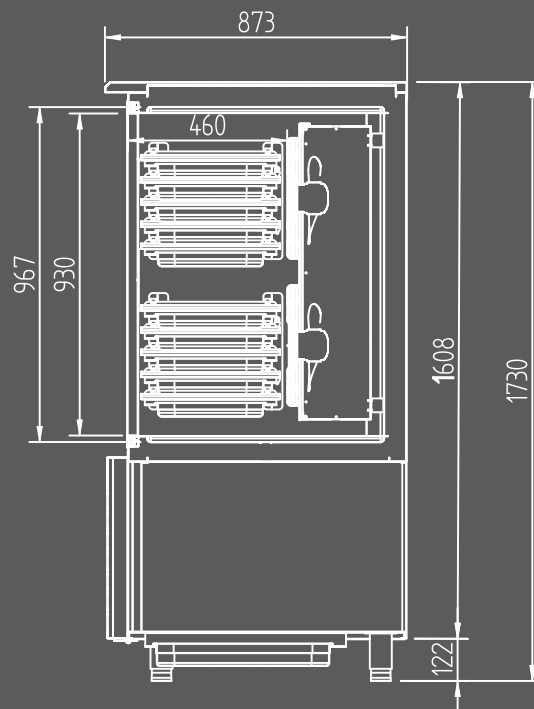

IABT10 1L

IABT5 1L

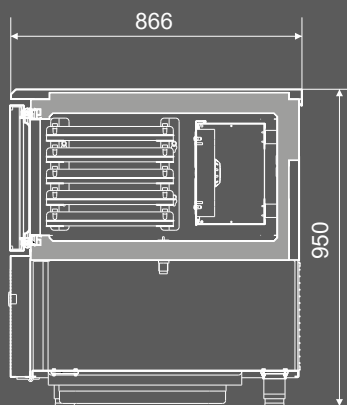
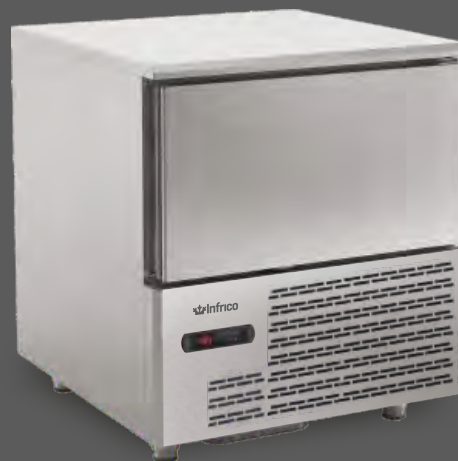

IABT5 1L

Refrigerador de botellas / Chest bottle cooler / Refrigerateur de bouteilles

MODELO
MODELE
MODÈLE



IEB 100



IEB 150



IEB 200







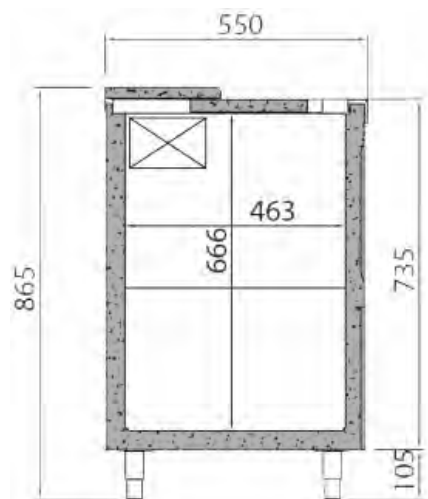
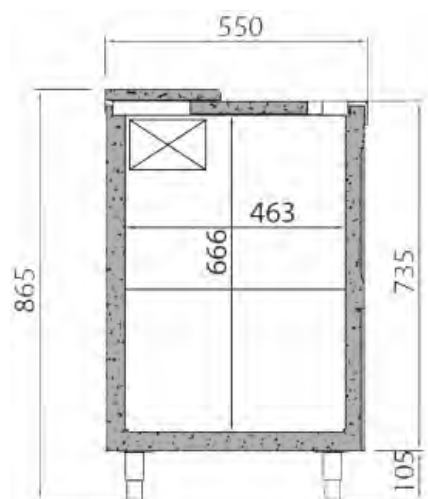

| Precio Price Prix | 937 € | | 1.144 € | | 1.346 € | |
|---|---|--|----------------------------|--------------|----------------------------|--|
| Medidas Measures [mm] Mesures | 1004 x 550 x 865 mm. | | 1479 x 550 x 865 mm. | | 1954 x 550 x 865 mm. | |
| Temperatura Temperature Température | +3°C/+6°C | | | | | |
| Clase Climática Climatic class Classe climatique | 4 / 38°C | | | | | |
| Tensión/Frecuencia Electrical data Tension électrique | 230V/1ph/50Hz | | | | | |
| Controlador Controller Régulateur | - | | | | | |
| Material Material [EXT/INT] Matériel | AISI 430 | | | | | |
| Espesor Thickness Épaisseur | 40 | | | | | |
| Aislamiento Isolation Isolation | 40kg/m ³ / Free CFC's / Zero ODP-GWP | | | | | |
| Capacidad Capacity Capacité | 265 | | 445 | | 620 | |
| Puertas Doors Portes | 2 | | 3 | | 4 | |
| Nº parrillas / Guías Nº shelves / Slides Nº de grilles / Glissière | - | | | | | |
| Sistema de frío Cooling System Système de froid | Forzado / Forced air / Ventilé | | | | | |
| Desescarche Defrost Dégivrage | - | | | | | |
| Expansión Expansion Expansion | Capilar / Capillary / Capillaire | | | | | |
| Potencia Power Puissance | 122 | | 180 | | | |
| Potencia fríg. Cooling capacity Puissance Frig. | 169 | | 370 | | | |
| Consumo Consumption Consommation | - | | | | | |
| Clase energética Energy class Classe Énerg. | - | | | | | |
| Refrigerante Refrigerant Gaz | R-600a | | | R-290 | | |
| Opcional Optional Options | - | | | | | |

Serie / Series / Série **IEB**

+Info: www.infrico.com



Mesas refrigeración, congelación y puertas de cristal / Refrigerated counters, freezers and glass doors / Dessertes positives et négatives

| MODELO MODELE MODÈLE |  |  |  |  |  |  |  |  |  |
|---|---|---|---|---|---|--|---|---|---|
| Precio Price Prix | 1.966 € | 2.287 € | 2.715 € | 2.387 € | 2.785 € | 3.386 € | 2.075 € | 2.486 € | 2.988 € |
| Medidas Measures [mm] Mesures | 1468 x 600 x 850 mm. | 1960 x 600 x 850 mm. | 2452 x 600 x 850 mm. | 1468 x 600 x 850 mm. | 1960 x 600 x 850 mm. | 2452 x 600 x 850 mm. | 1468 x 600 x 850 mm. | 1960 x 600 x 850 mm. | 2452 x 600 x 850 mm. |
| Temperatura Temperature Température [°C] | -2°C/+8°C | | | -18°C | | | +2°C/+6°C | | |
| Clase Climática Climatic class Classe climatique [°C] | 4 / 38°C | | | | | | | | |
| Tensión/Frecuencia Electrical data Tension électrique | 230V/1ph/50Hz | | | | | | | | |
| Controlador Controller Régulateur | Táctil Digital IP65 | | | | | | | | |
| Material Material [EXT/INT] Matériel | AISI 430 / Encimera-Worktop-Dessus AISI 304 | | | | | | | | |
| Espesor Thickness Épaisseur [mm] | 70 | | | | | | | | |
| Aislamiento Isolation Isolation [mm] | 40kg/m ³ / Free CFC's / Zero ODP-GWP | | | | | | | | |
| Capacidad Capacity Capacité [L] | 255 | 400 | 540 | 255 | 400 | 540 | 255 | 400 | 540 |
| Puertas Doors Portes | 2 | 3 | 4 | 2 | 3 | 4 | 2 | 3 | 4 |
| Nº estantes Nº shelves Nº d'étagères | 2 | 3 | 4 | 2 | 3 | 4 | 2 | 3 | 4 |
| Sistema de frío Cooling System Système de froid | MONOBLOCK Forzado / Forced air / Ventilé | | | | | | | | |
| Desescarche Defrost Dégivrage | Parada compresor / Compressor off / Arrêt du compresseur | | | Gas caliente / Hot gas / Gaz chaud | | | Parada compresor / Compressor off / Arrêt du compresseur | | |
| Expansión Expansion Expansion | Capilar / Capillary / Capillaire | | | Válvula de expansión termostática / Thermostatic expansion valve / Valve d'expansion thermostatique | | | Capilar / Capillary / Capillaire | | |
| Potencia Power Puissance [W] | 255 | 410 | 605 | 694 | 723 | 264 | 269 | 429 | |
| Potencia frig. Cooling capacity Puissance Frig. [W A -10°C] | 370 | 690 | 445 | 540 | 370 | 690 | | | |
| Consumo Consumption Consommation [kWh/ 24h] | 2,04 | 2,37 | 2,40 | 4,02 | 6,57 | 6,78 | - | | |
| Clase energética Energy class Classe Énerg. | B | | | C | | | - | | |
| Refrigerante Refrigerant Gaz | R-290 | | | | | | | | |
| Opcional Optional Options | Parrilla / Wire shelf / Grille [502X07] | | | | | | 39 € | | |
| | 115V/1ph/60Hz 230V/1ph/60Hz Sin incremento / No increase / Sans supplément | | | 115V/1ph/60Hz 230V/1ph/60Hz + 3% Sin incremento / No increase / Sans supplément | | | 115V/1ph/60Hz 230V/1ph/60Hz Sin incremento / No increase / Sans supplément | | |
| | Kit 2 cajones / 2 Drawer Kit / Kit 2 tiroirs 1/2 x 200 [JCAJ17FM61/2] | | | | | | 372 € | | |

Serie / Series / Série **IM 600**

+Info: www.infrico.com

IM602PCR



Opcional Kit 2 cajones /
Optional 2 Drawer Kit /
Optional Kit 2 tiroirs
1/2 x 200 [JCAJ17FM61/2]

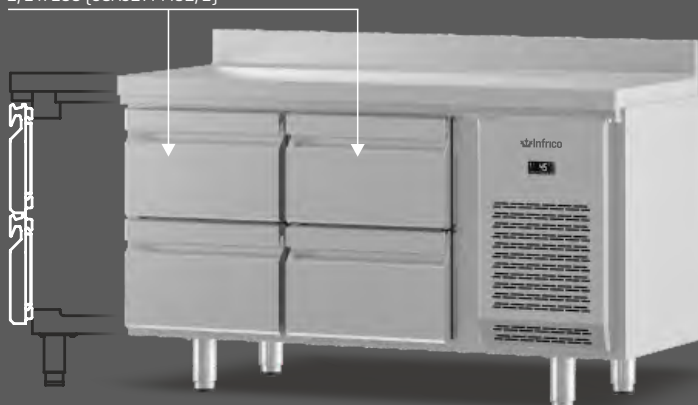

IM602P

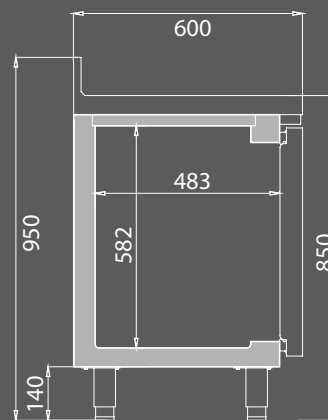

Controlador digital IP 65.
Digital control IP65
Contrôleur digital IP 65.









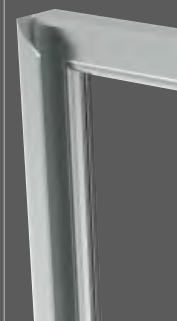

Circulación optimizada del aire
Optimal air flow
Circulation d'air optimisée

Sistema de ventilación de condensación frontal
Front breathing condensation system
Système de ventilation à condensation frontale

Tirador p. cristal
Glass door handle
Poignée p. vitrée



Mesas refrigeración, congelación y puertas de cristal GN1/1 / GN1/1 Refrigerated counters, freezers and glass doors / Dessertes positives, négatives et portes vitrées GN1/1

| MODELO MODELE MODÈLE |  |  |  |  |  |  |  |  |  |
|---|---|---|---|--|---|---|---|---|---|
| Precio Price Prix | 2.098 € | 2.456 € | 2.913 € | 2.746 € | 3.175 € | 3.704 € | 2.198 € | 2.671 € | 3.177 € |
| Medidas Measures [mm] Mesures | 1468 x 700 x 850 mm. | 1960 x 700 x 850 mm. | 2452 x 700 x 850 mm. | 1468 x 700 x 850 mm. | 1960 x 700 x 850 mm. | 2452 x 700 x 850 mm. | 1468 x 700 x 850 mm. | 1960 x 700 x 850 mm. | 2452 x 700 x 850 mm. |
| Temperatura Temperature Température [°C] | -2°C/+8°C | | | -18°C | | | +2°C/+6°C | | |
| Clase Climática Climatic class Classe climatique [°C] | 4 / 38°C | | | | | | | | |
| Tensión/Frecuencia Electrical data Tension électrique | 230V/1ph/50Hz | | | | | | | | |
| Controlador Controller Régulateur | Digital IP65 | | | | | | | | |
| Material Material [EXT/INT] Matériel | AISI 430 / Encimera-Worktop-Dessus AISI 304 | | | | | | | | |
| Espesor Thickness Épaisseur [mm] | 70 | | | | | | | | |
| Aislamiento Isolation Isolation [mm] | 40kg/m ³ / Free CFC's / Zero ODP-GWP | | | | | | | | |
| Capacidad Capacity Capacité [L] | 305 | 465 | 630 | 305 | 465 | 630 | 305 | 465 | 630 |
| Puertas Doors Portes | 2 | 3 | 4 | 2 | 3 | 4 | 2 | 3 | 4 |
| Nº estantes Nº shelves Nº d'étagères | 2 | 3 | 4 | 2 | 3 | 4 | 2 | 3 | 4 |
| Sistema de frío Cooling System Système de froid | MONOBLOCK Forzado / Forced air / Ventilé | | | | | | | | |
| Desescarche Defrost Dégivrage | Parada compresor / Compressor off / Arrêt du compresseur | | | Gas caliente / Hot gas / Gaz chaud | | | Parada compresor / Compressor off / Arrêt du compresseur | | |
| Expansión Expansion Expansion | Capilar / Capillary / Capillaire | | | Válvula de expansión termostática / Thermostatic expansion valve / Valve d'expansion thermostatique | | | Capilar / Capillary / Capillaire | | |
| Potencia Power Puissance [W] | 297 | 460 | | 645 | 735 | 880 | 300 | 474 | 479 |
| Potencia frig. Cooling capacity Puissance Frig. [W A -10°C] | 370 | 690 | | 445 | 540 | 640 | 370 | 690 | |
| Consumo Consumption Consommation [kWh/ 24h] | 1,97 | 2,26 | 2,61 | 5,54 | 7,79 | 9,03 | - | | |
| Clase energética Energy class Classe Énerg. | B | | | C | | D | | - | |
| Refrigerante Refrigerant Gaz | R-290 | | | | | | | | |
| Opcional Optional Options | Parrilla / Wire shelf / Grille 530x325 [502X12] Juego de guías / Slides / Jeu de Glissières [GUALO115550; GUALO215550] | | | | | | 45 € 38 € | | |
| | 115V/1ph/60Hz 230V/1ph/60Hz Sin incremento / No increase / Sans supplément | | | 115V/1ph/60Hz 230V/1ph/60Hz + 3% Sin incremento / No increase / Sans supplément | | | 115V/1ph/60Hz 230V/1ph/60Hz Sin incremento / No increase / Sans supplément | | |
| | Kit 2 cajones / 2 Drawer Kit / Kit 2 tiroirs 1/2 x 200 [JCAJ17FM71/2] | | | | | | 354 € | | |

Serie / Series / Série **IM 700**

+Info: www.infrico.com

IM703PN



Ventilación frontal
Front breathing
Ventilation frontale



Controlador digital IP 65.
Digital control IP65
Contrôleur digital IP 65.



Circulación optimizada del aire
Optimal air flow
Circulation d'air optimisée

Sistema de ventilación de condensación frontal
Front breathing condensation system
Système de ventilation à condensation frontale

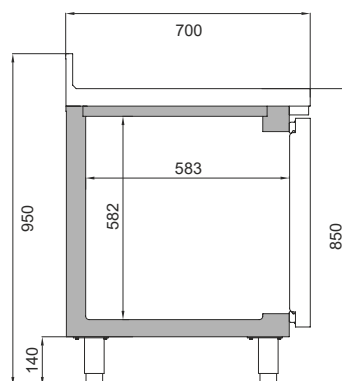

Tirador p. cristal
Glass door handle
Poignée p. vitrée



Opcional Kit 2 cajones /
Optional 2 Drawer Kit /
Optional Kit 2 tiroirs

Costado inyectado
Insulated side
Joue Isolée









IM702P

Puertas con doble acristalamiento (6-15-5)
Double glazed doors [6-15-5]
Portes double vitrage [6-15-5]



IM702PCR

Frente mostrador / Tall back bar counter / Dessertes arrière bar positives

| MODELO MODELE MODÈLE |  IF602P |  IF603P |  IF604P |  IF602PCR |  IF603PCR |  IF604PCR |
|---|---|--|--|--|--|--|
| Precio Price Prix | 2.137 € | 2.563 € | 3.028 € | 2.347 € | 2.853 € | 3.491 € |
| Medidas Measures [mm] Mesures | 1468 x 600 x 1050 mm. | 1960 x 600 x 1050 mm. | 2452 x 600 x 1050 mm. | 1468 x 600 x 1050 mm. | 1960 x 600 x 1050 mm. | 2452 x 600 x 1050 mm. |
| Temperatura Temperature Température | -2°C/+8°C | | | +2°C/+6°C | | |
| Clase Climática Climatic class Classe climatique | 4 / 38°C | | | | | |
| Tensión/Frecuencia Electrical data Tension électrique | 230V/1ph/50Hz | | | | | |
| Controlador Controller Régulateur | Digital IP65 | | | | | |
| Material Material [EXT/INT] Matériel | AISI 430 / Encimera-Worktop-Dessus AISI 304 | | | | | |
| Espesor Thickness Épaisseur | 70 | | | | | |
| Aislamiento Isolation Isolation | 40kg/m ³ / Free CFC's / Zero ODP-GWP | | | | | |
| Capacidad Capacity Capacité | 345 | 535 | 730 | 345 | 535 | 730 |
| Puertas Doors Portes | 2 | 3 | 4 | 2 | 3 | 4 |
| Nº estantes Nº shelves Nº d'étagères | 4 | 6 | 8 | 4 | 6 | 8 |
| Sistema de frío Cooling System Système de froid | MONOBLOCK Forzado / Forced air / Ventilé | | | | | |
| Desescarche Defrost Dégivrage | Parada compresor / Compressor off / Arrêt du compresseur | | | | | |
| Expansión Expansion Expansion | Capilar / Capillary / Capillaire | | | | | |
| Potencia Power Puissance | 264 | 435 | | 273 | 450 | 455 |
| Potencia frig. Cooling capacity Puissance Frig. | 370 | 690 | | 370 | 690 | 690 |
| Consumo Consumption Consommation | 2,04 | 2,40 | 2,73 | - | - | - |
| Clase energética Energy class Classe Énerg. | B | | | - | | |
| Refrigerante Refrigerant Gaz | R-290 | | | | | |
| Opcional Optional Options | Parrilla / Wire shelf / Grille 325x430 [502X07] 39 € 115V/1ph/60Hz Sin incremento / No increase / Sans supplément 230V/1ph/60Hz Sin incremento / No increase / Sans supplément | | | | | |
| | Tolva / Coffee-grounds hopper / Tiroir marc à café ou 1 tiroir neutre 40 € | | | | | |

IF603P



Suplemento Parrilla incluido
Supplement Wire Shelf including
 Supplément Grille inclus

Puertas con doble acristalamiento [6-15-5]
Double glazed doors [6-15-5]
 Portes double vitrage [6-15-5]



Controlador digital IP 65.
Digital control IP65.
 Contrôleur digital IP 65.



Tolva opcional
Optional coffee-grounds hopper
 Tiror marc à café ou 1 tiroir neutre



IF603PCR

Tirador p. cristal
Glass door handle
 Poignée p. vitrée

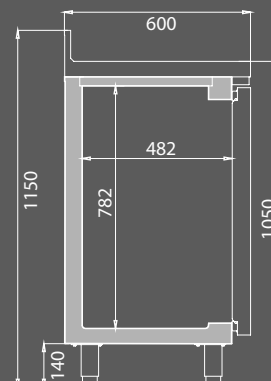
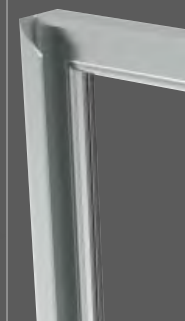







Mesas cafetera / Shelf unit / Meuble étagère (IEST)

MESA CAFETERA / COFFE UNIT / MEUBLE CAFÉTÉRIA

Mesas estantería / Coffee unit / Meuble cafétéria (IMC)

MESA ESTANTERÍA / SHELF UNIT / MEUBLE ÉTAGÈRE

| MODELO MODELE MODÈLE |  |  |  |  |  |  |
|---|---|---|---|--|---|---|
| | IMC100 | IMC150 | IMC200 | IEST100 | IEST150 | IEST200 |
| Precio Price Prix | 845 € | 1.000€ | 1.218 € | 633 € | 761 € | 921 € |
| Medidas Measures [mm] Mesures | 1000 x 600 x 1050 mm. | 1470 x 600 x 1050 mm. | 1960 x 600 x 1050 mm. | 1000 x 600 x 1050 mm. | 1470 x 600 x 1050 mm. | 1960 x 600 x 1050 mm. |
| Material Material Matériel | [EXT/INT] AISI 304 | | | | | |
| Puertas Doors Portes | 1 | 1 | 1 | - | - | - |
| Cajones / Tolva Drawers / Hopper Portes | 1/1 | 1/1 | 2/1 | - | - | - |
| Estantes Shelves Étagères | 1 | 1 | 1 | 1 | 1 | 1 |
| Opcional Optional Options | Estante adicional / Additional shelf / Étagère extra (IMC100) 90 € Estante adicional / Additional shelf / Étagère extra (IMC150) 107 € Estante adicional / Additional shelf / Étagère extra (IMC200) 123 € | | | Estante adicional / Additional shelf / Étagère extra (IEST100) 37 € Estante adicional / Additional shelf / Étagère extra (IEST150) 54 € Estante adicional / Additional shelf / Étagère extra (IEST200) 90 € | | |



IMC150



IEST150

Serie / Series / Série **IMC / IEST**

+Info: www.infrico.com







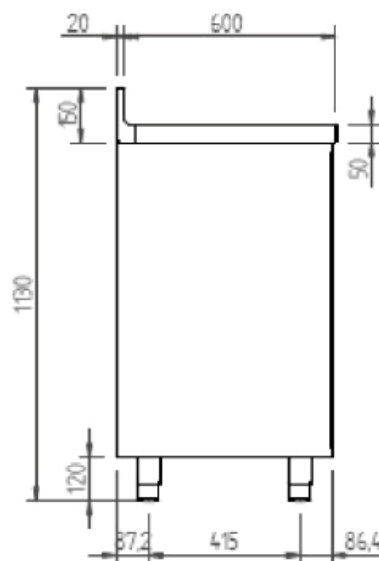

IMC200



IMC100



Armario refrigeración, congelación y puertas de cristal / Reach in refrigerators, freezers and glass door / Armoires positives, négatives et portes vitrées

| MODELO MODELE MODÈLE |  |  |  |  |  |  |  |  |
|---|---|---|---|---|---|---|---|---|
| Precio Price Prix | 2.075 € | 2.159 € | 2.806 € | 2.953 € | 2.541 € | 3.545 € | 2.314 € | 3.280 € |
| Medidas Measures [mm] Mesures | 687 x 712 x 2060 mm. | 687 x 712 x 2060 mm. | 1385 x 712 x 2060 mm. | 1385 x 712 x 2060 mm. | 687 x 712 x 2060 mm. | 1385 x 712 x 2060 mm. | 687 x 712 x 2060 mm. | 1387 x 712 x 2060 mm. |
| Temperatura Temperature Température | -2°C/+8°C | | | | -18°C | | +2°C/+6°C | |
| Clase Climática Climatic class Classe climatique | 4 / 38°C | | | | | | | |
| Tensión/Frecuencia Electrical data Tension électrique | 230V/1ph/50Hz | | | | | | | |
| Controlador Controller Régulateur | Digital IP65 | | | | | | | |
| Material Material [EXT/INT] Matériel | AISI 430 | | | | | | | |
| Espesor Thickness Épaisseur | 55 | | | | | | | |
| Aislamiento Isolation Isolation | 40kg/m ³ / Free CFC's / Zero ODP-GWP | | | | | | | |
| Capacidad Capacity Capacité | 490 | | 1070 | | 490 | 1070 | 490 | 1070 |
| Puertas Doors Portes | 1 | 2 | 2 | 4 | 1 | 2 | 1 | 2 |
| Nº estantes Nº shelves Nº d'étagères | 3 | | 6 | | 3 | 6 | 3 | 6 |
| Sistema de frío Cooling System Système de froid | Forzado / Forced air / Ventilé | | | | | | | |
| Desescarche Defrost Dégivrage | Parada compresor / Compressor off / Arrêt du compresseur | | | | Gas caliente / Hot gas / Gaz chaud | | Parada compresor / Compressor off / Arrêt du compresseur | |
| Expansión Expansion Expansion | Capilar / Capillary / Capillaire | | | | | | | |
| Potencia Power Puissance | 265 | | 435 | | 625 | 905 | 285 | 475 |
| Potencia frig. Cooling capacity Puissance Frig. | 370 | | 690 | | 540 | 720 | 370 | 690 |
| Consumo Consumption Consommation | 1,58 | | 3,04 | | 6,70 | 11,85 | - | - |
| Clase energética Energy class Classe Énerg. | C | | | | D | | - | |
| Refrigerante Refrigerant Gaz | R-290 | | | | | | | |
| Opcional Optional Options | Parrilla / Wire shelf / Grille [502X14] 52 € Ruedas / Casters / Roulettes [705X16=2; 705X17=2] 170 € 115V/1ph/60Hz Sin incremento / No increase / Sans supplément 230V/1ph/60Hz Sin incremento / No increase / Sans supplément | | | | | | | |

Serie / Series / Série **IAN 500/1000**

+Info: www.infrico.com

IAN1002 CR

Puerta con doble acristalamiento [6-15-5]
 Double glazed door [6-15-5]
 Portes double vitrage [6-15-5]

3 parrillas por puerta
 3 shelves per door
 3 grilles par porte

Tirador p. cristal
 Glass door handle
 Poignée p. vitrée

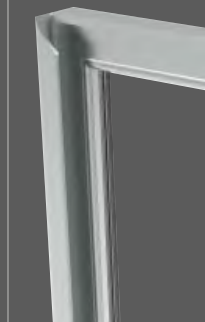

IAN501



IAN1002N

Controlador digital IP 65.
 Digital control IP65
 Contrôleur digital IP 65.

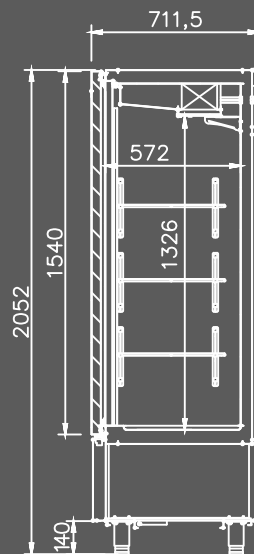

Armario refrigeración, congelación y puertas de cristal / Reach in refrigerators, freezers and glass door / Armoires positives, négatives et portes vitrées

| | REFRIG / REFRIG / POSIT | | CONGEL / FREEZ / NÉGAT | | REFRIG / REFRIG / POSIT | |
|---|--|-----------------------------|---|-----------------------------|--|-----------------------------|
| MODELO MODELE MODÈLE | IAG701 | IAG1402 | IAG701N | IAG1402N | IAG701CR | IAG1402CR |
| Precio Price Prix | 2.250 € | 3.174 € | 2.852 € | 3.962 € | 2.396 € | 3.498 € |
| Medidas Measures [mm] Mesures | 687 x 838 x 2060 mm. | 1387 x 838 x 2060 mm. | 687 x 838 x 2060 mm. | 1387 x 838 x 2060 mm. | 687 x 838 x 2060 mm. | 1387 x 838 x 2060 mm. |
| Temperatura Temperature Température | -2°C/+8°C | | -18°C | | +2°C/+6°C | |
| Clase Climática Climatic class Classe climatique | 4 / 38°C | | | | | |
| Tensión/Frecuencia Electrical data Tension électrique | 230V/1ph/50Hz | | | | | |
| Controlador Controller Régulateur | Digital IP65 | | | | | |
| Material Material [EXT/INT] Matériel | AISI 430 | | | | | |
| Espesor Thickness Épaisseur | 55 | | | | | |
| Aislamiento Isolation Isolation | 40kg/m ³ / Free CFC's / Zero ODP-GWP | | | | | |
| Capacidad Capacity Capacité | 580 | 1280 | 580 | 1280 | 580 | 1280 |
| Puertas Doors Portes | 1 | 2 | 1 | 2 | 1 | 2 |
| Nº estantes Nº shelves Nº d'étagères | 3 | 6 | 3 | 6 | 3 | 6 |
| Sistema de frío Cooling System Système de froid | Forzado / Forced air / Ventilé | | | | | |
| Desescarche Defrost Dégivrage | Parada compresor / Compressor off / Arrêt du compresseur | | Gas caliente / Hot gas / Gaz chaud | | Parada compresor / Compressor off / Arrêt du compresseur | |
| Expansión Expansion Expansion | Capilar / Capillary / Capillaire | | Válvula de expansión termostática / Thermostatic expansion valve / Valve d'expansion thermostatique | | Capilar / Capillary / Capillaire | |
| Potencia Power Puissance | 265 | 445 | 625 | 905 | 285 | 495 |
| Potencia frig. Cooling capacity Puissance Frig. | 370 | 690 | 540 | 720 | 370 | 690 |
| Consumo Consumption Consommation | 2,5 | 3,3 | 8,45 | 15,21 | - | - |
| Clase energética Energy class Classe Énerg. | D | C | C | D | - | - |
| Refrigerante Refrigerant Gaz | R-290 | | | | | |
| Opcional Optional Options | Parrilla / Wire shelf / Grille [530X650mm] [502X14] 57 € Juego de guías GD / Slides GD / Jeu de Glisières GD [GUIALO115641; GUIALO215641] 45 € Ruedas / Casters / Roulettes [705X16=2; 705X17=2] 170 € Juego de guías / Slides / Jeu de Glisières GN 2/1 650x450 [GUIAO1UAGB/GUIAO2UAGB] 87 € Juego de guías / Slides / Jeu de Glisières 600x400 [GUIALO1641P/GUIALO2641P] 75 € 115V/1ph/60Hz Sin incremento / No increase / Sans supplément 230V/1ph/60Hz Sin incremento / No increase / Sans supplément | | | | | |

Serie / Series / Série **IAG 700/1400**

+Info: www.infrico.com

IAG701

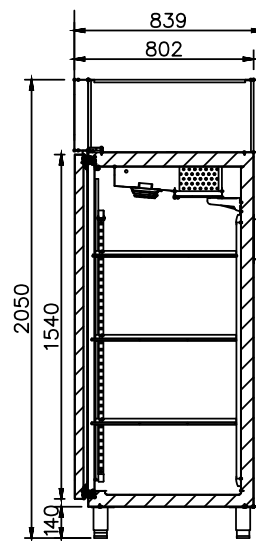

Controlador digital IP 65.
Digital control IP65
Contrôleur digital IP 65.



IAG1402CR

Puerta con doble acristalamiento (6-15-5)
Double glazed door (6-15-5)
Portes double vitrage (6-15-5)

OPCIONAL
OPTIONAL
OPTIONAL



GN 2/1 650x450



600x400

Tirador p. cristal
Glass door handle
Poignée p. vitrée



PHOTOBOOK





Línea Americana

American Line / Ligne Americaine

6





Serie / Series / Série

GN 2/1



AN
AN BT
AN MX

AN CR 182-183

Serie / Series / Série

UC



UC R/RCR/P

UC F

UC RW/RWCR/FW 184-191

Serie / Series / Série

UC PMT



UC P / PD

UC PMT 192-195

Serie / Series / Série

MR



MR

MR BT 196-197

Serie / Series / Série

MR / MR EN



MR

MR BT

MR EN 198-199

Serie / Series / Série

MR GT / MPG COMBO



MR GT COMBO

MPG COMBO 200-201

Serie / Series / Série

CHEF BASES



MSG 202-203

Serie / Series / Série

BACK BAR



ERV II SD

ERV II GD 204-205



6. Línea Americana

American Line / Ligne Americaine



SOPORTA HASTA
HOLDS UP TO
SUPPORTE JUSQU'À

450Kg

MSG 72, 96, 110



SOPORTA HASTA
HOLDS UP TO
SUPPORTE JUSQU'À

300Kg

MSG 36, 48, 52

Doble acristalamiento templado, bajo emisoro con carga de Argón (4-27-4).

Double tempered glass, low-e with argon charge (4-27-4).

Triple vitrage et verre trempé (4-12-3-12-4).

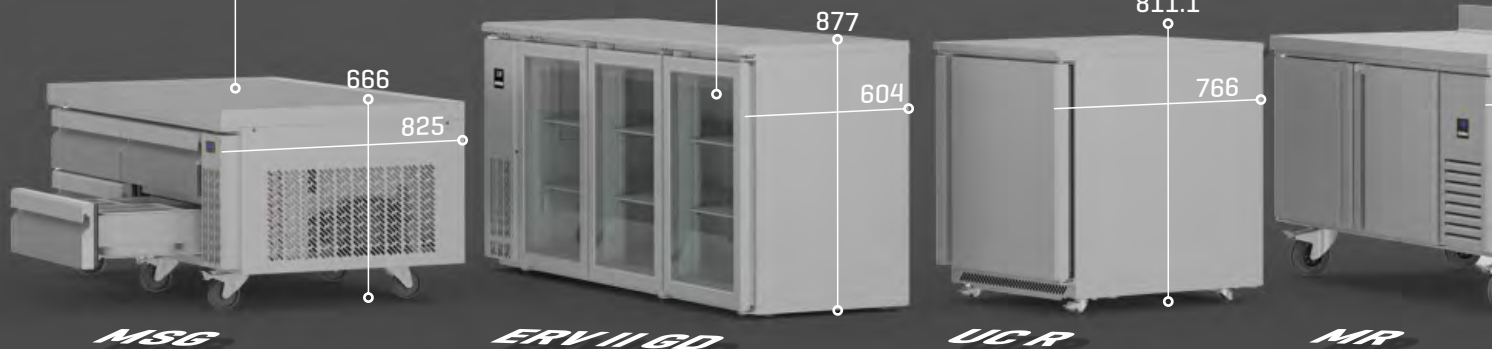

Iluminación / Lighting / Éclairage

Incorporación de iluminación LED, llegando a reducir el consumo energético entre un 80% y 90%, respecto a una bombilla tradicional. RGB opcional.

LED lighting incorporated, reducing energetic consumption between 80% and 90% respect to a traditional light bulb. RGB optional.

Éclairage LED, réduisant la consommation énergétique entre 80% et 90%, par rapport à une ampoule traditionnelle. RGB optionnel.



Tiradores ergonómicos.

Ergonomic handles.

Poignées ergonomiques.



Ruedas incluidas [excepto en ERV] /

Casters included [except ERV] /

Roues incluses [sauf ERV]



Armarios de refrigeración GN2/1 / GN2/1 Reach in refrigerator / Armoire positive GN2/1

REFRIG / REFRIG / POSIT

CONGEL / FREEZ / NÉGAT

MIXTO
DUAL TEMP.
MIXTE

REFRIG / REFRIG / POSIT

MODELO
MODELE
MODÈLE

AN 23

AN 49

AN 67

AN 23 BT

AN 49 BT

AN 67 BT

AN 49 MX

AN 23 CR

AN 49 CR

AN 67 CR

| Precio Price Prix | 2.554 € | 3.404 € | 4.434 € | 3.083 € | 4.103 € | 5.281 € | 4.800 € | 2.290 € | 4.324 € | 5.848 € |
|--|---|-----------------------------|-----------------------------|--|-----------------------------|-----------------------------|---|--|-----------------------------|-----------------------------|
| Medidas Measures Mesures (mm) | 687 x 796 x 2112 mm. | 1384 x 796 x 2112 mm. | 2081 x 796 x 2112 mm. | 687 x 796 x 2112 mm. | 1384 x 796 x 2112 mm. | 2081 x 796 x 2112 mm. | 1384 x 796 x 2112 mm. | 687 x 796 x 2112 mm. | 1384 x 796 x 2112 mm. | 2081 x 796 x 2112 mm. |
| Temperatura Temperature Température (°C) | -2°C/+8°C | | | -18°C | | | -2°C/+8°C -18°C | +2°C / +6°C | | |
| Clase Climática Climatic class Classe climatique (°C) | 5 / 40° C | | | 4 / 38° C | | | | | | |
| Tensión/Frecuencia Electrical data Tension électrique | 230V/1ph/50Hz | | | | | | | | | |
| Controlador Controller Régulateur | Digital | | | | | | | | | |
| Material Material Matériel (EXT/INT) | Ext/Int: AISI 430 | | | | | | | | | |
| Espesor Thickness Épaisseur (mm) | 55 | | | | | | | | | |
| Aislamiento Isolation Isolation (mm) | 40kg/m ³ / Free CFC's / Zero ODP-GWP | | | | | | | | | |
| Capacidad Capacity Capacité (L) | 610 | 1350 | 1886 | 610 | 1350 | 1886 | 610+610 | 610 | 1350 | 1886 |
| Puertas Doors Portes | 1 | 2 | 3 | 1 | 2 | 3 | 2 | 1 | 2 | 3 |
| Nº parrillas / Guías Nº shelves / Slides Nº de grillas / Glissière | 3/3 [650x530] | 6/6 [650x530] | 9/9 [650x530] | 3/3 [650x530] | 6/6 [650x530] | 9/9 [650x530] | 6/6 [650x530] | 4/4 [650x530] | 8/8 [650x530] | 12/12 [650x530] |
| Desescarche Defrost Dégivrage | Parada de compresor / Compresor off / Arrêt du compresseur | | | Gas caliente / Hot gas / Gaz chaud | | | Parada compresor / Gas cal / Compresor off / Hot gas / Arrêt compresor / Gaz chaud | Parada de compresor / Compresor off / Arrêt du compresseur | | |
| Expansión Expansion Expansion | Capilar / Capillary / Capillaire | | | Válvula termostática / Expansion valve / Détendeur thermostatique | | | Capilar (+) V. Exp (-) Cap (+) Exp. valve (-) Cap (+) V. d'exp (-) | Capilar / Capillary / Capillaire | | |
| Potencia Power Puissance (W) | 267 | 455 | 460 | 662 | 640 | 1362 | 1330 | 460 | 495 | 650 |
| Potencia frig. Cooling capacity Puissance Frig. (W A) [-10° / 30° C BT] | 343 | 690 | 690 | 639 | 742 | 1278 | 690/640 | 690 | 690 | 934 |
| Consumo Consumption Consommation (kWh/24h) | 1,50 | 1,93 | 3,40 | 6,86 | 10,16 | 16,08 | | - | | |
| Clase energética Energy class Classe Énerg. | B | A | B | C | D | C | | - | | |
| Refrigerante Refrigerant Gaz | R-290 | | | | | | | | | |
| Opcional Optional Options | 115V/1 ph/60 Hz 230V/1 ph/60 Hz Sin incremento / No increase / Sans supplément | | | 115V/1 ph/60 Hz 230V/1 ph/60 Hz +3 Sin incremento / No increase / Sans supplément | | | 115V/1 ph/60 Hz 230V/1 ph/60 Hz Sin incremento / No increase / Sans supplément | | | |
| | Juego de guías / Slides / Jeu de Glissières [GUIAANG0] 45€ | | | | | | Patas / Legs / Pieds [506X42] 28€ | | | |
| | Parrilla / Wire shelf / Grille [502X14] 58€ | | | | | | Parrilla reforzada / Reinforced wire shelf Grille renforcée [502x91] 79€ Led RGB (por puerta) / Led RGB (per door) LED RGB (par porte) 68€ | | | |

Serie / Series / Série **GN 2/1**

+Info: www.infrico.com

AN 67 CR



Doble acristalamiento 6-15-5
Double glass 6-15-5
Double vitrage 6-15-5



AN 49 BT



Cerradura incorporada
Included lock
Serrure de série



Rejilla inferior
Bottom grill side
Grille inférieure



Ruedas con freno delantero
Wheels with front brake
Roues avec frein avant

Led RGB Opcional
Led RGB Optional
Led RGB Options





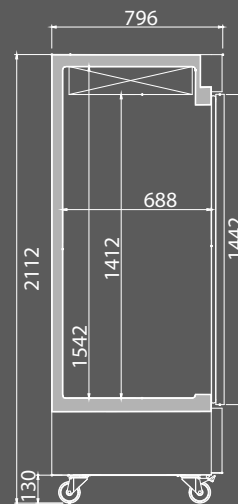
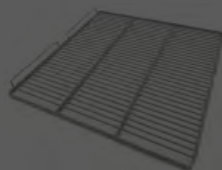



Parrilla reforzada
Reinforced wire shelf
Grille renforcée



Mesas undercounter de refrigeración / Undercounter refrigerators / Table undercounter positive

REFRIG / REFRIG / POSIT

REFRIG / REFRIG / POSIT

| MODELO MODELE MODÈLE |  |  |  |  |  |  | | |
|--|--|---|---|---|--|---|------------------------------|------------------------------|
| | UC 27 R CR | UC 36 R CR | UC 48 R CR | UC 60 R CR | UC 72 R CR | UC 27 2D | UC 48 4D | UC 60 4D |
| Precio Price Prix | R 1.755 € | 1.948 € | 2.311 € | 2.504 € | 2.854 € | 2.257 € | 3.296 € | 3.513 € |
| | R CR 2.066 € | 2.358 € | 2.961 € | 3.024 € | 3.557 € | | | |
| Medidas Measures Mesures | (mm) 702 x 766 x 811.1 mm. | 920 x 766 x 811.1 mm. | 1227 x 766 x 811.1 mm. | 1533 x 766 x 811.1 mm. | 1844 x 766 x 811.1 mm. | 702 x 766 x 811.1 mm. | 1227 x 766 x 811.1 mm. | 1533 x 766 x 811.1 mm. |
| Temperatura Temperature Temperature | [°C] -2°C/+8°C | | | | | | | |
| Clase Climática Climatic class Classe climatique | [°C] 4 / 38° C | | | | | | | |
| Tensión/Frecuencia Electrical data Tension électrique | 230V/1ph/50Hz | | | | | | | |
| Material Material Matériel | [EXT/INT] Ext/Int - Ext/Int - Ext/Int: AISI 430 Encimera / Worktop / Plan du travail: AISI 304 | | | | | | | |
| Espesor Thickness Épaisseur | [mm] 55 | | | | | | | |
| Capacidad Capacity Capacité | [L] 200 | 270 | 380 | 480 | 590 | 200 | 380 | 480 |
| Puertas/Cajones Doors/Drawers Tiroirs | 1 | 2 | | | 3 | 2 | 4 | |
| Nº parrillas J. guías Nº shelves / Slides Nº de grilles / Glissière | 2/2 [570x437] | 4/4 [380x437] | 4/4 [540x437] | 4/4 [693x437] | 6/6 [570x437] [540x437] | - | - | - |
| Desescarche Defrost Dégivrache | - | | | | | | | |
| Potencia Power Puissance | [W] 205 | | | 364 | | 205 | | |
| Potencia frig. Cooling capacity Puissance Frig. | [W A] [107 -30°C @1] 370 | | | 690 | | 370 | | |
| Consumo Consumption Consommation | [kWh/ 24h] 1,21 | 1,50 | 1,70 | 1,83 | 2,25 | 1,21 | 1,70 | 1,83 |
| Clase energética Energy class Classe Énerg. | A | | | | | A | | |
| Refrigerante Refrigerant Gaz | R-290 | | | | | | | |
| Opcional Optional Options | Parrilla / Wire shelf / Grille UC27 [502X73] 52 € | | | | | | | |
| | Parrilla / Wire shelf / Grille UC48 [502X74] 50 € | | | | | | | |
| Parrilla / Wire shelf / Grille UC60 [502X75] 61 € | | | | | | | | |
| Cerradura / Lock / Serrure [506X120; 506X121] 42 € | | | | | | | | |
| Patas / Legs / Pieds [506X42] 28 € | | | | | | | | |
| 115V/1ph/60Hz Sin incremento / No increase / Sans supplément | | | | | | | | |
| 230V/1ph/60Hz Sin incremento / No increase / Sans supplément | | | | | | | | |

Serie / Series / Série **UC R/RCR/D**

+Info: www.infrico.com



UC 72 R

Encimera acero inox AISI 304
AISI 304 stainless steel worktop
Plan de travail en AISI 304



UC 60 R CR

Sistema de ventilación frontal
Front breathing refrigeration system
Système de ventilation frontale



UC 60 4D

Cajones con guías telescópicas con salida mayorada y sistema de autocierre.
Drawers with telescopic guides for complete opening and self closing system.
Tiroirs avec glissières télescopiques avec ouverture facile et système de fermeture automatique.



UC 27 2D

Cajones no incluidos / Drawers not included / Tiroirs non inclus

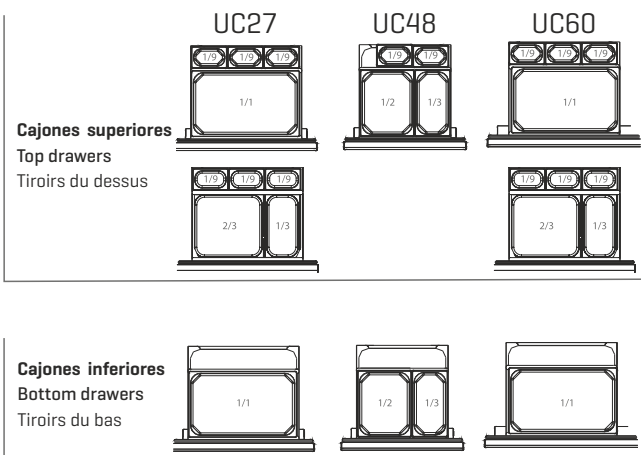

Cada cajón UC incluye una barra divisoria para las distintas configuraciones de bandejas. Hay otras barras disponibles en caso de cambio de la distribución.



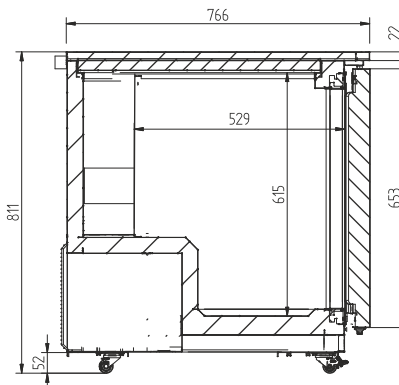

Each UC drawer includes one divider bar for different pan configurations. Other divider bars are available for varying size pan distribution.

Chaque tiroir UC comprend une barre de séparation pour différentes configurations de bacs. D'autres barres de séparation sont disponibles pour la répartition de bacs de taille variable.



Mesas undercounter de congelación / Undercounter freezers / Table undercounter négative

CONGEL / FREEZ / NÉGAT

| MODELO MODELE MODÈLE |  UC27F |  UC36F |  UC48F |  UC60F |
|--|---|---|---|---|
| Precio Price Prix | 2.300 € | 2.493 € | 2.840 € | 3.131 € |
| Medidas Measures Mesures (mm) | 702 x 766 x 811.1 mm. | 920 x 766 x 811.1 mm. | 1227 x 766 x 811.1 mm. | 1533 x 766 x 811.1 mm. |
| Temperatura Temperature Temperature (°C) | -18°C | | | |
| Clase Climática Climatic class Classe climatique (°C) | 4 / 38° C | | | |
| Tensión/Frecuencia Electrical data Tension électrique | 230V/1ph/50Hz | | | |
| Material Material (EXT/INT) Matériel | Ext/Int - Ext/Int - Ext/Int: AISI 430 Encimera / Worktop / Plan du travail: AISI 304 | | | |
| Espesor Thickness Épaisseur (mm) | 55 | | | |
| Capacidad Capacity Capacité (L) | 200 | 270 | 380 | 480 |
| Puertas/Cajones Doors/Drawers Tiroirs | 1 | 2 | | |
| Nº parrillas J. guías N° shelves / Slides N° de grilles / Glissière | 2/2 [570x437] | 4/4 [380x437] | 4/4 [540x437] | 6/6 [693x437] |
| Desescarche Defrost Dégivrache | - | | | |
| Potencia Power Puissance (W) | 408 | 457 | 507 | 637 |
| Potencia frig. Cooling capacity Puissance Frig. (W A) (-10° / -30° et) | 300 | | | |
| Consumo Consumption Consommation (kWh/ 24h) | 2,54 | 2,90 | 3,27 | 4,11 |
| Clase energética Energy class Classe Énerg. | A | | | |
| Refrigerante Refrigerant Gaz | R-290 | | | |
| Opcional Optional Options | Parrilla / Wire shelf / Grille UC27 [502X73] 52 € Parrilla / Wire shelf / Grille UC48 [502X74] 50 € Parrilla / Wire shelf / Grille UC60 [502X75] 61 € Cerradura / Lock / Serrure [506X120; 506X121] 42 € Patas / Legs / Pieds [506X42] 28 € 115V/1ph/60Hz +3% 230V/1ph/60Hz Sin incremento / No increase / Sans supplément | | | |

Serie / Series / Série **UC F**

+Info: www.infrico.com

UC 27 F

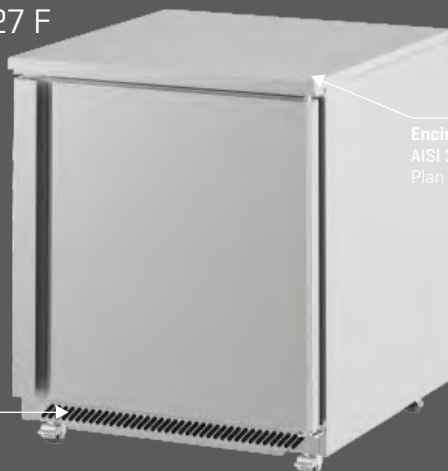

Encimera acero inox AISI 304
AISI 304 stainless steel worktop
Plan de travail en AISI 304

Sistema de ventilación frontal
Front breathing refrigeration system
Système de ventilation frontale

UC 48 F

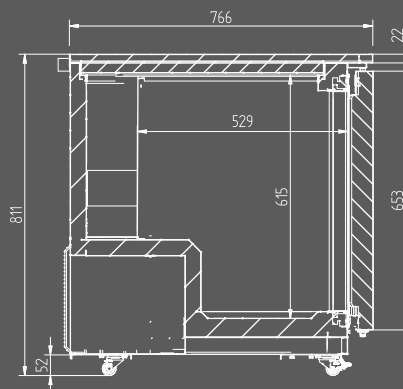



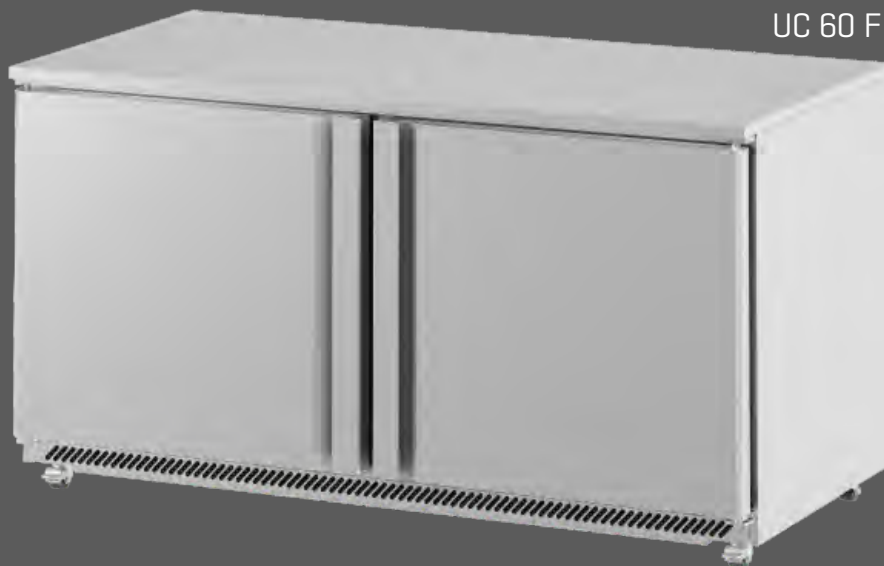

UC 60 F



Mesas Depth Worktop de refrigeración / Shallow Depth Worktop refrigerators / Table Depth Worktop positive

REFRIG / REFRIG / POSIT

| MODELO MODELE MODÈLE | |  |  |  |  |  |
|--|----------------------------|--|---|--|---|---|
| | | UC 27 RW UC 27 RW CR | UC 36 RW UC 36 RW CR | UC 48 RW UC 48 RW CR | UC 60 RW UC 60 RW CR | UC 72 RW UC 72 RW CR |
| Precio Price Prix | RW | 1.749 € | 1.985 € | 2.328 € | 2.510 € | 2.851 € |
| | RWCR | 2.043 € | 2.340 € | 2.785 € | 3.031 € | 3.555 € |
| Medidas Measures Mesures | (mm) | 702 x 766 x 1007 mm. | 920 x 766 x 1007 mm. | 1227 x 766 x 1007 mm. | 1533 x 766 x 1007 mm. | 1844 x 766 x 1007 mm. |
| Temperatura Temperature Temperature | (°C) | -2°C/+8°C | | | | |
| Clase Climática Climatic class Classe climatique | (°C) | 4 / 38° C | | | | |
| Tensión/Frecuencia Electrical data Tension électrique | | 230V/1ph/50Hz | | | | |
| Material Material Matériel | (EXT/INT) | Ext/Int - Ext/Int - Ext/Int: AISI 430 Encimera / Worktop / Plan du travail: AISI 304 | | | | |
| Espesor Thickness Épaisseur | (mm) | 55 | | | | |
| Capacidad Capacity Capacité | (L) | 200 | 270 | 380 | 480 | 590 |
| Puertas/Cajones Doors/Drawers Tiroirs | | 1 | 2 | | 3 | |
| Nº parrillas J. guías N° shelves / Slides N° de grilles / Glissière | | 2/2 (570x437) | 4/4 (380x437) | 4/4 (540x437) | 4/4 (693x437) | 6/6 (570x437) (540x437) |
| Desescarche Defrost Dégivrache | | - | | | | |
| Potencia Power Puissance | (W) | 205 | | | | 364 |
| Potencia frig. Cooling capacity Puissance Frig. | (W A) (-10° -30° aT) | 370 | | | | 690 |
| Consumo Consumption Consommation | (kWh/ 24h) | 1,21 | 1,50 | 1,70 | 1,83 | 2,25 |
| Clase energética Energy class Classe Énerg. | | A | | | | |
| Refrigerante Refrigerant Gaz | | R-290 | | | | |
| Opcional Optional Options | | Parrilla / Wire shelf / Grille UC27 [502X73] 52 € Parrilla / Wire shelf / Grille UC48 [502X74] 50 € Parrilla / Wire shelf / Grille UC60 [502X75] 61 € Cerradura / Lock / Serrure [506X120; 506X121] 42 € Patas / Legs / Pieds [506X42] 28 € 115V/1ph/60Hz Sin incremento / No increase / Sans supplément 230V/1ph/60Hz Sin incremento / No increase / Sans supplément | | | | |

Serie / Series / Série **UC RW/RWCR**

+Info: www.infrico.com

UC 48 RW CR

Encimera acero inox AISI 304
AISI 304 stainless steel worktop
Plan de travail en AISI 304



UC 27 RW

Sistema de ventilación frontal
Front breathing refrigeration system
Système de ventilation frontale

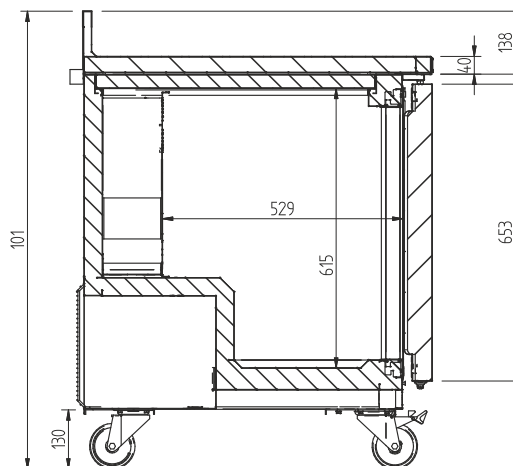





UC 72 RW CR



Mesas Depth Worktop de congelación / Shallow Depth Worktop freezers / Table Depth Worktop négative

CONGEL / FREEZ / NÉGAT

| MODELO MODELE MODÈLE |  UC 27 FW |  UC 36 FW |  UC 48 FW |  UC 60 FW |
|--|---|---|---|---|
| Precio Price Prix | 1.749 € | 1.948 € | 2.328 € | 2.510 € |
| Medidas Measures Mesures (mm) | 702 x 766 x 1007 mm. | 920 x 766 x 1007 mm. | 1227 x 766 x 1007 mm. | 1533 x 766 x 1007 mm. |
| Temperatura Temperature Temperature (°C) | -18°C | | | |
| Clase Climática Climatic class Classe climatique (°C) | 4 / 38° C | | | |
| Tensión/Frecuencia Electrical data Tension électrique | 230V/1ph/50Hz | | | |
| Material Material Matériel (EXT/INT) | Ext/Int - Ext/Int - Ext/Int: AISI 430 Encimera / Worktop / Plan du travail: AISI 304 | | | |
| Espesor Thickness Épaisseur (mm) | 55 | | | |
| Capacidad Capacity Capacité (L) | 200 | 270 | 380 | 480 |
| Puertas/Cajones Doors/Drawers Tiroirs | 1 | 2 | | 3 |
| Nº parrillas J. guías N° shelves / Slides N° de grilles / Glissière | 2/2 [570x437] | 4/4 [380x437] | 4/4 [540x437] | 6/6 [693x437] |
| Desescarche Defrost Dégivrache | - | | | |
| Potencia Power Puissance (W) | 408 | 457 | 507 | 637 |
| Potencia frig. Cooling capacity Puissance Frig. (W A) (-10° / -30° et) | 370 | | | |
| Consumo Consumption Consommation (kWh/ 24h) | 2,54 | 2,90 | 3,27 | 4,11 |
| Clase energética Energy class Classe Énerg. | A | | | |
| Refrigerante Refrigerant Gaz | R-290 | | | |
| Opcional Optional Options | Parrilla / Wire shelf / Grille UC27 [502X73] 52 € Parrilla / Wire shelf / Grille UC48 [502X74] 50 € Parrilla / Wire shelf / Grille UC60 [502X75] 61 € Cerradura / Lock / Serrure [506X120; 506X121] 42 € Patas / Legs / Pieds [506X42] 28 € 115V/1ph/60Hz +3% 230V/1ph/60Hz Sin incremento / No increase / Sans supplément | | | |

Serie / Series / Série **UC FW**

+Info: www.infrico.com

UC 48 FW



Sistema de ventilación frontal
Front breathing refrigeration system
Système de ventilation frontale

UC 27 FW

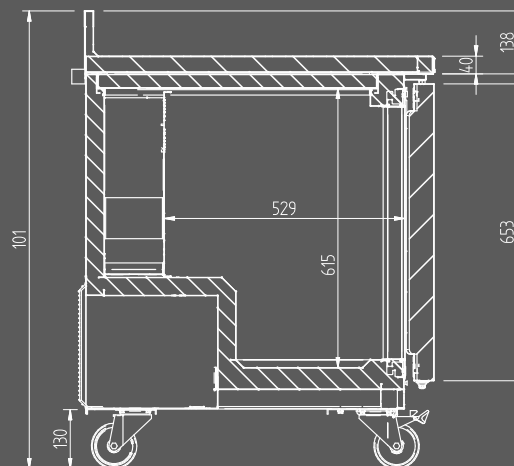

UC 60 FW



Encimera acero inox AISI 304
AISI 304 stainless steel worktop
Plan de travail en AISI 304









Mesas undercounter de refrigeración para ensaladas

Salads prep tables undercounters /

Table undercounter positive préparation salade

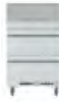
REFRIGERACIÓN / REFRIGERATOR / POSITIVE

| MODELO MODELE MODÈLE |  |  |  |  |  |  |  |  |
|--|---|---|---|---|--|---|---|---|
| | UC 27 P | UC 36 P | UC 48 P | UC 60 P | UC 72 P | UC 27 P 2D | UC 48 P 4D | UC 60 P 4D |
| Precio Price Prix | 2.066 € | 2.414 € | 2.762 € | 3.068 € | 3.528 € | 2.640 € | 4.129 € | 4.478 € |
| Medidas Measures Mesures [mm] | 702 x 766 x 1175 mm. | 920 x 766 x 1175 mm. | 1227 x 766 x 1175 mm. | 1533 x 766 x 1175 mm. | 1844 x 766 x 1175 mm. | 702 x 766 x 1175 mm. | 1227 x 766 x 1175 mm. | 1533 x 766 x 1175 mm. |
| Temperatura Temperature Temperature [°C] | 0°C/+6°C | | | | | | | |
| Clase Climática Climatic class Classe climatique [°C] | 4 / 38° C | | | | | | | |
| Tensión/Frecuencia Electrical data Tension électrique | 230V/1ph/50Hz | | | | | | | |
| Material Material [EXT/INT] Matériel | Ext/Int - Ext/Int - Ext/Int: AISI 430 Respaldo / Back / Arrière: Acero galvanizado / Galvanized steel / Acier galvanisée Encimera / Worktop / Plan du travail: AISI 304 | | | | | | | |
| Espesor Thickness Épaisseur [mm] | 55 | | | | | | | |
| Capacidad Capacity Capacité [L] | 200 | 270 | 380 | 480 | 590 | 200 | 380 | 480 |
| Puertas Doors Portes | 1 | 2 | | 3 | | 4 | | |
| Nº parrillas J. guías N° shelves / Slides N° de grilles / Glissière | 2/2 [570x437] | 4/4 [380x437] | 4/4 [540x437] | 4/4 [693x437] | 6/6 [570x437] [540x437] | - | | |
| Nº Bandejas N° Pans N° Containers | 8 | 8 | 12 | 16 | 18 | 6 | 12 | 16 |
| Evaporación Evaporation Evaporation | Ventilado / Ventilated / Ventilé | | | | | | | |
| Desescarche Defrost Dégivrache | - | | | | | | | |
| Potencia Power Puissance [W] | 205 | | 364 | | | 205 | | |
| Potencia frig. Cooling capacity Puissance Frig. [W A -10°C] | 370 | | 690 | | | 370 | | |
| Refrigerante Refrigerant Gaz | R-290 | | | | | | | |
| Opcional Optional Options | Tapa plana / Flat lid / Couvercle plat UC 27 P [TAPUC27PF] 89€ | | | | | Tapa plana / Flat lid / Couvercle plat UC 48 P [TAPUC48PF] 122 € | | |
| | Tapa plana / Flat lid / Couvercle plat UC 60 P [TAPUC60PF] 151 € | | | | | Tapa plana / Flat lid / Couvercle plat UC 72 P [TAPUC72PF] 170€ | | |
| | Patas / Legs / Pieds [506X42] 28 € | | | | | | | |
| | 115V/1ph/60Hz Sin incremento / No increase / Sans supplément | | | | | | | |
| | 230V/1ph/60Hz Sin incremento / No increase / Sans supplément | | | | | | | |

Serie / Series / Série **UC P**

+Info: www.infrico.com



UC 72 P

Espacio para estante
Shelf space
Espaces pour étagères



UC 48 P

Combinación de bandejas / Incluidas
Pans combinations / Included
Combinaison de bacs / Inclus

UC 27 P

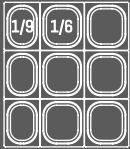

UC 48 P

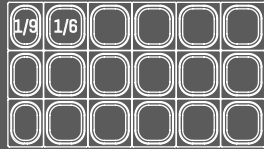

UC 60 P

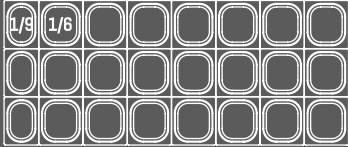

UC 72 P

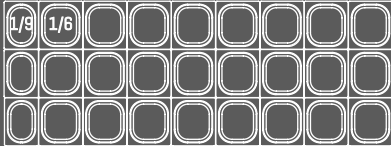

Tapa inyectada
Insulated top lid
Couvercle isolé



UC 60 P 4D

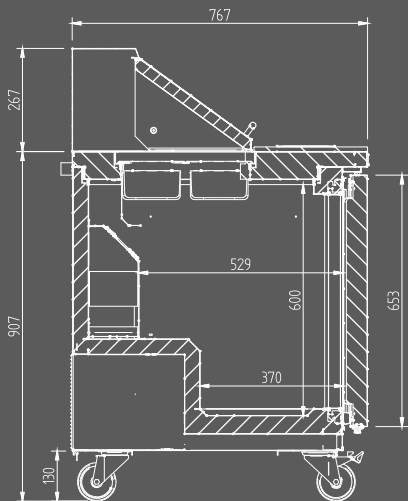

UC 27 P 2D







Tabla de corte
Cutting board
Table à découper



Mesas undercounter de refrigeración para ensaladas-sandwiches megatop / Salads-sandwiches megatop undercounter / Table undercounter positive préparation salades-sandwiches megatop

REFRIGERACIÓN / REFRIGERATOR / POSITIVE

| MODELO MODELE MODÈLE |  |  |  |  |  |
|--|---|---|--|---|---|
| | UC 27 PMT | UC 36 PMT | UC 48 PMT | UC 60 PMT | UC 72 PMT |
| Precio Price Prix | 2.209 € | 2.545 € | 2.881 € | 3.166 € | 3.722 € |
| Medidas Measures Mesures (mm) | 702 x 866 x 1246 mm. | 920 x 866 x 1246 mm. | 1227 x 866 x 1246 mm. | 1533 x 866 x 1246 mm. | 1844 x 866 x 1246 mm. |
| Temperatura Temperature Temperature (°C) | 0°C/+6°C | | | | |
| Clase Climática Climatic class Classe climatique (°C) | 4 / 38° C | | | | |
| Tensión/Frecuencia Electrical data Tension électrique | 230V/1ph/50Hz | | | | |
| Material Material Matériel (EXT/INT) | Ext/Int - Ext/Int - Ext/Int: AISI 430 Encimera / Worktop / Plan du travail: AISI 304 | | | | |
| Espesor Thickness Épaisseur (mm) | 55 | | | | |
| Capacidad Capacity Capacité (L) | 200 | 270 | 380 | 480 | 590 |
| Puertas Doors Portes | 1 | 2 | | 3 | |
| Nº parrillas J. guías Nº shelves / Slides Nº de grilles / Glissière | 2 [570x437] | 4 [380x437] | 4 [540x437] | 4 [693x437] | 6 [540x437] [570x437] |
| Nº Bandejas Nº Pans Nº Containers | 12 | 12 | 18 | 24 | 27 |
| Evaporación Evaporation Evaporation | Ventilado / Ventilated / Ventilé | | | | |
| Desescarche Defrost Dégivrache | - | | | | |
| Potencia Power Puissance (W) | 205 | | 364 | | |
| Potencia frig. Cooling capacity Puissance Frig. (W A -10°C) | 370 | | 690 | | |
| Refrigerante Refrigerant Gaz | R-290 | | | | |
| Opcional Optional Options | Tapa plana / Flat lid / Couvercle plat UC 27 PMT (TAPUC27PMTF) 101 € Tapa plana / Flat lid / Couvercle plat UC 48 PMT (TAPUC48PMTF) 149 € Tapa plana / Flat lid / Couvercle plat UC 60 PMT (TAPUC60PMTF) 162 € Tapa plana / Flat lid / Couvercle plat UC 72 PMT (TAPUC72PMTF) 183 € Patas / Legs / Pieds (506X42) 28 € 115V/1ph/60Hz Sin incremento / No increase / Sans supplément 230V/1ph/60Hz Sin incremento / No increase / Sans supplément | | | | |

Serie / Series / Série **UC PMT**

+Info: www.infrico.com

UC 72 PMT

Encimera de polietileno desmontable
Removable polyethylene worktop
Plan de travail amovible en polyéthylène

Espacio para estante
Shelf space
Espaces pour étagères



UC 27 PMT



Encimera de polietileno desmontable
Removable polyethylene worktop
Plan de travail amovible en polyéthylène

Sistema de ventilación frontal
Front breathing refrigeration system
Système de ventilation frontale

UC 60 PMT



Combinación de bandejas / Incluidas
Pans combinations / Included
Combinaison de bacs / Inclus

UC 27 PMT

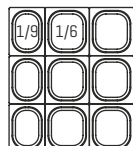

UC 48 PMT

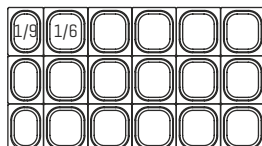

UC 60 PMT

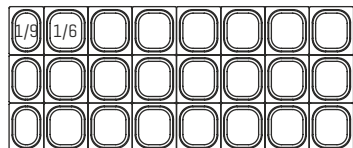



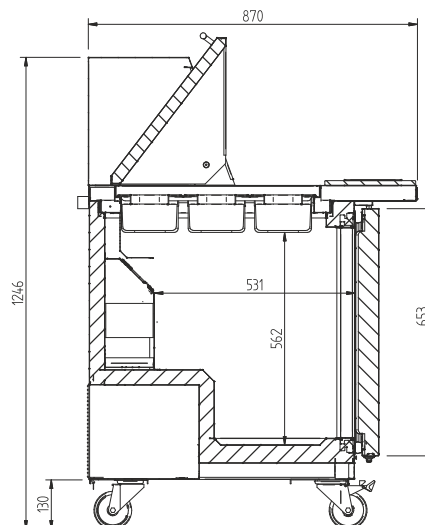
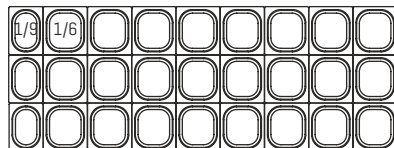

UC 72 PMT



Mesas Worktop de refrigeración y congelación / Worktop refrigerator and freezer / Table Worktop positive et négative

REFRIG / REFRIG / POSIT

CONGEL / FREEZ / NÉGAT

| MODELO MODELE MODÈLE |  MR 41 |  MR 67 |  MR 93 |  MR 41 BT |  MR 67 BT |
|---|---|---|--|--|--|
| Precio Price Prix | 2.420 € | 2.881 € | 3.551 € | 3.066 € | 3.518 € |
| Medidas Measures Mesures (mm) | 1050 x 830 x 1007 mm. | 1710 x 830 x 1007 mm. | 2370 x 830 x 1007 mm. | 1050 x 830 x 1007 mm. | 1710 x 830 x 1007 mm. |
| Temperatura Temperature Temperature (°C) | -2°C / +8°C | | | -18°C | |
| Clase Climática Climatic class Classe climatique (°C) | 5 / 40° C | | | | |
| Tensión/Frecuencia Electrical data Tension électrique | 230V/1ph/50Hz | | | | |
| Material Material Matériel (EXT/INT) | AISI 430 Encimera / Worktop / Dessus AISI 304 | | | | |
| Espesor Thickness Épaisseur (mm) | 55 | | | | |
| Capacidad Capacity Capacité | 220 | 480 | 765 | 220 | 480 |
| Puertas Doors Portes | 1 | 2 | 3 | 1 | 2 |
| Nº parrillas J. guías N° shelves / Slides N° de grilles / Glissière | 2 (510 x 650) | 4 (510 x 650) | 6 (510 x 650) | 2 (510 x 650) | 4 (510 x 650) |
| Nº Bandejas N° Pans N° Containers | - | | | | |
| Evaporación Evaporation Evaporation | Ventilado / Ventilated / Ventilé | | | | |
| Desescarche Defrost Dégivrache | Parada compresor / Compresor off / Arrêt compresseur. | | | Gas caliente / Hot gas / Gaz chaud | |
| Potencia Power Puissance (W) | 212 | 370 | | 458 | 678 |
| Potencia frig. Cooling capacity Puissance Frig. (-10°/30°C BT) (W A) | 370 | 690 | | 445 | 580 |
| Refrigerante Refrigerant Gaz | R-290 | | | | |
| Opcional Optional Options | Parrilla / Wire shelf / Grille (502X77) | | | 57 € | |
| | Patas / Legs / Pieds (506X42) | | | 28 € | |
| | Kit cajones / Drawer kit / Kit tiroirs (JCAJ10MR442C) | | | 651 € | |
| | Juego de Guías / Set of Sliders / Jeu de Glissières (GUIA503MR01: GUIA503MR02) | | | 45 € | |
| | 115V/1ph/60Hz | Sin incremento / No increase / Sans supplément | | 115V/1ph/60Hz | 3% |
| | 230V/1ph/60Hz | Sin incremento / No increase / Sans supplément | | 230V/1ph/60Hz | Sin incremento / No increase / Sans supplément |

Serie / Series / Série **MR**

+Info: www.infrico.com



MR 93

Cerradura de serie
Standard door lock
Serrure de série

Control digital protegido con desescarche
Protected digital control with defrost
Contrôleur digital protégé avec dégivrage



MR 67

Encimera acero inox AISI 304
AISI 304 Stainless steel worktop
Dessus acier inox AISI 304

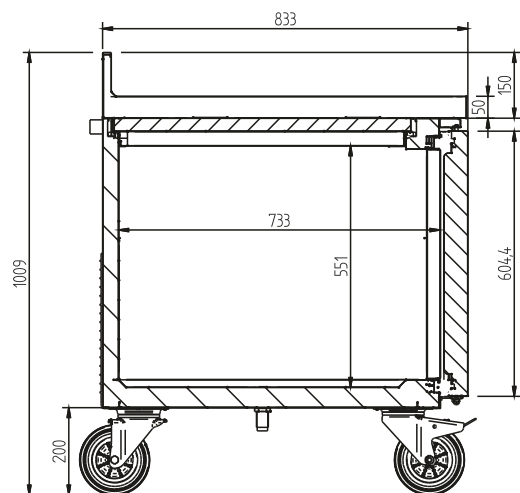

Kit cajones opcional
Optional drawers kit
Kit tiroirs en option

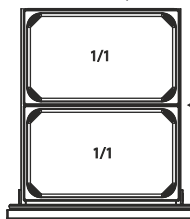

Barra divisoria opcional
Optional divider bar
Barre de division en option



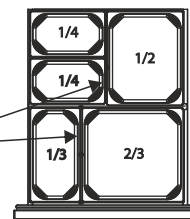

Cod: 10UC2749

Cod: 10UC27134



Mesas refrigeradas y pizzas / Pizza salad prep tables / Table positive prépr. salades et pizzas

REFRIGERACIÓN / REFRIGERATOR / POSITIVE

| MODELO MODELE MODÈLE |  |  |  |  |
|--|---|---|---|---|
| | MR 41 EN | MR 67 EN | MR 93 EN | MR 119 EN |
| Precio Price Prix | 2.799 € | 3.602 € | 4.298 € | 6.457 € |
| Medidas Measures Mesures (mm) | 1050 x 830 x 1106 mm. | 1710 x 830 x 1106 mm. | 2370 x 830 x 1106 mm. | 3030 x 830 x 1106 mm. |
| Temperatura Temperature Temperature (°C) | 0°C/+6°C | | | |
| Clase Climática Climatic class Classe climatique (°C) | 4 / 38° C | | | |
| Tensión/Frecuencia Electrical data Tension électrique | 230V/1ph/50Hz | | | |
| Material Material (EXT/INT) Matériel | Encimera / Worktop / Dessus AISI 304 | | | |
| Espesor Thickness Épaisseur (mm) | | | | |
| Capacidad Capacity Capacité (L) | 220 | 480 | 765 | 1050 |
| Puertas Doors Portes | 1 | 2 | 3 | 4 |
| Nº parrillas J. guías N° shelves / Slides N° de grilles / Glissière | 2 (510 x 650) | 4 (510 x 650) | 6 (510 x 650) | 8 (510x650) |
| Nº Bandejas N° Pans N° Containers | 5 | 9 | 13 | 16 |
| Evaporación Evaporation Évaporation | Ventilado / Ventilated / Ventilé | | | |
| Desescarche Defrost Dégivrache | Parada compresor / Compresor off / Arrêt compresseur. | | | |
| Potencia Power Puissance (W) | 370 | | 504 | |
| Potencia frig. Cooling capacity Puissance Frig. (W A) (-10°/30°C BT) | 690 | | 950 | |
| Refrigerante Refrigerant Gaz | R-290 | | | |
| Opcional Optional Options | Parrilla / Wire shelf / Grille [502X77] 57 € Patas / Legs / Pieds [506X42] 28 € Kit cajones / Drawer kit / Kit tiroirs [JCAJ10MR442C] 651 € Juego de Guías / Set of Sliders / Jeu de Glissières [GUIA503MR01: GUIA503MR02] 45 € 115V/1ph/60Hz Sin incremento / No increase / Sans supplément 230V/1ph/60Hz Sin incremento / No increase / Sans supplément | | | |

Serie / Series / Série **MR EN**

+Info: www.infrico.com

MR 93 EN

Encimera de polietileno desmontable
Removable polyethylene worktop
Plan de travail amovible en polyéthylène



MR 41 EN

Encimera de polietileno desmontable
Removable polyethylene worktop
Plan de travail amovible en polyéthylène



MR 67 EN

Cerradura de serie
Standard door lock
Serrure de série



Combinación de bandejas / Incluidas
Pans combinations / Included
Combinaison de bacs / Inclus

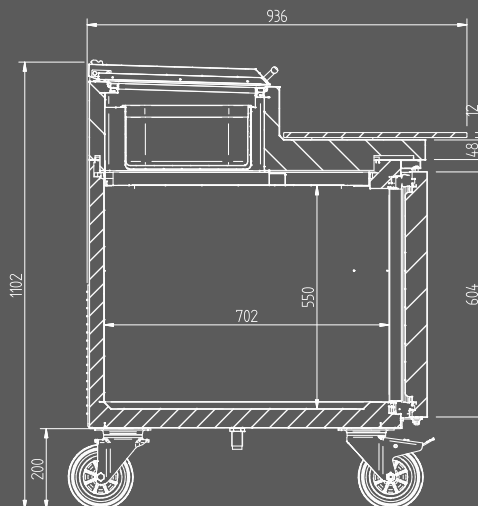

Mesas refrigerada pizzas / Pizza prep tables / Table positive préparation pizzas

REFRIGERACIÓN / REFRIGERATOR / POSITIVE

MODELO
MODELE
MODÈLE



MR 67 GT COMBO



MR 93 GT COMBO



MPG 1490 COMBO



MPG 1980 COMBO

| Precio Price Prix | 2.799 € | 3.691 € | 4.386 € | 6.600 € |
|---|--|-----------------------------|--|-----------------------------|
| Medidas Measures Mesures (mm) | 1751 x 830 x 1508 mm. | 2370 x 830 x 1508 mm. | 1499 x 700 x 1543 mm. | 1975 x 700 x 1543 mm. |
| Temperatura Temperature Temperature (°C) | 0°C/+6°C | | | |
| Clase Climática Climatic class Classe climatique (°C) | 4 / 38° C | | | |
| Tensión/Frecuencia Electrical data Tension électrique | 230V/1ph/50Hz | | | |
| Material Material (EXT/INT) Matériel | Encimera / Worktop / Dessus AISI 304 | | | |
| Espesor Thickness Épaisseur (mm) | 70 | | | |
| Capacidad Capacity Capacité (L) | 480 | 765 | 305 | 465 |
| Puertas Doors Portes | 2 | 3 | 2 | 3 |
| Nº parrillas J. guías N° shelves / Slides N° de grilles / Glissière | 4 (510 x 650) | 6 (510 x 650) | 2/10 (325 x 530) | 3/15 (325x530) |
| Nº Bandejas N° Pans N° Containers | 6 | 11 | 6 | 9 |
| Evaporación Evaporation Evaporation | Ventilado / Ventilated / Ventilé | | | |
| Desescarche Defrost Dégivrache | Parada compresor / Compresor off / Arrêt compresseur. | | | |
| Potencia Power Puissance (W) | 370 | | 369 | 553 |
| Potencia frig. Cooling capacity Puissance Frig. (W A) (-10°/30°C BT) | 690 + 170 | | 370+170 | 690+170 |
| Refrigerante Refrigerant Gaz | R-290 | | | |
| Opcional Optional Options | Parrilla / Wire shelf / Grille [502X77] | | 57 € | |
| | Patatas / Legs / Pieds [506X42] | | 28 € | |
| | Kit cajones / Drawer kit / Kit tiroirs [JCAJ10MR442C] | | 651 € | |
| | Juego de Guías / Set of Sliders / Jeu de Glissières [GUIA503MR01: GUIA503MR02] | | 45 € | |
| | 115V/1ph/60Hz | | Sin incremento / No increase / Sans supplément | |
| | 230V/1ph/60Hz | | Sin incremento / No increase / Sans supplément | |

Serie / Series / Série **GT COMBO / MPG COMBO**

+Info: www.infrico.com

MR67GTCOMBO



Encimera de granito
Granite worktop
Plan de travail à granite

MPG1980COMBO



Combinación de bandejas / Incluidas
Pans combinations / Included
Combinaison de bacs / Inclus

MPG1490 COMBO

[501X13] = 1 [501X11] = 4



MR67GT COMBO

[501X13] = 1 [501X11] = 5



MPG1980 COMBO

[501X11] = 8



MR93GT COMBO

[501X11] = 10

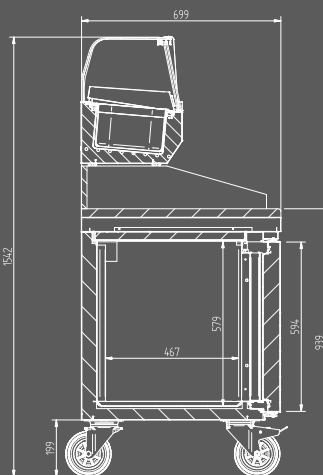

MPG COMBO

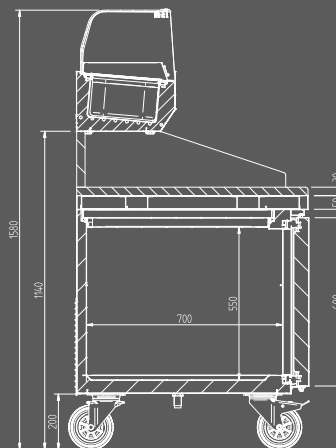







MR GT COMBO



Mesa baja refrigeración / Chef base refrigerator / Soubassement positif

REFRIGERACIÓN / REFRIGERATOR / POSITIVE

| MODELO MODELE MODÈLE |  |  |  |  |  |  |
|--|---|---|---|--|---|---|
| | MSG36 | MSG48 | MSG52 | MSG72 | MSG96 | MSG110 |
| Precio Price Prix | 3.010 € | 3.235 € | 3.487 € | 4.302 € | 4.808 € | 5.941 € |
| Medidas Measures Mesures (mm) | 930 x 825 x 666 mm. | 1235 x 825 x 666 mm. | 1352 x 825 x 666 mm. | 1845 x 825 x 666 mm. | 2464 x 825 x 666 mm. | 2809 x 825 x 666 mm. |
| Temperatura Temperature Temperature (°C) | 0°C/+6°C | | | | | |
| Clase Climática Climatic class Classe climatique (°C) | 4 / 38° C | | | | | |
| Tensión/Frecuencia Electrical data Tension électrique | 230V/1ph/50Hz | | | | | |
| Material Material Matériel (EXT/INT) | Ext/Int AISI 430 Encimera / Worktop / Dessus AISI 304 | | | | | |
| Espesor Thickness Épaisseur (mm) | 55 | | | | | |
| Capacidad Capacity Capacité (L) | 148 | 193 | 280 | 405 | 584 | 620 |
| Cajones Drawers Tiroirs | 2 | | 4 | | 6 | |
| Nº parrillas J. guías N° shelves / Slides N° de grilles / Glissière | 4 | | 6 | 8 | 12 | |
| Nº Bandejas N° Pans N° Containers | 2 GN1/1 + GN1/6 | | GN1/1 | | | |
| Evaporación Evaporation Evaporation | Ventilado / Ventilated / Ventilé | | | | | |
| Desescarche Defrost Dégivrache | Parada de compresor / Compressor off / Arrêt du compresseur | | | | | |
| Potencia Power Puissance (W) | 440 | | | 480 | 640 | |
| Potencia frig. Cooling capacity Puissance Frig. (W A -10°C) | 370 | | | | 690 | |
| Refrigerante Refrigerant Gaz | R-290 | | | | | |
| Opcional Optional Options | Patas / Legs / Pieds [506X42] 28 € 115V/1ph/60Hz Sin incremento / No increase / Sans supplément 230V/1ph/60Hz Sin incremento / No increase / Sans supplément | | | | | |

Serie / Series / Série **CHEF-BASES**

+Info: www.infrico.com

MSG96



Encimera acero inox AISI 304 con reborde de protección

AISI 304 Stainless steel worktop with protective flange

Dessus acier inox AISI 304 avec bride de protection



Marine Edge

MSG52

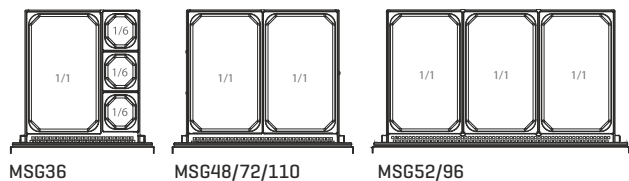

MSG36

MSG48/72/110

MSG52/96

Barra divisoria en opción
Optional divider bar
Barre de division en option

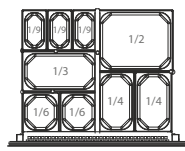

Cada cajón UC incluye una barra divisoria para las distintas configuraciones de bandejas. Hay otras barras disponibles en caso de cambio de la distribución.

Each UC drawer includes one divider bar for different pan configurations. Other divider bars are available for varying size pan distribution.

Chaque tiroir UC comprend une barres de séparation pour différentes configurations de bacs. D'autres barres de séparations sont disponibles pour la répartition de bacs de taille variable.

Encimera embutida con filo en V
Stamped worktop with "V" edge
Plan de travail embouti en "V"



SOPORTA HASTA
HOLDS UP TO
SUPPORTE JUSQU'À
450Kg
MSG 72, 96, 110







SOPORTA HASTA
HOLDS UP TO
SUPPORTE JUSQU'À
300Kg
MSG 36, 48, 52



Guías telescópicas, hasta 200 kg.
Drawers with telescopic guides up to 200 Kg.
Glissières d'auto fermeture telescopique qui peuvent supporter jusqu'à 200 Kg.

Frente mostrador refrigerado / Back bar coolers / Arrière bar

REFRIGERACIÓN / REFRIGERATOR / POSITIF

| MODELO MODELE MODÈLE |  |  |  |  |  |  |
|--|---|---|---|--|---|---|
| | ERV36IISD | ERV60IISD | ERV84IISD | ERV36IIGD | ERV60IIGD | ERV84IIGD |
| Precio Price Prix | 1.769 € | 2.194 € | 2.594 € | 1.953 € | 2.549 € | 3.100 € |
| Medidas Measures Mesures [mm] | 922 x 604 x 877 mm. | 1543 x 604 x 877 mm. | 2164 x 604 x 877 mm. | 922 x 604 x 877 mm. | 1543 x 604 x 877 mm. | 2164 x 604 x 877 mm. |
| Temperatura Temperature Température [°C] | -2°C/+8°C | | | 2°C/+6°C | | |
| Clase Climática Climatic class Classe climatique [°C] | 4 / 38° C | | | | | |
| Tensión/Frecuencia Electrical data Tension électrique | 230V/1ph/50Hz | | | | | |
| Material Material [EXT/INT] Matériel | Ext/Int AISI 430 | | | | | |
| Espesor Thickness Épaisseur [mm] | 55 | | | | | |
| Capacidad Capacity Capacité [L] | 162 | 362 | 562 | 162 | 362 | 562 |
| Puertas Doors Portes | 1 | 2 | 3 | 1 | 2 | 3 |
| Nº parrillas J. guías Nº shelves / Slides Nº de grilles / Glissière | 2 [487x465] | 4 [487x465] [610x465] | 6 [487x465] | 2 [487x465] | 4 [487x465] [610x465] | 6 [487x465] |
| Desescarche Defrost Dégivrache | Parada de compresor / Compressor off / Arrêt du compresseur | | | | | |
| Potencia Power Puissance [W] | 215 | 235 | 395 | 225 | 265 | 435 |
| Potencia frig. Cooling capacity Puissance Frig. [W A -10°C] | 370 | | 690 | 370 | | 690 |
| Consumo Consumption Consommation [kWh/ 24h] | 1,85 | 2,75 | 3,70 | - | | |
| Clase energética Energy class Classe Énerg. | B | C | C | - | | |
| Refrigerante Refrigerant Gaz | R-290 | | | | | |
| Opcional Optional Options | Iluminación Led RGB con cambio de color (por puerta) / Led lighting RGB change of colour (per door) / LED RGB avec changement de couleur (par porte) 68 € 115V/1ph/60Hz Sin incremento / No increase / Sans supplément 230V/1ph/60Hz Sin incremento / No increase / Sans supplément | | | | | |

Serie / Series / Série **BACK BAR**

+Info: www.infrico.com

ERV84IIGD



Grifo no disponible
Beer tap not available
Pompe et futs non disponibles

Cerradura de serie
Serial Lock
Serrure de série



ERV36IIGD



Tirador p. cristal
Glass door handle
Poignée p. vitrée

Control digital protegido con desescarche
Protected digital control with defrost
Contrôleur digital protégé avec dégivrage



Cavas & Dry Aging

7





Serie / Series / Série

AN SC



AN SC 212-213

Serie / Series / Série

AGB MDA



AGB MDA
AGB MDAB 214-215

Serie / Series / Série

VC MDA



VC MDA
VC MDAB 216-217

Serie / Series / Série

AC MDAB



AC MDAB 218-219

Serie / Series / Série

AMC



AMC L
AMC XL 220-221

Serie / Series / Série

VITRA V



LO V 224-225

Serie / Series / Série

EVV/VINTAGE MODULAR



EVV
EVV MX
EVV RG 226-227



228-229

Infrico



7. Cavas & Dry Aging

Doble acristalamiento templado, bajo emisor con carga de Argón [4-27-4].

Double tempered glass, low-e with argon charge [4-27-4].

Triple vitrage et verre trempé [4-12-3-12-4].



Control electrónico de Temperatura y Humedad.

Electronic Temperature and Humidity control.

Contrôle électronique de la Température et de l'Humidité.



Iluminación / Lighting / Éclairage

Incorporación de iluminación LED, llegando a reducir el consumo energético entre un 80% y 90%, respecto a una bombilla tradicional. RGB opcional.

LED lighting incorporated, reducing energetic consumption between 80% and 90% respect to a traditional light bulb. RGB optional.

Éclairage LED, réduisant la consommation énergétique entre 80% et 90%, par rapport à une ampoule traditionnelle. RGB optionnel.



Barra carnicera.

Meat bar set.

Barre à viande.



Modelos MDA en inox AISI304 y MDAB en acero lacado negro.

Models MDA in AISI304 stainless steel and MDAB in black lacquered steel.

Modèles MDA en inox AISI304 et MDAB en acier laqué noir.

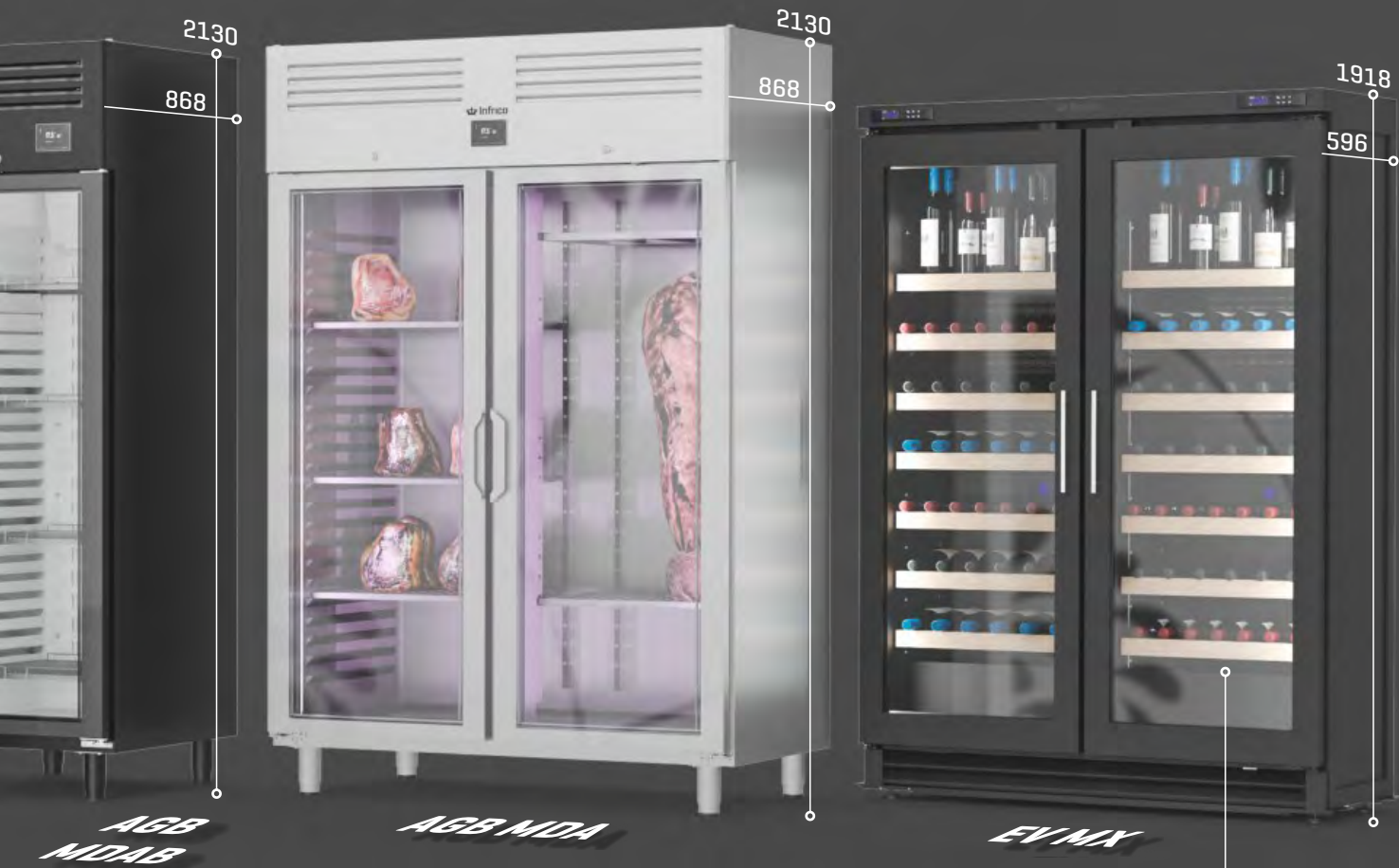

Parrillas / Grills / Grilles

Parrillas de acero lacado y madera.

Painted steels and wood grills.

Grilles en acier et en bois.

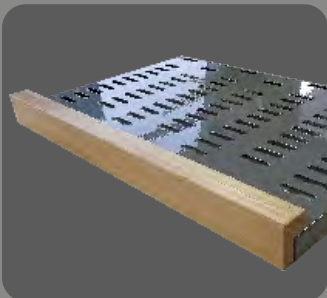

Opcional: parrillas de madera.

Optional: wood grills.

En option: Grilles en bois

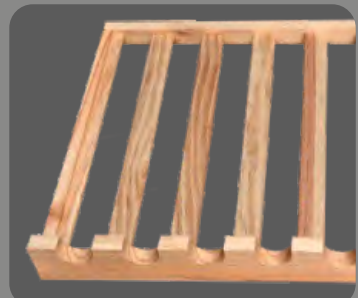

Armario secadero embutidos / Seasoning refrigerator / Armoire séchage affinage

SECADERO / SEASONING / SÉCHAGE



AN501 SC



AN1002 SC

| MODELO MODELE MODÈLE | AN501 SC | AN1002 SC |
|---|---|-----------------------------|
| Precio Price Prix | 3.421 € | 5.057 € |
| Medidas Measures [mm] Mesures | 687 x 700 x 2060 mm. | 1385 x 700 x 2060 mm. |
| Temperatura Temperature Température | +4°C/+16°C | |
| Clase Climática Climatic class Classe climatique | 4 / 38°C | |
| Tensión/Frecuencia Electrical data Tension électrique | 230V/1ph/50Hz | |
| Controlador Controller Régulateur | Digital IP65 | |
| Material Material [EXT/INT] Matériel | AISI 304 | |
| Espesor Thickness Épaisseur | 55 | |
| Aislamiento Isolation Isolation | 40kg/m ³ / Free CFC's / Zero ODP-GWP | |
| Capacidad Capacity Capacité | 500 | 1110 |
| Puertas Doors Portes | 1 | 2 |
| Nº parrillas / Guías Nº shelves / Slides Nº de grilles / Glissière | - | - |
| Barra carnicera Bars for meat set Nº bars à viande | 3 | 6 |
| Sistema de frío Cooling System Système de froid | Forzado / Forced air / Ventilé | |
| Desescarche Defrost Dégivrage | Parada de compresor / Compresor off / Arrêt du compresseur | |
| Expansión Expansion Expansion | Capilar / Capillary / Capillaire | |
| Potencia Power Puissance | 750 | 915 |
| Potencia frig. Cooling capacity Puissance Frig. | 370 | 690 |
| Consumo Consumption Consommation | - | - |
| Refrigerante Refrigerant Gaz | R-290 | |
| Opcional Optional Options | <p>Juego de guías / Slides AN 500 [GUIAC0315470] 38 €</p> <p>Juego de guías / Slides AN 1000 [GUIAC0115520; GUIAC0215520] 38 €</p> <p>115V/1ph/60Hz sin incremento / without supplement / sans supplément</p> <p>230V/1ph/60Hz sin incremento / without supplement / sans supplément</p> <p>Puerta de cristal / Glass door / Porte vitrée [PUE17DGAEX-PUE17IGAEX] 397 €</p> <p>Cerradura / Lock / Serrure [506X209; 506X210] 44 €</p> <p>Barra carnicera / Meat bar set / Barre à viande [BCSEC3] [BCSEC4] 201 €</p> | |

Serie / Series / Série AN 500/1000L

+Info: www.infrico.com

AN 1002 SC



Video del producto
Product Video
Vidéo du produit



Infrico Youtube

Control electrónico de Temperatura y Humedad
Electronic Temperature and Humidity control
Contrôle électronique de la Température et de l'humidité



25 Kg por puerta
25 Kg per door
25 Kg par porte



BCSEC3

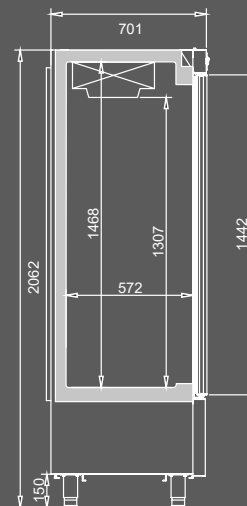

Armario madurador Dry Aging / Dry Aging meat cabinet / Armoire maduration Dry Aging



AGB701MDA



AGB1402MDA



AGB701MDA B



AGB1402MDA B

| MODELO MODELE MODÈLE | AGB701MDA | AGB1402MDA | AGB701MDA B | AGB1402MDA B |
|--|---|--|--|--|
| Precio Price Prix | 4.031 € | 6.476 € | 4.473 € | 6.981 € |
| Medidas Measures [mm] Mesures | 687 x 868 x 2130 mm. | 1385 x 868 x 2130 mm. | 687 x 868 x 2130 mm. | 1385 x 868 x 2130 mm. |
| Temperatura Temperature Température | T° 0°C/+16°C | | | |
| Clase Climática Climatic class Classe climatique | Humedad / humidity / humidité 45% HR / 85% HR | | | |
| Tensión/Frecuencia Electrical data Tension électrique | 4 / 38°C | | | |
| Controlador Controller Régulateur | 230V/1ph/50Hz | | | |
| Material Material [EXT/INT] Matériel | AISI 304 | | Int: AISI 304 Ext: Acero Lacado Negro / Black Lacquered Steel / Acier Laqué Noir | |
| Espesor Thickness Épaisseur | 75 | | | |
| Aislamiento Isolation Isolation | 40kg/m ³ / Free CFC's / Zero ODP-GWP | | | |
| Capacidad Capacity Capacité | 560 | 1240 | 560 | 1240 |
| Puertas Doors Portes | 1 | 2 | 1 | 2 |
| N° parrillas / Guías N° shelves / Slides N° de grilles / Glissière | 1 barra / meat bar / barre à viande 2 estantes / shelves / étagères | 2 barra / meat bar / barre à viande 4 estantes / shelves / étagères | 1 barra / meat bar / barre à viande 2 estantes / shelves / étagères | 2 barra / meat bar / barre à viande 4 estantes / shelves / étagères |
| Sistema de frío Cooling System Système de froid | Forzado / Forced air / Ventilé | | | |
| Desescarche Defrost Dégivrage | Parada de compresor / Compresor off / Arrêt du compresseur | | | |
| Expansión Expansion Expansion | Capilar / Capillary / Capillaire | | | |
| Potencia Power Puissance | 870 | 1380 | 870 | 1380 |
| Potencia frig. Cooling capacity Puissance Frig. | 370 | 690 | 370 | 690 |
| Consumo Consumption Consommation | 6,35 | 7,34 | 6,35 | 7,34 |
| Clase energética Energy class Classe Énerg. | - | | | |
| Refrigerante Refrigerant Gaz | R-290 | | | |
| Opcional Optional Options | Manejo control digital bluetooth o wifi / Operating digital control bluetooth or wifi / Trait. de contrôle digital bluetooth ou wifi | | | 143 € |
| | Ruedas / Casters / Roulettes [705X16=2; 705X17=2] | | | 161 € |
| | Barra carnícera / Meat bar set / Barre à viande [BCAN] | | | 182 € |
| | Esterilizador UVC + Ozono / UVC + Ozone Steriliser / Stérilisateur UVC + Ozone | | | 908 € |
| | Estantes adicionales / Additional shelves / Étagères supplémentaires | | | 71 € |
| | 115V/1ph/60Hz | sin incremento / without supplement / sans supplément | | |
| | 230V/1ph/60Hz | sin incremento / without supplement / sans supplément | | |

Serie / Series / Série **AGB MDA**

+Info: www.infrico.com

AGB1402MDA



Video del producto

Product Video

Vidéo du produit



Infrico Youtube



Led de serie con tonalidad especial para carne.
Standard LEDs with a special meat tone.
LEDs standard avec une tonalité spéciale viande.



AGB701MDAB

Controlador digital con control de temperatura, humedad y teclado táctil.
Digital controller with temperature, humidity control and touch keyboard.
Contrôleur digital tactile, avec contrôle de la température et de l'humidité.

Control electrónico de Temperatura y Humedad
Electronic Temperature and Humidity control
Contrôle électronique de la Température et de l'humidité

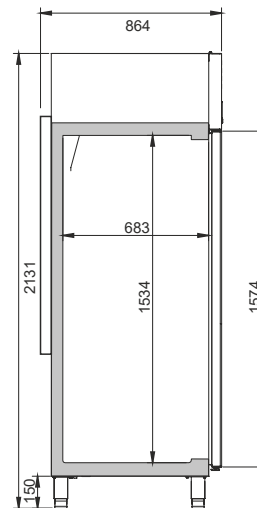

Vitrina de maduración Dry Aging / Dry Aging meat display case / Vitrine maduration Dry Aging



VC 1400 MDA



VC 1400 MDAB



VC 2010 MDA



VC 2010 MDAB

| MODELO MODELE MODÈLE | VC 1400 MDA | VC 1400 MDAB | VC 2010 MDA | VC 2010 MDAB |
|--|---|---|-----------------------------|---|
| Precio Price Prix | 4.441 € | 4.862 € | 5.545 € | 6.146 € |
| Medidas Measures [mm] Mesures | 1384 x 740 x 1060 mm. | 1384 x 740 x 1060 mm. | 2100 x 740 x 1060 mm. | 2100 x 740 x 1060 mm. |
| Temperatura Temperature Température | +0°C/+16°C | | | |
| Clase Climática Climatic class Classe climatique | Humedad / humidity / humidité 45% HR / 85% HR | | | |
| Tensión/Frecuencia Electrical data Tension électrique | 4 / 38°C | | | |
| Controlador Controller Régulateur | 230V/1ph/50Hz | | | |
| Material Material [EXT/INT] Matériel | AISI 304 | Int + tapa/lid/couvercle: AISI 304 Ext: Acero Lacado Negro / Black Lacquered Steel / Acier Laqué Noir | AISI 304 | Int + tapa/lid/couvercle: AISI 304 Ext: Acero Lacado Negro / Black Lacquered Steel / Acier Laqué Noir |
| Espesor Thickness Épaisseur | Digital IP65 | | | |
| Aislamiento Isolation Isolation | 70 | | | |
| Capacidad Capacity Capacité | 40kg/m ³ / Free CFC's / Zero ODP-GWP | | | |
| Puertas Doors Portes | 470 | 470 | 710 | 710 |
| Nº Estantes Shelves Nº Étagères | 1 | 1 | 1 | 1 |
| Barra carnicera Bars for meat set Nº bars à viande | 4 | 4 | 6 | 6 |
| Sistema de frío Cooling System Système de froid | - | - | - | - |
| Desescarche Defrost Dégivrage | Forzado / Forced air / Ventilé | | | |
| Expansión Expansion Expansion | Parada de compresor / Compresor off / Arrêt du compresseur | | | |
| Potencia Power Puissance | Capilar / Capillary / Capillaire | | | |
| Potencia frig. Cooling capacity Puissance Frig. | 551 | 551 | 557 | 557 |
| Consumo Consumption Consommation | 687 | 687 | 687 | 687 |
| Refrigerante Refrigerant Gaz | - | | | |
| Opcional Optional Options | <p style="text-align: center;">R-290</p> <p style="text-align: center;">Puerta de cristal (Dcha.-Right-Droite) KPUIDVCCR 91 € Glass door (unit) (Izq.-Left-Gauche) KPUIIVCCR Porte vitrée (unité)</p> <p style="text-align: center;">Cerradura puerta ciega (506X120; 506X121) 40 € Solid door lock Serrure porte inox</p> <p style="text-align: center;">Cerradura puerta cristal (506X60) 40 € Glass door lock Serrure porte vitrée</p> <p style="text-align: center;">115V/1ph/60Hz sin incremento / without supplement / sans supplément 230V/1ph/60Hz sin incremento / without supplement / sans supplément</p> | | | |

Serie / Series / Série VC

+Info: www.infrico.com

VC 2010 MDAB



Led de serie con tonalidad especial para carne.
Standard LEDs with a special meat tone.
LEDs standard avec une tonalité spéciale viande.



Puerta abatible para un acceso y limpieza más fácil.
Swing door for easy access and cleaning.
Porte battant pour un accès et un nettoyage faciles.

VC 1400 MDA



Puertas traseras de retorno automático, y bisagra con bloqueo.
Automatic return rear doors, and locking hinge.
Portes arrière à retour automatique, et charnière de blocage.

VC 2010 MDA

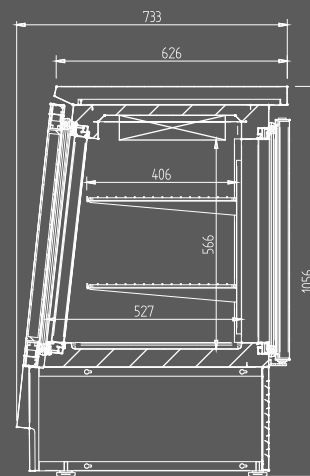

Armario madurador Dry Aging / Dry Aging meat cabinet / Armoire maturation Dry Aging



AC 140 MDAB



AC 280 MDAB

| MODELO MODELE MODÈLE | AC 140 MDAB | AC 280 MDAB |
|--|--|----------------------------|
| Precio Price Prix | 1.345 € | 2.475 € |
| Medidas Measures [mm] Mesures | 600 x 680 x 824 mm. | 600 x 656 x 1645 mm. |
| Temperatura Temperature Température | T° +0°C/+16°C | |
| | Humedad / humidity / humidité 45% HR / 85% HR | |
| Clase Climática Climatic class Classe climatique | 4 / 38°C | |
| Tensión/Frecuencia Electrical data Tension électrique | 230V/1ph/50Hz | |
| Controlador Controller Régulateur | Digital IP65 | |
| Material Material [EXT/INT] Matériel | Int: AISI 304 Ext: Acero Lacado Negro / Black Lacquered Steel / Acier Laqué Noir | |
| Espesor Thickness Épaisseur | 50 | |
| Aislamiento Isolation Isolation | 40kg/m ³ / Free CFC's / Zero ODP-GWP | |
| Capacidad Capacity Capacité | 141 | 340 |
| Puertas Doors Portes | 1 | 1 |
| Nº Estantes Shelves Nº Étagères | 1 | 3 |
| Sistema de frío Cooling System Système de froid | Forzado / Forced air / Ventilé | |
| Desescarche Defrost Dégivrage | Parada de compresor / Compresor off / Arrêt du compresseur | |
| Expansión Expansion Expansion | Capilar / Capillary / Capillaire | |
| Potencia Power Puissance | 115 | 720 |
| Potencia frig. Cooling capacity Puissance Frig. | 195 | 343 |
| Consumo Consumption Consommation | - | |
| Clase energética Energy class Classe Énerg. | - | |
| Refrigerante Refrigerant Gaz | R-290 | |
| Opcional Optional Options | <p>Manejo control digital bluetooth o wifi / Operating digital control bluetooth or wifi / Trait. de contrôle digital bluetooth ou wifi 143 €</p> <p>Estantes adicionales / Additional shelves / Étagères supplémentaires 68 €</p> <p>Ruedas / Casters / Roulettes (705X16=2; 705X17=2) 161 €</p> <p>115V/1ph/60Hz sin incremento / without supplement / sans supplément</p> <p>230V/1ph/60Hz sin incremento / without supplement / sans supplément</p> | |

Serie / Series / Série **AC**

+Info: www.infrico.com

AC 280 MDAB



AC 140 MDAB

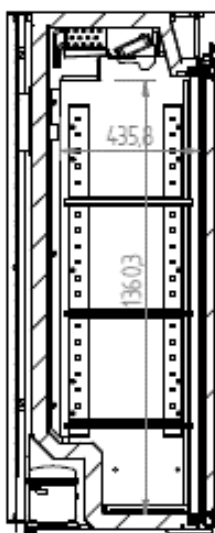

Led de serie con tonalidad especial para carne.
Standard LEDs with a special meat tone.
LEDs standard avec une tonalité spéciale viande.

Control electrónico de Temperatura y Humedad
Electronic Temperature and Humidity control
Contrôle électronique de la Température et de l'humidité

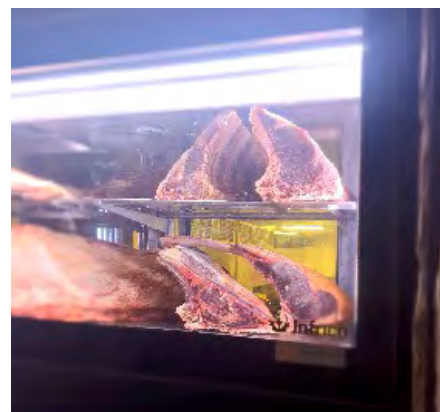
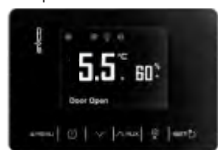

Armario de maduración de carne / Dry-aging meat cabinets / Armoire de maturation pour la viande

| MODELO/MODELE/MODÈLE | AMC6711L | AMC6714L | AMC8711L | AMC8714L | AMC6711XL | AMC6714XL | AMC8711XL | AMC8714XL |
|--|---|--------------------|--------------------|--------------------|--------------------|--------------------|--------------------|--------------------|
| Precio Price Prix | 7.514 € | 8.043 € | 8.448 € | 9.171 € | 8.874 € | 9.689 € | 10.181 € | 11.093 € |
| Medidas Measures (mm) Mesures | 650 650 1900 | 650 650 1900 | 850 650 1900 | 850 650 1900 | 650 650 2300 | 650 650 2300 | 850 650 2300 | 850 650 2300 |
| Tensión/Frecuencia Electrical data (V/Hz) Tension électrique | 220/50 | | | | | | | |
| Material Material Matériel | Triple cristal sin perfilera en aluminio, excepto puerta en doble cristal. Tratamiento para evitar entrada de rays U.V.A. Triple glazing without aluminum profiles, except door in double glazing. Treatment to avoid U.V.A rays. Triple vitrage sans perfilera en aluminium, sauf porte double vitrage. Traitement pour éviter l'entrée des rayons U.V.A. | | | | | | | |
| Capacidad Capacity Capacité | 450 | | 600 | | | 780 | | |
| Caras de cristal Glass sides Faces vitrées | 1 | 4 | 1 | 4 | 1 | 4 | 1 | 4 |
| Puertas Doors Portes | 1 | 1 | 1 | 1 | 1 | 1 | 1 | 1 |
| Temperatura Temperature (30°C) Température | +2°C / +6°C | | | | | | | |
| Potencia Power (W) Puissance | 992 | 992 | 997 | 997 | 1260 | 1260 | 1265 | 1265 |
| Refrigerante Refrigerant Gaz | HC R290 | | | | | | | |
| Opcional Optional Options | <p>[MODEL L] Kit ensamblaje [1 Kit cada 2 armarios] / Assembly kit [1 kit per 2 cupboards] / Kit de montage [1 kit pour 2 armoires] 547 € [MODEL XL] Kit ensamblaje [1 Kit cada 2 armarios] / Assembly kit [1 kit per 2 cupboards] / Kit de montage [1 kit pour 2 armoires] 602 €</p> <p>(mod. 650x1900 mm) Decor. Negra/Blanca/Brown Rusty / Decor. Black/White/Brown Rusty / Décor. noire/blanche/Marron Rusty 478 € (mod. 850x1900 mm) Decor. Negra/Blanca/Brown Rusty / Decor. Black/White/Brown Rusty / Décor. noire/blanche/Marron Rusty 661 € (mod. 650x2300 mm) Decor. Negra/Blanca/Brown Rusty / Decor. Black/White/Brown Rusty / Décor. noire/blanche/Marron Rusty 590 € (mod. 850x2300 mm) Decor. Negra/Blanca/Brown Rusty / Decor. Black/White/Brown Rusty / Décor. noire/blanche/Marron Rusty 763 €</p>  <p>Kit SIN MADURACIÓN / Kit WITHOUT DRY AGING / Kit SANS MATURATION -1.532 €</p> | | | | | | | |

A DESTACAR

La maduración en seco es una técnica de envejecimiento en seco de la carne con temperatura y humedad controladas. Con la maduración en seco, la carne en 5-8 semanas pierde del 10% al 20% de los líquidos.

La vitrina Dry Aged trabaja en un régimen de temperatura de +2°C a +6°C con humedad controlada del 45% al 80%.

Gama de armarios diseñados para la maduración de la Carne [+2 °C a +6 °C], con sistema de refrigeración ventilado.

Termostato SOFT TOUCH con pantalla gráfica de 2.8" y teclado táctil, control de humedad de serie.

Disponible en dos longitudes 650mm y 850mm, grupo frigorífico en la parte inferior AMC 67/87L o superior AMC67/87XL.

Doble barra carnicera y tres estantes de acero cromado o cristal [a elegir].

Modelos canalizables, hasta un máximo de 2 puertas. Estructura con ruedas.

Iluminación con doble tira de LED, tonalidad especial para carne.

BENEFITS

Dry ripening is a dry aging technique of meat with controlled temperature and humidity. With the maturation in dry, the meat in 5-8 weeks loses from 10% to 20% of the liquids.

The Dry Aged showcase works in a field of +2°C +6°C with controlled humidity of 45% to 80%.

Range of cabinets designed for the dry-aging meat [+ 2°C to + 6 °C], with ventilated cooling system.

SOFT TOUCH thermostat with 2.8 "graphic display and touch screen, humidity control standard.

Available in two lengths 650mm and 850mm, refrigeration unit in the lower part AMC 67/87L and in the upper part AMC67/87XL.

Double meat bar and and three chromed or glass shelves [free choice].

Modularity, there is the possibility of channeling different models independently of their size with the Assembly Kit, up to a maximum of 2 doors.

Structure with wheels.

Lighting with double LED strip, special tonality for meat.

À SOULIGNER

Gamme d'armoires conçue pour la maturation de la viande [+2°C jusqu'à +6°C], avec système de réfrigération ventilé.

Nouveau thermostat SOFT TOUCH avec écran graphique de 2,8" et clavier tactile interactif, contrôle d'humidité de série.

Finition standard SILVER QUARTZ, ou sur commande en NOIR OPAL et BLANC PERLE.

Disponible en deux longueurs 650mm et 850mm, groupe frigorifique en bas AMC 67/87L ou en haut AMC 67/87XL.

Modularité, il existe la possibilité de canaliser différents modèles indépendamment de leur dimension grâce à kit de montage, maximum 3 portes.

Structure avec roulettes.

Éclairage avec double LED spécial pour viande.

Serie / Series / Série **AMC**

+Info: www.infrico.com

AMC8714XL

**Modelo con unidad
frigorífica arriba
Negro Opcional**

Model with
refrigeration unit
on top
Black Optional

Modèle avec
unité de
refroidissement
au-dessus.
Noir en option



AMC6714XL

**Modelo Estándar
Silver Quartz**

Standard model
Silver Quartz

Modèle Standard
Silver Quartz











7





Armarios expositores de vino / Wines exhibiting cupboard / Armoire d'exposition pour le vin

| |  |  |  |  |  |  |  |  |
|---|---|---|---|---|--|---|---|---|
| MODELO/MODELE/MODÈLE | L06511V | L06512V | L06513V | L06514V | L08511V | L08512V | L08513V | L08514V |
| Precio Price Prix | 6.757 € | 7.129 € | 7.419 € | 7.654 € | 8.184 € | 8.529 € | 8.819 € | 9.153 € |
| Medidas Measures (mm) Mesures | 650 650 2300 | 650 650 2300 | 650 650 2300 | 650 650 2300 | 850 650 2300 | 850 650 2300 | 850 650 2300 | 850 650 2300 |
| Tensión/Frecuencia Electrical data (V/Hz) Tension électrique | 220/50 | | | | | | | |
| Material Material Matériel | Triple cristal excepto la puerta en doble cristal, cristal exterior e interior bajo emisivo. Triple crystal except the door in double glass, exterior glass and interior low emissive. Triple vitrage à l'exception de la porte qui est en double vitrage, vitrage extérieur et intérieur de faible émissivité. | | | | | | | |
| Capacidad Capacity Capacité | 600 [120 Botellas] | | | | 780 [160 Botellas] | | | |
| Caras de cristal Glass sides Faces vitrées | 1 | 2 | 3 | 4 | 1 | 2 | 3 | 4 |
| Puertas Doors Portes | 1 | 1 | 1 | 1 | 1 | 1 | 1 | 1 |
| Estantes Shelves Étagères | 3 | 3 | 3 | 3 | 3 | 3 | 3 | 3 |
| Temperatura Temperature (30°C) Température | +4°C / +18°C | | | | | | | |
| Condensación Condensation Condenseur | Ventilada / Ventilated / Ventilée | | | | | | | |
| Evaporación Evaporation Évaporateur | Ventilada / Ventilated / Ventilée | | | | | | | |
| Desescarche Defrost (Kg.) Dégivrage | Automático / Automatic / Automatique | | | | | | | |
| Potencia Power (W) Puissance | 1260 | 1260 | 1260 | 1260 | 1265 | 1265 | 1265 | 1265 |
| Refrigerante Refrigerant Gaz | HC R290 | | | | | | | |
| Opcional Optional Options | <p>Kit ensamblaje [1 Kit cada 2 armarios] / Assembly kit [1 kit per 2 cupboards] / Kit de montage [1 kit tous les 2 coffrets] 602 €</p> <p>Estructura plexiglás 90° [120 botellas] / 90° plexiglass structure [120 bottles] / Structure en plexiglas 90° [120 bouteilles] 1.473 €</p> <p>Estructura plexiglás 45° [66 botellas] / 45° plexiglass structure [66 bottles] / Structure en plexiglas 45° [66 bouteilles] 1.473 €</p> <p>Decoración Negra/Blanca/Brown Rusty / Decoration Black/White/Brown Rusty / Décoration noire/blanche/Marron Rusty (mod. 650 mm) 661 €</p> <p>Decoración Negra/Blanca/Brown Rusty / Decoration Black/White/Brown Rusty / Décoration noire/blanche/Marron Rusty (mod. 850 mm) 763 €</p> | | | | | | | |

A DESTACAR

Gama de armarios expositores de Vino [+4°C a +18°C].
Disponibile en dos longitudes 650mm y 850mm, con posibilidad de 1 a 4 caras de cristal.
Tres estantes de plexiglás regulables en altura, medidas 500x450mm (longitud 650mm), y medida 700x450mm (longitud 850mm).
Capacidad de hasta 120 botellas o 160 botellas según modelo.
Modelos canalizables hasta un máximo de 3 puertas.
Estructura con ruedas.
Iluminación con doble tira de LED con luz continua, mejora la visibilidad del producto expuesto.

BENEFITS

Range of wine display cabinets [+4°C to +18°C].
Available in two lengths 650mm and 850mm, with the possibility of 1 to 4 faces of glass.
Three plexiglass shelves adjustable in height, measured 500x450mm (length 650mm), and measurement 700x450mm (length 850mm).
Capacity up to 120 bottles or 160 bottles according to model.
Canalisable models up to a maximum of 3 doors.
Structure with wheels.
Double LED strip lighting with continuous light, improves the visibility of the exposed product.

À SOULIGNER

Gamme d'armoires d'exposition pour le vin [+4°C jusqu'à +18°C].
Disponibile en deux largeurs 650mm et 850mm, avec possibilité de 1 à 4 faces vitrées.
Distribution intérieure avec 3 étagères de plexiglas réglables en hauteur, dimensions 500x450mm (longueur 650mm), et dimensions 700x450mm (longueur 850mm).
Capacité jusqu'à 120 bouteilles ou 160 bouteilles selon modèle.
Modèles canalissables, maximum 3 portes.
Structure avec roulettes.
Éclairage avec double LED et lumière continue pour une meilleure visibilité du produit exposé.

Serie / Series / Série **VITRA V**

+Info: www.infrico.com



[longitud 850 mm,
altura 1900 mm]
Consultar precio

[wide 850 mm,
height 1900 mm]
Price to consult

[850mm longueur,
hauteur 1900mm]
Consulter prix

**Combinación de Armarios
Kit ensamblaje**
Combination of cabinets
Assembly kit
Combinaison d'armoires
Kit d'assemblage

L08513V + L08513V



Opción / Option / Option
**Estructura plexiglás 90° y 45°
sólo para modelos de longitud 850mm**

Plexiglass structure 90° y 45°
only for wide 850mm models

Option structure 90° et 45° plexiglas
seulement disponible armoires de 850mm



[650 mm longitud,
altura 2300 mm]
[wide 650 mm,
height 2300 mm]
[650mm longueur,
hauteur 2300mm]

[650 mm longitud,
altura 2300 mm]
[wide 650 mm,
height 2300 mm]
[650mm longueur,
hauteur 2300mm]

L06511V



L06514V











**Termostato
Soft touch
Thermostat tactile**

Expositor de vino en madera / Wine cellars / Armoire à vin

Expositor de vino en acero lacado/ Retro-wine cellars / Armoire à vin et gourmet

Exterior de madera maciza [Cerezo] / Solid wood exterior [Cherry] / Extérieur en bois massif [Cerisier]

| MODELO MODELE MODÈLE |  |  |  |  |  |
|---|--|---|---|--|---|
| | EVV70 | EVV100 | EVV200MX | EVV 23 R1G | EVV 49 R2G |
| Precio Price Prix | 2.147 € | 3.436 € | 5.467 € | 4.272 € | 6.251 € |
| Medidas Measures [mm] Mesures | 600 x 656 x 1645 mm. | 657 x 596 x 1918 mm. | 1314 x 596 x 1918 mm. | 690 x 602 x 2032 mm. | 1385 x 602 x 2032 mm. |
| Temperatura Temperature Température | +4°C/+18°C | | | | |
| Clase Climática Climatic class Classe climatique | 4 / 38°C | | | | |
| Tensión/Frecuencia Electrical data Tension électrique | 230V/1ph/50Hz | | | | |
| Controlador Controller Régulateur | Digital / Digital / Électronique IP65 | | | | |
| Material Material [EXT/INT] Matériel | Ext: Acero Lacado Negro / Black Lacquered Steel / Acier Laqué Noir Int: AISI 304 | 100% Madera de pino maciza / 100% Pine wood / 100% en bois de pin massif Acero plastif. gris / Grey plastic coated steel / Acier plastifié gris | | 100% Madera de pino maciza / 100% Pine wood / 100% en bois de pin massif Interior AISI 430 / Inetrior AISI 430 / Intérieure AISI 430 | |
| Espesor Thickness Épaisseur | 50 | 50 | | 95 | |
| Aislamiento Isolation Isolation | 40kg/m ³ / Free CFC's / Zero ODP-GWP | | | | |
| Capacidad Capacity Capacité | 340 (L) | 350 | 350+350 | 265 | 640 |
| Puertas Doors Portes | 1 | 1 | 2 | 1 | 2 |
| N° parrillas / Guías N° shelves / Slides N° de grilles / Glissière | 5 | 7 | 14 | 5 | 10 |
| Capacidad botellas Bottle rack Nombre de bouteilles | 70 | 100 | 100 + 100 | 90 | 90 + 90 |
| Sistema de frío Cooling System Système de froid | Forzado / Forced air / Ventilé | | | | |
| Desescarche Defrost Dégivrage | Parada de compresor / Compressor off / Arrêt du compresseur | | | | |
| Expansión Expansion Expansion | Capilar / Capillary / Capillaire | | | | |
| Potencia Power Puissance | 720 (W) | 335 | 785 | 255 | 440 |
| Potencia frig. Cooling capacity Puissance Frig. [W A -10°C] | 343 | 370 | | 370 | 690 |
| Consumo Consumption Consommation [kWh/ 24h] | - | | | | |
| Refrigerante Refrigerant Gaz | R-290 | | | | |
| Opcional Optional Options | |  Cerezo / Cherry / Cerisier Estándar / Standard / Standard |  Negro / Black / Noir RAL 9017 (EVV23R1G) 243 € (EVV49R2G) 426 € |  Blanco / White / Blanc RAL 9016 (EVV23R1G) 243 € (EVV49R2G) 426 € | |
| | | 115V/1ph/60Hz 230V/1ph/60Hz | sin incremento / without supplement / sans supplément sin incremento / without supplement / sans supplément | | |
| | | | Parrilla de madera / Wooden shelves / Gril en bois [PMADAR1P] 96 € | | |

Serie / Series / Série **EVV / VINTAGE**

+Info: www.infrico.com

EVV200MX



Doble temperatura
Dual temperature
Double température

Video del producto
Product Video
Vidéo du produit



Infrico Youtube

Negro opcional
Optional black
Noir en option

EVV70



**La temperatura recomendada para el Vino Tinto está entre 10°C y 18°C .
Blanco, Rosado y Brut entre 4°C y 8°C.**

**Recommended temperature for red wine is 10°C to 18°C.
White, rosé and brut is 4°C to 8°C.**

**La température recommandée, vin rouge entre 10°C à 18°C.
Blanc, Rosé et Brut entre 4°C à 8°C.**



EVV100



Parrillas de madera ▶
Wood grills
Grilles en bois



◀ **Parrillas de acero lacado y madera**
Painted steels and wood grills
Grilles en acier et en bois



Blanco opcional
Option white
Blanc en option



EVV 49 R2G



Expositor Modular de Cristal climatizado con control de Humedad /
Modular Glass Display Cabinet with Humidity control /
Expositeur modulaire en vitre avec contrôle de l'humidité



7

ALUMINIUM STRUCTURE FINISHINGS



Aluminio



Bronce



Negro opaco

WOODEN PANELS FINISHINGS

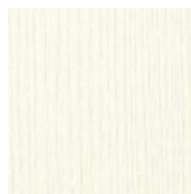

Artico

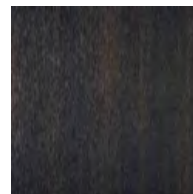

Moka



Caramelo



A DESTACAR















Expositores Modular de cristal para Vino Tinto (+15°C a +18°C) y humedad (50/70%)
 Paneles disponibles en dos dimensiones: 50x230cm y 100x230cm.
 Paneles de Vidrio de 2 hojas laminado de 5+5
 Fácil instalación sobre suelo
 Estructura de aluminio, guías de suelo y techo, escuadras e intersección.
 Tres acabados de panel de madera y perfiles de aluminio.

BENEFITS

Modular glass displays for red wine (+15°C to +18°C) and humidity (50/70%).
 Panels available in two sizes: 50x230cm and 100x230cm.
 5+5" double laminated glass panels.
 Easy installation on the floor
 Aluminium structure, floor and ceiling guides, brackets and intersection.
 Three finishes of wood panels and aluminium profiles.

À SOULIGNER

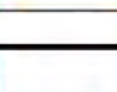
Présentoirs modulaires en verre pour le vin rouge (+15°C à +18°C) et l'humidité (50/70%).
 Panneaux disponibles en deux tailles : 50x230cm et 100x230cm.
 Panneaux en double verre feuilleté de 5+5".
 Installation facile au sol
 Structure en aluminium, guides au sol et au plafond, supports et intersection.
 Trois finitions de panneaux en bois et de profils en aluminium.

|  |  |  cm |  |  u.f. |  m ³ |  kW |
|---|---|--|---|---|---|---|
| WN1515 |  | ↔ 165 ↗ 165 ↓ 240 | +15/+18°C | 50/70% | 5,3 | 1 |
| WN2010 |  | ↔ 215 ↗ 115 ↓ 240 | +15/+18°C | 50/70% | 4,6 | 1 |
| WN2015 |  | ↔ 215 ↗ 165 ↓ 240 | +15/+18°C | 50/70% | 6,9 | 1 |
| WN2020 |  | ↔ 215 ↗ 215 ↓ 240 | +15/+18°C | 50/70% | 9,2 | 1 |
| WN2525 |  | ↔ 265 ↗ 265 ↓ 240 | +15/+18°C | 50/70% | 14,4 | 2 |
| WN3015 |  | ↔ 315 ↗ 165 ↓ 240 | +15/+18°C | 50/70% | 10,3 | 2 |
| WN3020 |  | ↔ 315 ↗ 215 ↓ 240 | +15/+18°C | 50/70% | 13,8 | 2 |







Vitrinas Expositoras

Display cases / Vitrines d'exposition





Serie / Series / Série

VEB/VEP

VEP P

VEB CC

VEB CP

238-241

Serie / Series / Série

VET

VET P

VET DP

VET GR

VET DP GR

242-243

Serie / Series / Série

VSU

VSU P

VSU PR

244-245

Serie / Series / Série

VIP

VIP 1/4 C

VIP 1/4 T

VIP 1/3 C

VIP 1/3 T

246-249

Serie / Series / Série

VMS

VMS I

250-251

Serie / Series / Série

VC

VC

250-251

Serie / Series / Série

VRP / VML
Málaga

VRP

VML

252-253

Serie / Series / Série

JULIET

VJU

254-255

Serie / Series / Série

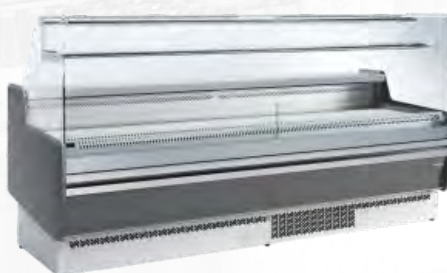
VMB
Marbella

VMB RU/RIU

VMB RUP/RIUP

VMB C/M

256-257-260

Serie / Series / Série

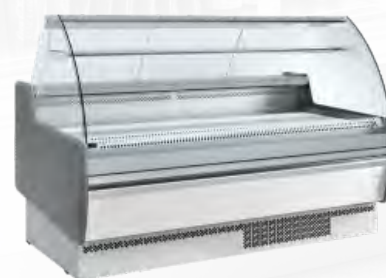
VMC
Mallorca

VMC RU/RIU

VMC C/M

258-259-260

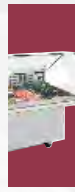

8. Vitrinas Expositoras

Display cases / Vitrines d'exposition

Estructura de cristales de alta transparencia, rectos o curvos según modelo.

High transparency glass structure, flat or curved depending on the model.

Structure en verre à haute transparence, droite ou bombée selon le modèle.

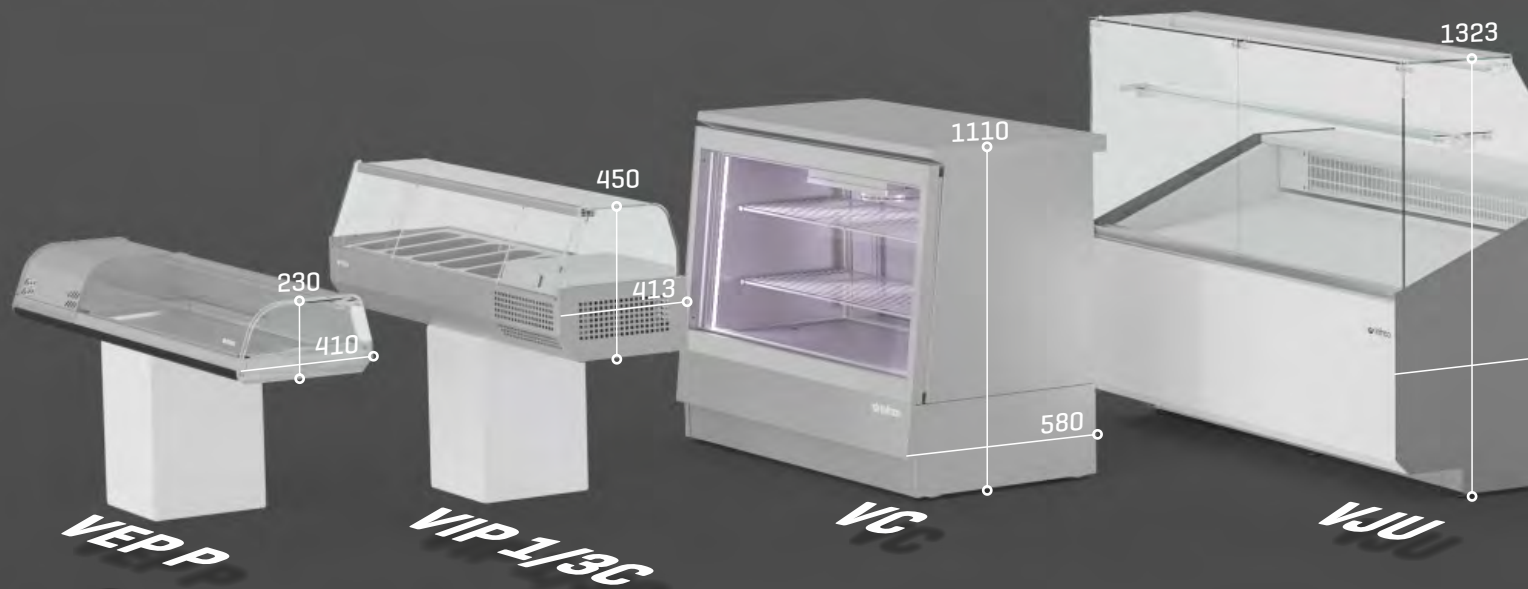

Iluminación / Lighting / Éclairage

Incorporación de iluminación LED, llegando a reducir el consumo energético entre un 80% y 90%, respecto a una bombilla tradicional.

LED lighting incorporated, reducing energetic consumption between 80% and 90% respect to a traditional light bulb.

Éclairage LED, réduisant la consommation énergétique entre 80% et 90%, par rapport à une ampoule traditionnelle.



+Info: www.infrico.com

Equipos con posibilidad de grupo remoto y grupo incorporado.

Devices with the possibility of remote group and integrated group.

Équipement avec la possibilité de groupe à distance et de groupe incorporé.

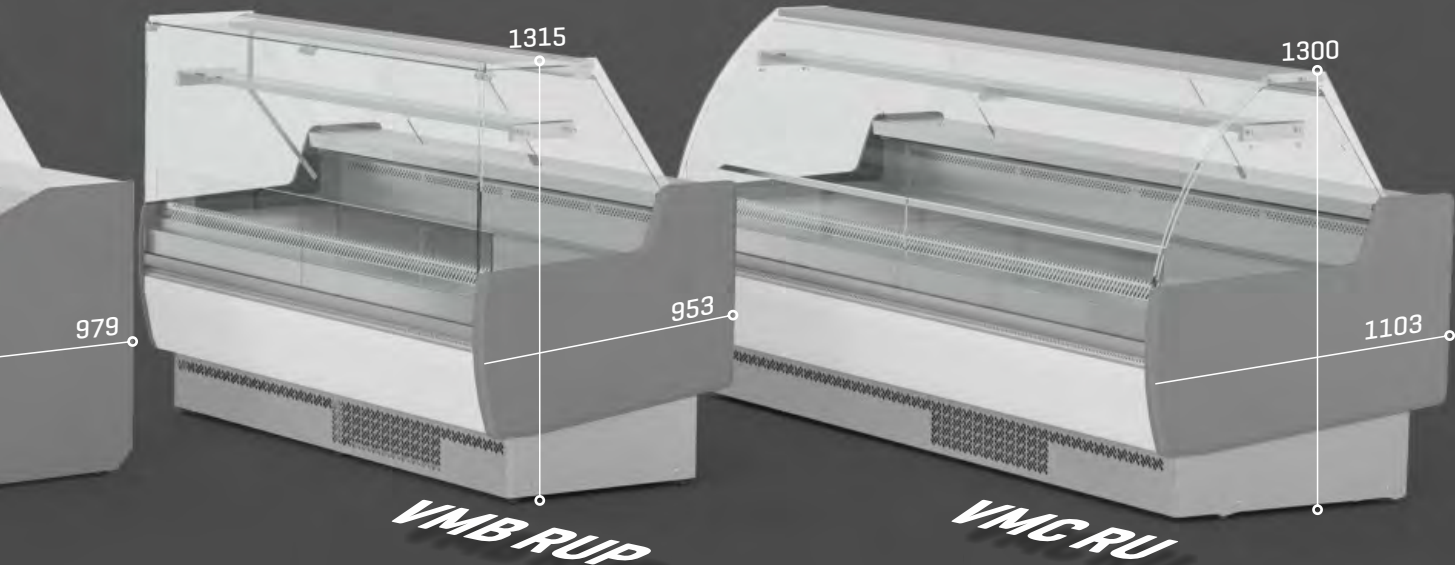
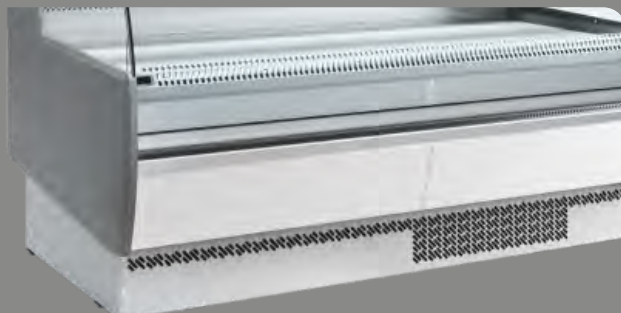

Máxima visibilidad de producto expuesto.

Maximum visibility of displayed product.

Visibilité maximale du produit exposé.



Expositor de barra y platos / Bar display exhibitor case and plate / Vitrine à tapas

| MODELO MODELE MODÈLE | VEP | | | | VEB | | | |
|---|--|----------------------------|----------------------------|---------------------------|----------------------------|----------------------------|----------------------------|----------------------------|
| | VEP 4 P | VEP 6 P | VEP 8 P | VEB 4 CC | VEB 6 CC | VEB 7 CC | VEB 8 CC | VEB 9 CC |
| Precio Price Prix | 1.316 € | 1.409 € | 1.502 € | 1.044 € | 1.170 € | 1.220 € | 1.266 € | 1.334 € |
| Medidas Measures Mesures (mm) | 1268 x 410 x 230 mm. | 1620 x 410 x 230 mm. | 1972 x 410 x 230 mm. | 810 x 415 x 195 mm. | 1162 x 415 x 195 mm. | 1338 x 415 x 195 mm. | 1514 x 415 x 195 mm. | 1690 x 415 x 195 mm. |
| Temperatura Temperature Température (°C) | -1°C/+7°C | | | | | | | |
| Clase Climática Climatic class Classe climatique (°C) | 4 / 38°C | | | | | | | |
| Tensión/Frecuencia Electrical data Tension électrique | 230V/1ph/50Hz | | | | | | | |
| Controlador Controller Régulateur | Digital | | | | | | | |
| Material Material Matériel (EXT/INT) | Aluminio anodizado / Anodized aluminium / Aluminium anodisé Inox AISI 304 | | | | | | | |
| Espesor Thickness Épaisseur (mm) | 70 | | | | | | | |
| Aislamiento Isolation Isolation (mm) | 40kg/m ³ / Free CFC's / Zero ODP-GWP | | | | | | | |
| Capacidad Capacity Capacité (L) | 9,2 | 13,6 | 18,4 | 9,2 | 13,6 | 16,0 | 18,4 | 20,4 |
| Superficie exposición Surface exhibition Surface d'exposition (m ²) | 0,23 | 0,34 | 0,46 | 0,23 | 0,34 | 0,40 | 0,46 | 0,51 |
| Nº puertas Doors Nº de portes | 2 | | | 1 | | | | |
| Sistema de frío Cooling System Système de froid | Ventilado / Ventilated / Ventilé | | | | | | | |
| Desescarche Defrost Dégivrage | Manual / Manual / Manuel | | | | | | | |
| Expansión Expansion Expansion | Capilar / Capillary / Capillaire | | | | | | | |
| Potencia Power Puissance (W) | 129 | 131 | 133 | 129 | 131 | 132 | 132 | 133 |
| Potencia frig. Cooling capacity Puissance Frig. (W A -10°C) | 169 | | | | | | | |
| Consumo Consumption Consommation (kWh/ 24h) | 1,93 | 1,96 | 1,99 | 1,93 | 1,95 | 1,97 | 1,98 | 2,00 |
| Área refrigerada Refrigerated area Zone réfrigérée (m ²) | 0,39 | 0,5 | 0,61 | 0,24 | 0,35 | 0,4 | 0,45 | 0,51 |
| Refrigerante Refrigerant Gaz | R-600 | | | | | | | |
| Opcional Optional Options | - | | | | | | | |

Serie / Series / Série **VEP & VEB**

+Info: www.infrico.com

VEB 8 CC



Expositor encastrable
Drop-in exhibitor
Présentoir encastrable

VEP 6 P

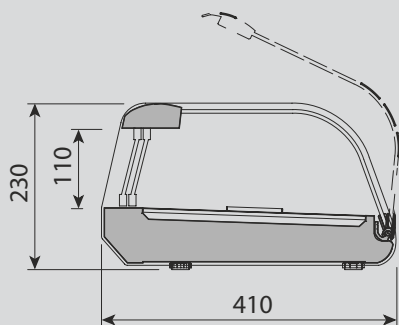



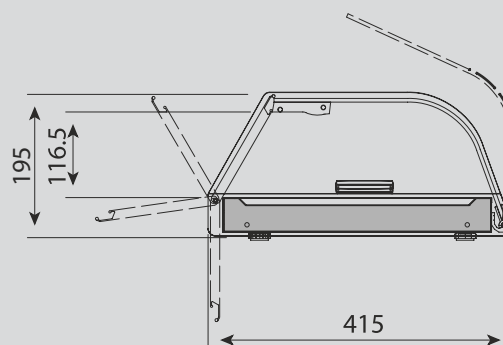

VEP P



VEB CC



Expositor de barra y platos / Bar display exhibitor case and plate / Vitrine à tapas







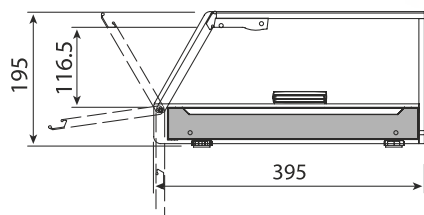



| MODELO MODELE MODÈLE |  |  |  |  |  |
|--|---|---|--|---|---|
| | VEB 4 CP | VEB 6 CP | VEB 7 CP | VEB 8 CP | VEB 9 CP |
| Precio Price Prix | 1.015 € | 1.140 € | 1.184 € | 1.228 € | 1.296 € |
| Medidas Measures Mesures (mm) | 810 x 395 x 195 mm. | 1162 x 395 x 195 mm. | 1338 x 395 x 195 mm. | 1514 x 395 x 195 mm. | 1690 x 395 x 195 mm. |
| Temperatura Temperature Température (°C) | -1°C/+7°C | | | | |
| Clase Climática Climatic class Classe climatique (°C) | 4 / 38°C | | | | |
| Tensión/Frecuencia Electrical data Tension électrique | 230V/1ph/50Hz | | | | |
| Controlador Controller Régulateur | Digital | | | | |
| Material Material Matériel (EXT/INT) | Aluminio anodizado / Anodized aluminium / Aluminium anodisé Inox AISI 304 | | | | |
| Espesor Thickness Épaisseur (mm) | 70 | | | | |
| Aislamiento Isolation Isolation (mm) | 40kg/m ³ / Free CFC's / Zero ODP-GWP | | | | |
| Capacidad Capacity Capacité (L) | 9,2 | 13,6 | 16,0 | 18,4 | 20,4 |
| Superficie exposición Surface exhibition Surface d'exposition (m ²) | 0,23 | 0,34 | 0,40 | 0,46 | 0,51 |
| Nº puertas Doors Nº de portes | | | | | |
| Sistema de frío Cooling System Système de froid | Ventilado / Ventilated / Ventilé | | | | |
| Desescarche Defrost Dégivrage | Manual / Manual / Manuel | | | | |
| Expansión Expansion Expansion | Capilar / Capillary / Capillaire | | | | |
| Potencia Power Puissance (W) | 129 | 131 | 132 | 132 | 133 |
| Potencia frig. Cooling capacity Puissance Frig. (W A -10°C) | 169 | | | | |
| Consumo Consumption Consumation (kWh/ 24h) | 1,93 | 1,95 | 1,97 | 1,98 | 2,00 |
| Área refrigerada Refrigerated area Zone réfrigérée (m ²) | 0,24 | 0,35 | 0,4 | 0,45 | 0,51 |
| Refrigerante Refrigerant Gaz | R-600 | | | | |
| Opcional Optional Options | - | | | | |

Serie / Series / Série **VEP & VEB**

+Info: www.infrico.com



Expositor de tapas y pintxos / Bar display exhibitor case and plate / Vitrine à tapas

| MODELO MODELE MODÈLE |  |  |  |  |  |  |  |  |  |  |
|--|---|---|---|---|---|--|---|---|---|---|
| | VET 4 P | VET 6 P | VET 8 P | VET 4 DP | VET 6 DP | VET 8 DP | VET 7 P GR | VET 9 P GR | VET 7 DP GR | VET 9 DP GR |
| Precio Price Prix | 1.228 € | 1.374 € | 1.514 € | 1.423 € | 1.602 € | 1.790 € | 1.343 € | 1.520 € | 1.543 € | 1.715 € |
| Medidas Measures Mesures (mm) | 1268 x 410 x 230 mm. | 1620 x 410 x 230 mm. | 1972 x 410 x 230 mm. | 1268 x 412 x 330 mm. | 1620 x 412 x 330 mm. | 1972 x 412 x 330 mm. | 1338 x 410 x 230 mm. | 1690 x 410 x 230 mm. | 1338 x 412 x 330 mm. | 1690 x 412 x 330 mm. |
| Temperatura Temperature Température (°C) | -1°C/+7°C | | | | | | | | | |
| Clase Climática Climatic class Classe climatique (°C) | 4 / 38°C | | | | | | | | | |
| Tensión/Frecuencia Electrical data Tension électrique | 230V/1ph/50Hz | | | | | | | | | |
| Controlador Controller Régulateur | Digital | | | | | | | | | |
| Material Material Matériel (EXT/INT) | Aluminio anodizado / Anodized aluminium / Aluminium anodisé Inox AISI 304 | | | | | | | | | |
| Espesor Thickness Épaisseur (mm) | 70 | | | | | | | | | |
| Aislamiento Isolation Isolation (mm) | 40kg/m ³ / Free CFC's / Zero ODP-GWP | | | | | | | | | |
| Capacidad Capacity Capacité (L) | 9,2 | 13,6 | 18,4 | 9,2 | 13,6 | 18,4 | 16,0 | 20,4 | 16,0 | 20,4 |
| Superficie exposición Surface exhibition Surface d'exposition (m ²) | 0,23 | 0,34 | 0,46 | 0,23 | 0,34 | 0,46 | 0,40 | 0,51 | 0,40 | 0,51 |
| Bandejas GN Trays GN Grilles GN | 4 | 6 | 8 | 4 | 6 | 8 | 7 | 9 | 7 | 9 |
| Sistema de frío Cooling System Système de froid | Ventilado / Ventilated / Ventilé | | | | | | | | | |
| Desescarche Defrost Dégivrage | Manual / Manual / Manuel | | | | | | | | | |
| Expansión Expansion Expansion | Capilar / Capillary / Capillaire | | | | | | | | | |
| Potencia Power Puissance (W) | 129 | 131 | 133 | 133 | 136 | 140 | 131 | 133 | 131 | 133 |
| Potencia frig. Cooling capacity Puissance Frig. (W A -10°C) | 169 | | | | | | | | | |
| Consumo Consumption Consommation (kWh/24h) | 1,79 | 1,82 | 1,84 | 1,85 | 1,90 | 1,96 | 1,83 | 1,83 | 1,86 | 1,86 |
| Área refrigerada Refrigerated area Zone réfrigérée (m ²) | 0,41 | 0,52 | 0,63 | 0,72 | 0,92 | 1,12 | 0,43 | 0,54 | 0,76 | 0,96 |
| Refrigerante Refrigerant Gaz | R-600a | | | | | | | | | |
| Opcional Optional Options | - | | | | | | | | | |

Serie / Series / Série **VET**

+Info: www.infrico.com

VET 8 P



VET 6 DP



Expositor encastrable
Drop-in exhibitor
Présentoir encastrable

VET 7 DP GR

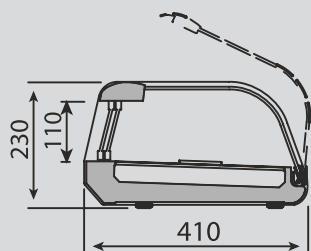

VET P

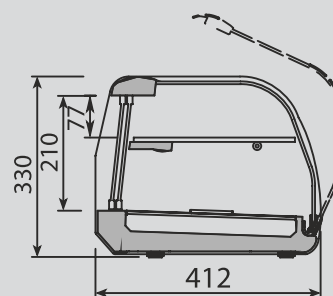

VET DP / DP GR

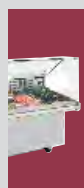

Expositor sushi, pescado y marisco / Sushi, fish and seafood display case / Vitrine sushi, poisson et crustacés

| MODELO MODELE MODÈLE |  |  |  |  |  |  |
|--|---|---|---|--|---|---|
| | VSU 4 P | VSU 6 P | VSU 8 P | VSU 4 PR | VSU 6 PR | VSU 8 PR |
| Precio Price Prix | 1.629 € | 1.808 € | 1.984 € | 1.629 € | 1.808 € | 1.984 € |
| Medidas Measures Mesures (mm) | 1268 x 410 x 230 mm. | 1620 x 410 x 230 mm. | 1972 x 410 x 230 mm. | 1268 x 410 x 230 mm. | 1620 x 410 x 230 mm. | 1972 x 410 x 230 mm. |
| Temperatura Temperature Température (°C) | -1°C/+7°C | | | | | |
| Clase Climática Climatic class Classe climatique (°C) | 3 / 25°C | | | | | |
| Tensión/Frecuencia Electrical data Tension électrique | 230V/1ph/50Hz | | | | | |
| Controlador Controller Régulateur | Digital | | | | | |
| Material Material Matériel (EXT/INT) | Aluminio anodizado / Anodized aluminium / Aluminium anodisé Inox AISI 304 | | | | | |
| Espesor Thickness Épaisseur (mm) | 70 | | | | | |
| Aislamiento Isolation Isolation (mm) | 40kg/m ³ / Free CFC's / Zero ODP-GWP | | | | | |
| Capacidad Capacity Capacité (L) | 9,2 | 13,3 | 15,5 | 9,2 | 13,3 | 15,5 |
| Superficie exposición Surface exhibition Surface d'exposition (m ²) | 0,23 | 0,34 | 0,46 | 0,23 | 0,34 | 0,46 |
| Nº puertas Doors Nº de portes | 2 | | | | | |
| Sistema de frío Cooling System Système de froid | Ventilado / Ventilated / Ventilé | | | | | |
| Desescarche Defrost Dégivrage | Manual / Manual / Manuel | | | | | |
| Expansión Expansion Expansion | Capilar / Capillary / Capillaire | | | | | |
| Potencia Power Puissance (W) | 225 | 227 | 228 | 225 | 227 | 228 |
| Potencia frig. Cooling capacity Puissance Frig. (W A -10°C) | 370 | | | | | |
| Consumo Consumption Consommation (kWh/ 24h) | 4,81 | 4,83 | 4,85 | 4,81 | 4,83 | 4,85 |
| Área refrigerada Refrigerated area Zone réfrigérée (m ²) | 0,23 | 0,34 | 0,46 | 0,23 | 0,34 | 0,46 |
| Refrigerante Refrigerant Gaz | R-290a | | | | | |
| Opcional Optional Options | - | | | | | |

Serie / Series / Série **VSU**

+Info: www.infrico.com

VSU 8 P

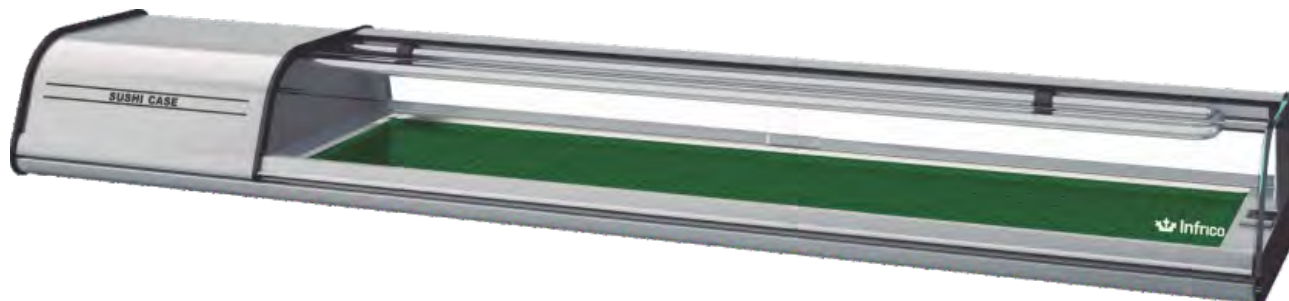

VSU 8 PR

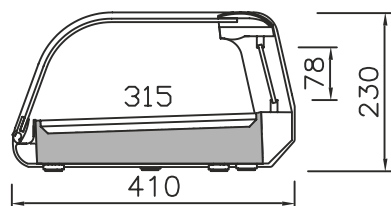









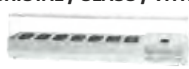

VSU P / PR

Desagüe en la parte inferior
Bottom drain
Drainage au fond



Vitrina para pizza y sandwiches, cuba 1/4 / Refrigerated pizzas & sandwiches cases, 1/4 trays / Vitrine ingrédients pizzas & sandwiches 1/4

| MODELO MODELE MODÈLE |  |  |  |  |  |
|--|--|---|--|---|---|
| | VIP 1330 1/4 C | VIP 1490 1/4 C | VIP 1740 1/4 C | VIP 1980 1/4 C | VIP 2300 1/4 C |
| Precio Price Prix | 1.647 € | 1.696 € | 1.743 € | 1.830 € | 1.923 € |
| Medidas Measures Mesures (mm) | 1328 x 353 x 450 mm. | 1493 x 353 x 450 mm. | 1733 x 353 x 450 mm. | 1976 x 353 x 450 mm. | 2300 x 353 x 450 mm. |
| MODELO MODELE MODÈLE |  |  |  |  |  |
| | VIP 1330 1/4 T | VIP 1490 1/4 T | VIP 1740 1/4 T | VIP 1980 1/4 T | VIP 2300 1/4 T |
| Precio Price Prix | 1.394 € | 1.442 € | 1.491 € | 1.598 € | 1.720 € |
| Medidas Measures Mesures (mm) | 1328 x 353 x 260 mm. | 1493 x 353 x 260 mm. | 1733 x 353 x 260 mm. | 1976 x 353 x 260 mm. | 2300 x 353 x 260 mm. |
| Temperatura Temperature Température (°C) | -1°C/+7°C | | | | |
| Clase Climática Climatic class Classe climatique (°C) | 4 / 38°C | | | | |
| Tensión/Frecuencia Electrical data Tension électrique | 230V/1ph/50Hz | | | | |
| Controlador Controller Régulateur | Digital | | | | |
| Material Material (EXT/INT) Matériel | Inox AISI 304 | | | | |
| Espesor Thickness Épaisseur (mm) | 70 | | | | |
| Aislamiento Isolation Isolation (mm) | 40kg/m ³ / Free CFC's / Zero ODP-GWP | | | | |
| Capacidad Capacity Capacité (L) | 32 | 37 | 48 | 57 | 70 |
| Superficie exposición Surface exhibition Surface d'exposition (m ²) | 0,20 | 0,24 | 0,31 | 0,37 | 0,45 |
| Compresor Compressor Compresseur (HP) | - | | | | |
| Sistema de frío Cooling System Système de froid | Ventilado / Ventilated / Ventilé | | | | |
| Desescarche Defrost Dégivrage | Manual / Manual / Manuel | | | | |
| Expansión Expansion Expansion | Capilar / Capillary / Capillaire | | | | |
| Potencia Power Puissance (W) | 125 | | | | |
| Potencia frig. Cooling capacity Puissance Frig. (W A -10°C) | 169 | | | | |
| Consumo Consumption Consommation (kWh/ 24h) | 1,33 | 1,36 | 1,39 | 1,41 | 1,44 |
| Refrigerante Refrigerant Gaz | R-600a | | | | |
| Opcional Optional Options | Puertas correderas traseras MOD. C / Rear sliding doors MOD. C / Portes coulissantes arrière MOD. C | | | | |
| | KPUVIP134C 198 € | KPUVIP144C 223€ | KPUVIP174C 252 € | KPUVIP194C 294 € | KPUVIP234C 342 € |

Serie / Series / Série **VIP**

+Info: www.infrico.com

VIP 2300 1/4 T
TAPA / LID / COUVERCLE INOX



VIP 2300 1/4 C
CRISTAL / GLASS / VITRÉE



Puertas correderas traseras
Rear sliding doors
Portes coulissantes arrière

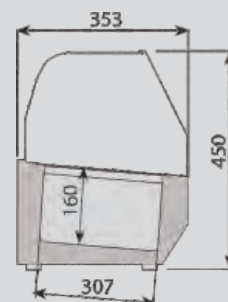

VIP 1/4 C
CRISTAL / GLASS / VITRÉE

VIP 1330 1/4
{501X13} = 1 {501X16} = 3



VIP 1490 1/4
{501X16} = 6



VIP 1740 1/4
{501X13} = 1 {501X16} = 5



VIP 1980 1/4
{501X13} = 1





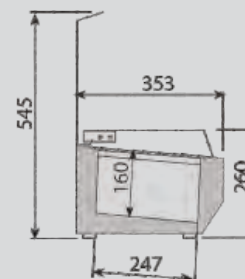







VIP 2300 1/4
{501X13} = 1 {501X16} = 9



VIP 1/4 T
TAPA / LID / COUVERCLE INOX

Vitrina para pizza y sandwiches, cuba 1/3 / Refrigerated pizza & sandwiches cases, 1/3 trays / Vitrine ingrédients pizza & sandwiches 1/3

| MODELO MODELE MODÈLE |  |  |  |  |  |
|--|--|---|--|---|---|
| | VIP 1330 1/3 C | VIP 1490 1/3 C | VIP 1740 1/3 C | VIP 1980 1/3 C | VIP 2300 1/3 C |
| Precio Price Prix | 1.684 € | 1.743 € | 1.805 € | 1.865 € | 1.974 € |
| Medidas Measures Mesures (mm) | 1328 x 413 x 450 mm. | 1493 x 413 x 450 mm. | 1733 x 413 x 450 mm. | 1976 x 413 x 450 mm. | 2300 x 413 x 450 mm. |
| MODELO MODELE MODÈLE |  |  |  |  |  |
| | VIP 1330 1/3 T | VIP 1490 1/3 T | VIP 1740 1/3 T | VIP 1980 1/3 T | VIP 2300 1/3 T |
| Precio Price Prix | 1.443 € | 1.491 € | 1.539 € | 1.637 € | 1.707 € |
| Medidas Measures Mesures (mm) | 1328 x 413 x 260 mm. | 1493 x 413 x 260 mm. | 1733 x 413 x 260 mm. | 1976 x 413 x 260 mm. | 2300 x 413 x 260 mm. |
| Temperatura Temperature Température (°C) | -1°C/+7°C | | | | |
| Clase Climática Climatic class Classe climatique (°C) | 4 / 38°C | | | | |
| Tensión/Frecuencia Electrical data Tension électrique | 230V/1ph/50Hz | | | | |
| Controlador Controller Régulateur | Digital | | | | |
| Material Material (EXT/INT) Matériel | Inox AISI 304 | | | | |
| Espesor Thickness Épaisseur (mm) | 70 | | | | |
| Aislamiento Isolation Isolation (mm) | 40kg/m ³ / Free CFC's / Zero ODP-GWP | | | | |
| Capacidad Capacity Capacité (L) | CRISTAL / GLASS / VITRÉE TAPA / LID / COUVERCLE | CRISTAL / GLASS / VITRÉE TAPA / LID / COUVERCLE | CRISTAL / GLASS / VITRÉE TAPA / LID / COUVERCLE | CRISTAL / GLASS / VITRÉE TAPA / LID / COUVERCLE | CRISTAL / GLASS / VITRÉE TAPA / LID / COUVERCLE |
| Superficie exposición Surface exhibition Surface d'exposition (m ²) | CRISTAL / GLASS / VITRÉE TAPA / LID / COUVERCLE | CRISTAL / GLASS / VITRÉE TAPA / LID / COUVERCLE | CRISTAL / GLASS / VITRÉE TAPA / LID / COUVERCLE | CRISTAL / GLASS / VITRÉE TAPA / LID / COUVERCLE | CRISTAL / GLASS / VITRÉE TAPA / LID / COUVERCLE |
| Compresor Compressor Compresseur (HP) | - | | | | |
| Sistema de frío Cooling System Système de froid | Ventilado / Ventilated / Ventilé | | | | |
| Desescarche Defrost Dégivrage | Manual / Manual / Manuel | | | | |
| Expansión Expansion Expansion | Capilar / Capillary / Capillaire | | | | |
| Potencia Power Puissance (W) | 125 | | | | |
| Potencia frig. Cooling capacity Puissance Frig. (W A -10°C) | 169 | | | | |
| Consumo Consumption Consommation (kWh/ 24h) | 1,35 | 1,37 | 1,40 | 1,43 | 1,45 |
| Refrigerante Refrigerant Gaz | R-600a | | | | |
| Opcional Optional Options | Puertas correderas traseras MOD. C / Rear sliding doors MOD. C / Portes coulissantes arrière MOD. C | | | | |
| | KPUVIP133C 198 € | KPUVIP143C 223€ | KPUVIP173C 252 € | KPUVIP193C 294 € | KPUVIP233C 342 € |

Serie / Series / Série **VIP**

+Info: www.infrico.com

VIP 2300 1/3 T
TAPA / LID / COUVERCLE INOX



VIP 2300 1/3 C
CRISTAL / GLASS / VITRÉE



Opcion/Option/Option
Puertas correderas traseras
Rear sliding doors
Portes coulissantes arrière

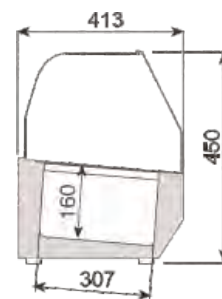

VIP 1/3 C
CRISTAL / GLASS / VITRÉE

VIP 1330 1/3
(501X13) = 1 (501X11) = 3



VIP 1490 1/3
(501X13) = 1 (501X11) = 4



VIP 1740 1/3
(501X13) = 1 (501X11) = 5



VIP 1980 1/3
(501X11) = 8



VIP 2300 1/3
(501X11) = 10

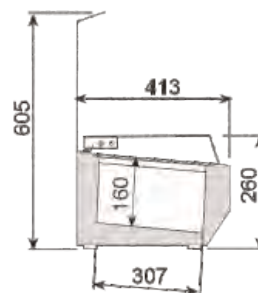

VIP 1/3 T
TAPA / LID / COUVERCLE INOX

Vitrina mural sobre mostrador / Wall display counter case / Vitrine murale

Vitrina cerrada refrigerada / 3/4 vision counter case / Vitrine réfrigérée comptoir panoramique

| MODELO MODELE MODÈLE | VMS 1000 I | VMS 1350 I | VMS 1500 I | VC 1400 | VC 2010 | | | |
|--|---|-----------------------------|-----------------------------|---|---|---|---|--|
| Precio Price Prix | 2.248 € | 2.396 € | 2.512 € | 3.266 € | 4.057 € | | | |
| Medidas Measures Mesures (mm) | 1003 x 580 x 1110 mm. | 1354 x 580 x 1110 mm. | 1504 x 580 x 1110 mm. | 1384 x 740 x 1060 mm. | 2011 x 740 x 1060 mm. | | | |
| Temperatura Temperature Température (°C) | 3°C/+6°C | | | | | | | |
| Clase Climática Climatic class Classe climatique (°C) | 4 / 38°C | | | 4 / 38°C | | | | |
| Tensión/Frecuencia Electrical data Tension électrique | 230V/1ph/50Hz | | | | | | | |
| Controlador Controller Régulateur | Digital | | | | | | | |
| Material Material (EXT/INT) Matériel | Inox AISI 304 | | | | | | | |
| Espesor Thickness Épaisseur (mm) | 70 | | | | | | | |
| Aislamiento Isolation Isolation (mm) | 40kg/m ³ / Free CFC's / Zero ODP-GWP | | | | | | | |
| Capacidad Capacity Capacité (L) | 220 | 300 | 340 | 470 | 710 | | | |
| Superficie exposición Surface exhibition Surface d'exposition (m ²) | 0,36 | 0,50 | 0,56 | | | | | |
| Nº puertas / Estantes Doors / Shelving Nº de portes / Étagères | 2 / 2 | | | 2 / 2 | 3 / 2 | | | |
| Sistema de frío Cooling System Système de froid | Ventilado / Ventilated / Ventilé | | | Ventilado / Ventilated / Ventilé | | | | |
| Desescarche Defrost Dégivrage | Automático / Automatic / Automatique | | | Parada de compresor / Compressor off / Arrêt du compresseur | | | | |
| Expansión Expansion Expansion | Capilar / Capillary / Capillaire | | | Capilar / Capillary / Capillaire | | | | |
| Potencia Power Puissance (W) | 239 | 246 | 249 | 551 | 557 | | | |
| Potencia frig. Cooling capacity Puissance Frig. (W A -10°C) | - | | | 687 | | | | |
| Consumo Consumption Consommation (kWh/ 24h) | 3,4 | 3,54 | 3,6 | 8,6 | 9,7 | | | |
| Clase energética Energy class Classe Énerg. | | | | | | | | |
| Refrigerante Refrigerant Gaz | R-290 | | | | | | | |
| Opcional Optional Options | | | | Puerta de cristal Glass door (unit) Porte vitrée (unité) (Dcha.-Right-Droite) KPUIDVCCR 96 € (Izq.-Left-Gauche) KPUIVCCR | Estante de cristal Glass shelf (unit) Étagère vitrée (unité) (604V156) 24 € | Cerradura puerta ciega Solid door lock Serrure porte inox (506X120; 506X121) 42 € | Cerradura puerta cristal Glass door lock Serrure porte vitrée (506X60) 42 € | Opción color NEGRO Option BLACK color Couleur NOIR en option  400 € VC 1400 B 450 € VC 2010 B |

Serie / Series / Série **VMS / VC**

+Info: www.infrico.com

VC 2010 B



VMS 1000 I



VC 1400

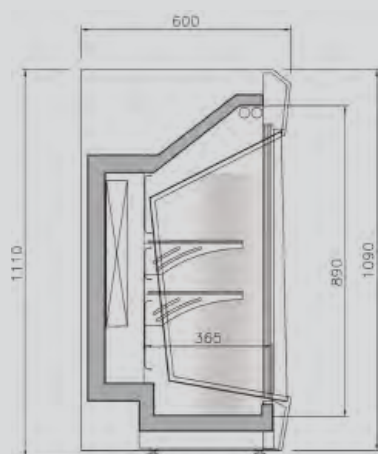

**Puertas traseras /
Back doors /
Portes arrières**





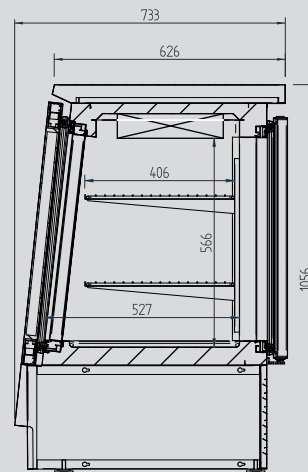

VC 2100



Vitrina expositora carro para pescado /
Fish display case /
Vitrine réfrigérée pour poisson sur roulettes

Vitrina expositora para pescado /
Fish display case /
Vitrine réfrigérée pour poisson

| MODELO MODELE MODÈLE | VRP  | VML 12  | VML 15  | VML 18  |
|---|--|--|--|--|
| Precio Price Prix | 3.123 € | 3.255 € | 3.554 € | 3.872 € |
| Medidas Measures Mesures (mm) | 1320 x 850 x 1275 mm. | 1330 x 900 x 1335 mm. | 1642 x 900 x 1335 mm. | 1955 x 900 x 1335 mm. |
| Temperatura Temperature Température (°C) | -1°C/+1°C | | | |
| Clase Climática Climatic class Classe climatique (°C) | 4 / 38°C | | | |
| Tensión/Frecuencia Electrical data Tension électrique | 230V/1ph/50Hz | | | |
| Controlador Controller Régulateur | Digital | | | |
| Material Material Matériel (EXT/INT) | Inox AISI 304 | | | |
| Espesor Thickness Épaisseur (mm) | 70 | | | |
| Aislamiento Isolation Isolation (mm) | 40kg/m ³ / Free CFC's / Zero ODP-GWP | | | |
| Capacidad Capacity Capacité (L) | 115 | 115 | 237 | 360 |
| Superficie exposición Surface exhibition Surface d'exposition (m ²) | 0,75 | 0,79 | 0,99 | 1,19 |
| Compresor Compressor Compresseur (HP) | 1/4 | 1/3 | 1/2 | 7/8 |
| Sistema de frío Cooling System Système de froid | Ventilado / Ventilated / Ventilé | | | |
| Desescarche Defrost Dégivrage | Manual / Manual / Manuel | | | |
| Expansión Expansion Expansion | Capilar / Capillary / Capillaire | | | |
| Potencia Power Puissance (W) | 475 | 410 | 410 | 520 |
| Potencia frig. Cooling capacity Puissance Frig. (W A -10°C) | - | | | |
| Consumo Consumption Consommation (kWh/ 24h) | 6,7 | 8,7 | 12,5 | 8,9 |
| Clase energética Energy class Classe Énerg. | | | | |
| Refrigerante Refrigerant Gaz | R-290a | | | |
| Opcional Optional Options | | Iluminación LED frontal Frontal LED lighting Éclairage LED frontale ILUDECVMB12 42 € | Iluminación LED frontal Frontal LED lighting Éclairage LED frontale ILUDECVMB15 51 € | Iluminación LED frontal Frontal LED lighting Éclairage LED frontale ILUDECVMB18 65 € |

Serie / Series / Série **VRP / VML MÁLAGA**

+Info: www.infrico.com

VRP 13



VML 18

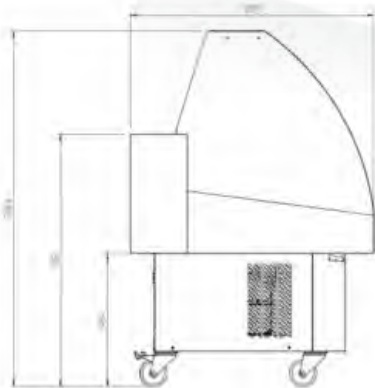



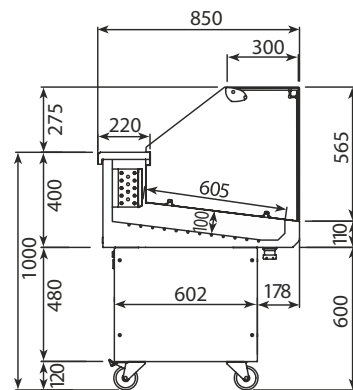







VML



VRP



Mueble caja mostrador / Counter case / Meuble caisse

| MODELO MODELE MODÈLE |  VJU 9 C |  VJU 12 C |  VJU 15 C |  VJU 18 C |  VJU 25 C |
|---|--|---|--|---|---|
| Precio Price Prix | 2.310 € | 2.621 € | 2.890 € | 3.227 € | 3.313 € |
| Medidas Measures Mesures (mm) | 944 x 979 x 1323 mm. | 1256 x 979 x 1323 mm. | 1568 x 979 x 1323 mm. | 1881 x 979 x 1323 mm. | 2506 x 979 x 1323 mm. |
| MODELO MODELE MODÈLE |  VJU 9 P |  VJU 12 P |  VJU 15 P |  VJU 18 P |  VJU 25 P |
| Precio Price Prix | 2.279 € | 2.598 € | 2.867 € | 3.198 € | 3.799 € |
| Medidas Measures Mesures (mm) | 944 x 979 x 1323 mm. | 1256 x 979 x 1323 mm. | 1568 x 979 x 1323 mm. | 1881 x 979 x 1323 mm. | 2506 x 979 x 1323 mm. |
| Temperatura Temperature Température (°C) | 3°C/+6°C | | | | |
| Clase Climática Climatic class (°C) Classe climatique | 4 / 38°C | | | | |
| Tensión/Frecuencia Electrical data Tension électrique | 230V/1ph/50Hz | | | | |
| Controlador Controller Régulateur | Digital | | | | |
| Material Material (EXT/INT) Matériel | Ext: Acero galvanizado / Galvanized steel / Acier galvanisée Int: PVC | | | | |
| Espesor Thickness Épaisseur (mm) | 50 | | | | |
| Aislamiento Isolation Isolation (mm) | 40kg/m ³ / Free CFC's / Zero ODP-GWP | | | | |
| Capacidad Capacity Capacité (L) | 200 | 262 | 324 | 387 | 512 |
| Superficie exposición Surface exhibition Surface d'exposition (m ²) | 0,50 | 0,70 | 0,9 | 1,0 | 1,4 |
| Nº puertas / Estantes Doors / Shelving Nº de portes / Étagères | 1 / 1 | 2 / 1 | 2 / 1 | 3 / 1 | 4 / 1 |
| Sistema de frío Cooling System Système de froid | Estático / Static / Statique | | | | |
| Desescarche Defrost Dégivrage | Automático / Automatic / Automatique | | | | |
| Expansión Expansion Expansion | Capilar / Capillary / Capillaire | | | | |
| Potencia Power Puissance (W) | 280 | 460 | 460 | 650 | 650 |
| Potencia frig. Cooling capacity Puissance Frig. (W A -10°C) | 370 | 687 | 687 | 951 | 951 |
| Consumo Consumption Consumation (kWh/ 24h) | - | | | | |
| Clase energética Energy class Classe Énerg. | - | | | | |
| Refrigerante Refrigerant Gaz | R-290 | | | | |
| Opcional Optional Options | 115V/1ph/60Hz Sin incremento/No increase/Pas d'augmentation 230V/1ph/60Hz Sin incremento/No increase/Pas d'augmentation | | | | |

Serie / Series / Série **JULIET**

+Info: www.infrico.com

Cristal panorámico sin marco
Panoramic frameless glass
Vitrage panoramique sans cadre

VJU 18 P



Laterales en acero
Sides steel
Joues en acier

Costados / Sides / Joues

Incluidos / Includes / Inclus

Ext. Estándar / Standar / Standard

| | | |
|------------------------|----------|----------------------|
| Blanco/White/ Blanc | Ral 1001 | Ral 1018 |
| Ral 3003 | Ral 3020 | Ral 2003 |
| Ral 5015 | Ral 5017 | Ral 5011 |
| Ral 6002 | Ral 6018 | Ral 6019 |
| Ral 7035 | Ral 7037 | Ral 7042 |
| Ral 7016 | Ral 9006 | Negro/Black/ Noir |







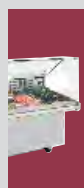



**Colores fuera de carta /
Colors outside of letter /
Couleurs spéciales, hors palette**

| RAL | | NO RAL | |
|--|--------------------------------|---|--------------------------------|
| Epoxi | Líquida/ Liquid/ Liquide | Epoxi | Líquida/ Liquid/ Liquide |
| 817 € | 508 € | Consultar / Consulter / Consulter | |
| [x unidad/x unit/x unité] | | | |
| +10 días laborables / +10 work days / +10 jours ouvrés | | Consultar / Consulter / Consulter | |

VJU 12 C



Vitrina expositora frío ventilado / Refrigerated whit storage display case / Vitrine de présentation non canalisable

| | | CRISTAL CURVO / CURVED GLASS / VITRE BOMBÉE | | | | | |
|---|-------------------|---|---|---|---|---|--|
| MODELO MODELE MODÈLE | |  VMB 9 RU/RIU |  VMB 12 RU/RIU |  VMB 15 RU/RIU |  VMB 18 RU/RIU |  VMB 25 RU/RIU | |
| Precio Price Prix | RU RIU | 2.715 € 2.793 € | 3.025 € 3.190 € | 3.428 € 3.563 € | 3.932 € 4.149 € | 4.850 € 5.005 € | |
| Medidas Measures Mesures | (mm) | 998 x 953 x 1300 mm. | 1310 x 953 x 1300 mm. | 1622 x 953 x 1300 mm. | 1935 x 953 x 1300 mm. | 2560 x 953 x 1300 mm. | |
| MODELO MODELE MODÈLE | |  VMB 9 RUP/RIUP |  VMB 12 RUP/RIUP |  VMB 15 RUP/RIUP |  VMB 18 RUP/RIUP |  VMB 25 RUP/RIUP | |
| Precio Price Prix | RUP RIUP | 2.664 € 2.817 € | 3.023 € 3.217 € | 3.488 € 3.602 € | 3.999 € 4.146 € | 4.880 € 5.011 € | |
| Medidas Measures Mesures | (mm) | 998 x 953 x 1315 mm. | 1310 x 953 x 1315 mm. | 1622 x 953 x 1315 mm. | 1935 x 953 x 1315 mm. | 2560 x 953 x 1315 mm. | |
| Temperatura Temperature Température | (°C) | 0°C/+6°C | | | | | |
| Clase Climática Climatic class Classe climatique | (°C) | 4 / 38°C | | | | | |
| Tensión/Frecuencia Electrical data Tension électrique | | 230V/1ph/50Hz | | | | | |
| Controlador Controller Régulateur | | Digital | | | | | |
| Material Material Matériel | (EXT/INT) | Acero plastificado / Plastic-coated steel / Acier plastifié Inox AISI 304 | | | | | |
| Costados Sides Joues | (mm) | 30 + 30 | | | | | |
| Aislamiento Isolation Isolation | (mm) | 40kg/m ³ / Free CFC's / Zero ODP-GWP | | | | | |
| Capacidad Capacity Capacité | (L) | 144 | 191 | 239 | 287 | 382 | |
| Superficie exposición Surface exhibition Surface d'exposition | (m ²) | 0,66 | 1,08 | 1,35 | 1,63 | 2,18 | |
| Compresor Compressor Compresseur | (HP) | 1/3 | 3/8 | 5/8 | 3/4 | 1 | |
| Sistema de frío Cooling System Système de froid | | Ventilado / Ventilated / Ventilé | | | | | |
| Desescarche Defrost Dégivrage | | Automático / Automatic / Automatique | | | | | |
| Expansión Expansion Expansion | | Ventilado / Ventilated / Ventilé | | | | | |
| Potencia Power Puissance | (W) | 380 | 384 | 523 | 573 | 670 | |
| Potencia frig. Cooling capacity Puissance Frig. | (W A -10°C) | - | | | | | |
| Consumo Consumption Consommation | (kWh/ 24h) | 5,9 | 6,1 | 7,6 | 8,3 | 9,7 | |
| Refrigerante Refrigerant Gaz | | R-290a | | | | | |
| Opcional Optional Options | | Puertas correderas traseras / Rear sliding doors / Portes coulissantes arrière VMB PUEVMB9CT 72 € PUEVMB12CT 88 € PUEVMB15CT 110 € PUEVMB18CT 128 € PUEVMB25CT 159 € | | VMB P PUEVMB9CTCP 69 € PUEVMB12CTCP 105 € PUEVMB15CTCP 124 € PUEVMB18CTCP 121 € PUEVMB25CTCP 193 € | | Luz LED deco. frontal / Frontal deco. LED lighting / Éclair. LED deco. frontale ILUDECVMBC9 34 € ILUDECVMBC12 42 € ILUDECVMBC15 51 € Luz LED estante / LED lighting shelf / Éclairage LED étagère ILUESTVMBC9 34 € ILUESTVMBC12 42 € ILUESTVMBC15 51 € | ILUDECVMBC18 65 € ILUDECVMBC25 84 € ILUESTVMBC18 65 € ILUESTVMBC25 84 € |

Serie / Series / Série **MARBELLA**

+Info: www.infrico.com

VMB 15 RU



Ext. Estándar / Standar / Standard

| | | |
|------------------------|----------|----------------------|
| Blanco/White/ Blanc | Ral 1001 | Ral 1018 |
| Ral 3003 | Ral 3020 | Ral 2003 |
| Ral 5015 | Ral 5017 | Ral 5011 |
| Ral 6002 | Ral 6018 | Ral 6019 |
| Ral 7035 | Ral 7037 | Ral 7042 |
| Ral 7016 | Ral 9006 | Negro/Black/ Noir |

Colores fuera de carta /
Colors outside of letter /
Couleurs spéciales, hors palette

| RAL | | NO RAL | |
|--|--------------------------------|---|--------------------------------|
| Epoxi | Líquida/ Liquid/ Liquide | Epoxi | Líquida/ Liquid/ Liquide |
| 817 € | 508 € | Consultar / Consultar / Consulter | |
| [x unidad/x unit/x unité] | | | |
| +10 días laborables / +10 work days / +10 jours ouvrés | | Consultar / Consultar / Consulter | |



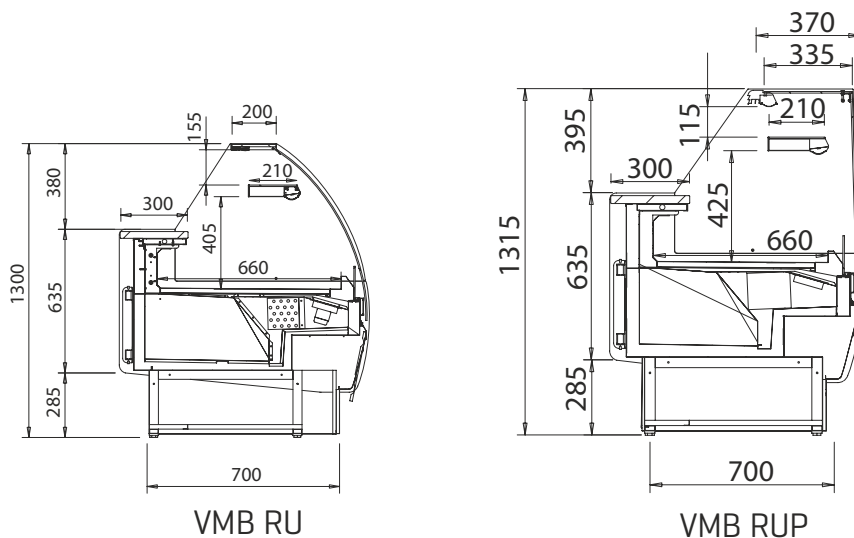

VMB 25 RUP



VMB RU

VMB RUP

Vitrina expositora frío ventilado con reserva / Refrigerated whit storage display case / Vitrine de présentation avec réserve non canalisable

| MODELO MODELE MODÈLE |  |  |  |  |  | |
|---|---|--|--|---|---|------|
| | VMC 9 RU/RIU | VMC 12 RU/RIU | VMC 15 RU/RIU | VMC 18 RU/RIU | VMC 25 RU/RIU | |
| Precio Price Prix | RU 2.806 € | 3.175 € | 3.593 € | 4.128 € | 5.048 € | |
| | RIU 2.854 € | 3.254 € | 3.705 € | 4.275 € | 5.561 € | |
| Medidas Measures Mesures | (mm) 998 x 1103 x 1300 mm. | 1310 x 1103 x 1300 mm. | 1622 x 1103 x 1300 mm. | 1935 x 1103 x 1300 mm. | 2560 x 1103 x 1300 mm. | |
| Temperatura Temperature Température | (°C) | 0°C/+6°C | | | | |
| Clase Climática Climatic class Classe climatique | (°C) | 4 / 38°C | | | | |
| Tensión/Frecuencia Electrical data Tension électrique | | 230V/1ph/50Hz | | | | |
| Controlador Controller Régulateur | | Digital | | | | |
| Material Material Matériel | [EXT/INT] | Acero plastificado / Plastic-coated steel / Acier plastifié Inox AISI 304 | | | | |
| Costados Sides Joues | (mm) | 30 + 30 | | | | |
| Aislamiento Isolation Isolation | (mm) | 40kg/m ³ / Free CFC's / Zero ODP-GWP | | | | |
| Capacidad Capacity Capacité | [L] | 205 | 274 | 342 | 411 | 548 |
| Superficie exposición Surface exhibition Surface d'exposition | [m ²] | 0,82 | 1,09 | 1,36 | 1,63 | 2,18 |
| Compresor Compressor Compresseur | [HP] | 1/3 | 3/8 | 5/8 | 3/4 | 1 |
| Sistema de frío Cooling System Système de froid | | Ventilado / Ventilated / Ventilé | | | | |
| Desescarche Defrost Dégivrage | | Automático / Automatic / Automatique | | | | |
| Expansión Expansion Expansion | | Ventilado / Ventilated / Ventilé | | | | |
| Potencia Power Puissance | [W] | 380 | 384 | 523 | 573 | 670 |
| Potencia frig. Cooling capacity Puissance Frig. | [W A -10°C] | | | - | | |
| Consumo Consumption Consommation | [kWh/ 24h] | 5,9 | 6,1 | 7,6 | 8,3 | 9,7 |
| Clase energética Energy class Classe Énerg. | | - | | | | |
| Refrigerante Refrigerant Gaz | | R-290a | | | | |
| Opcional Optional Options | | <p>Puertas correderas traseras / Rear sliding doors / Portes coulissantes arrière</p> <p>PUEVMC9CT 79 € PUEVMC12CT 119 € PUEVMC15CT 122 € PUEVMC18CT 141 € PUEVMC25CT 221 €</p> <p>Luz LED deco. frontal / Frontal deco. LED lighting / Éclair. LED deco. frontale</p> <p>ILUDECVMBC9 34 € ILUDECVMBC12 42 € ILUDECVMBC15 51 €</p> <p>ILUDECVMBC18 65 € ILUDECVMBC25 84 €</p> <p>Luz LED estante / LED lighting shelf / Éclairage LED étagère</p> <p>ILUESTVMBC9 34 € ILUESTVMBC12 42 € ILUESTVMBC15 51 €</p> <p>ILUESTVMBC18 65 € ILUESTVMBC25 84 €</p> | | | | |

Serie / Series / Série **MALLORCA**

+Info: www.infrico.com

VMC 18 RU



VMC 12 RU



Ext. Estándar / Standar / Standard

| | | |
|--------------------|----------|------------------|
| Blanco/White/Blanc | Ral 1001 | Ral 1018 |
| Ral 3003 | Ral 3020 | Ral 2003 |
| Ral 5015 | Ral 5017 | Ral 5011 |
| Ral 6002 | Ral 6018 | Ral 6019 |
| Ral 7035 | Ral 7037 | Ral 7042 |
| Ral 7016 | Ral 9006 | Negro/Black/Noir |

Colores fuera de carta / Colors outside of letter / Couleurs spéciales, hors palette

| RAL | | NO RAL | |
|--|--------------------------------|---|--------------------------------|
| Epoxi | Líquida/ Liquid/ Liquide | Epoxi | Líquida/ Liquid/ Liquide |
| 817 € | 508 € | Consultar / Consultar / Consulter | |
| [x unidad/x unit/x unité] | | | |
| +10 días laborables / +10 work days / +10 jours ouvrés | | Consultar / Consultar / Consulter | |

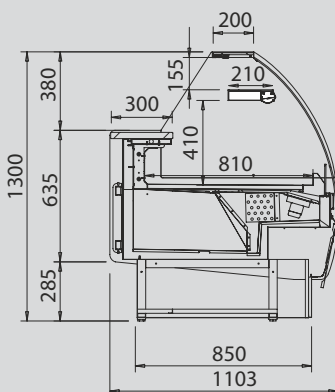

VMC RU

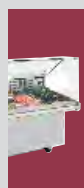
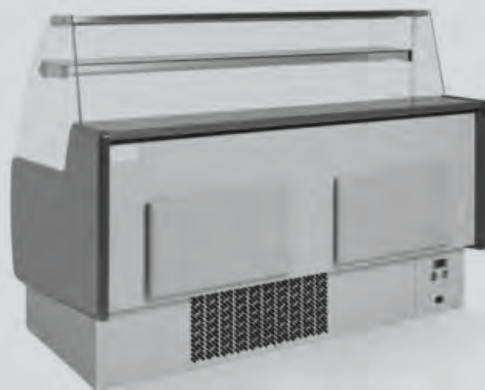

Mueble caja mostrador / Counter case / Meuble caisse



VMB 9 C



VMB 12 M

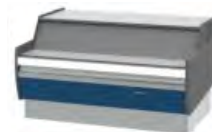

VMB 15 M

| MODELO MODELE MODÈLE | VMB 9 C | VMB 12 M | VMB 15 M |
|--|---------------------|----------------------|----------------------|
| Precio Price Prix | 1.374 € | 1.423 € | 1.593 € |
| Medidas Measures Mesures [mm] | 998 x 953 x 920 mm. | 1310 x 953 x 920 mm. | 1622 x 953 x 920 mm. |
| Temperatura Temperature Température [°C] | - | | |
| Clase Climática Climatic class Classe climatique [°C] | - | | |
| Tensión/Frecuencia Electrical data Tension électrique | 230V/1ph/50Hz | | |
| Superficie exposición Surface exhibition Surface d'exposition [m ²] | 0,62 | 0,83 | 1,03 |
| Potencia Power Puissance [W] | - | | |

Mueble caja mostrador / Counter case / Meuble caisse

Serie / Series / Série **MALLORCA**



VMC 9 C

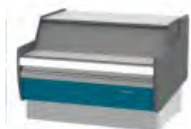

VMC 12 M

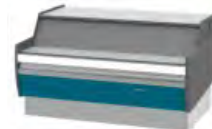

VMC 15 M

| MODELO MODELE MODÈLE | VMC 9 C | VMC 12 M | VMC 15 M |
|--|----------------------|-----------------------|-----------------------|
| Precio Price Prix | 1.139 € | 1.284 € | 1.453 € |
| Medidas Measures Mesures [mm] | 998 x 1103 x 920 mm. | 1310 x 1103 x 920 mm. | 1622 x 1103 x 920 mm. |
| Temperatura Temperature Température [°C] | - | | |
| Clase Climática Climatic class Classe climatique [°C] | - | | |
| Tensión/Frecuencia Electrical data Tension électrique | 230V/1ph/50Hz | | |
| Superficie exposición Surface exhibition Surface d'exposition [m ²] | 0,55 | 0,74 | 0,94 |
| Potencia Power Puissance [W] | - | | |

Serie / Series / Série **MARBELLA**

+Info: www.infrico.com

VMB 9 C



VMB 12 C



VMC 12 M



VMC 15 M

Ext. Estándar / Standar / Standard

| | | |
|------------------------|----------|----------------------|
| Blanco/White/ Blanc | Ral 1001 | Ral 1018 |
| Ral 3003 | Ral 3020 | Ral 2003 |
| Ral 5015 | Ral 5017 | Ral 5011 |
| Ral 6002 | Ral 6018 | Ral 6019 |
| Ral 7035 | Ral 7037 | Ral 7042 |
| Ral 7016 | Ral 9006 | Negro/Black/ Noir |

**Colores fuera de carta /
Colors outside of letter /
Couleurs spéciales, hors palette**

| RAL | | NO RAL | |
|--|--------------------------------|---|--------------------------------|
| Epoxi | Líquida/ Liquid/ Liquide | Epoxi | Líquida/ Liquid/ Liquide |
| 817 € | 508 € | Consultar / Consulter / Consulter | |
| [x unidad/x unit/x unité] | | | |
| +10 días laborables / +10 work days / +10 jours ouvrés | | Consultar / Consulter / Consulter | |

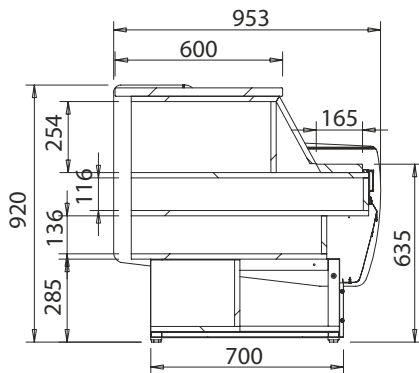

VMB M

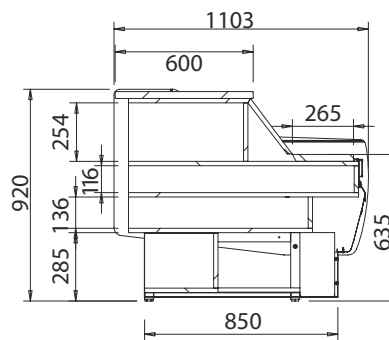

VMC M



PHOTOBOOK



+Info: www.infrico.com

osmarc.es



Super market





 Infrico



Waterin

Sistema Waterloop **R290** de Infrico

270-273

Serie / Series / Série

VMD Madrid



VMD R/S
VMD R/S Ángulos/Angles/Angles
VMD C / M _____ 274-281

Serie / Series / Série

VBC Barcelona



VBC R/S
VBC R/S Ángulos/Angles/Angles
VBC C / M / MHD
VBC R/S CP
VBC R/S CP Ángulos/Angles/Angles
VBC CP / MP / MHDP
VBC S CB _____ 282-303

Serie / Series / Série

VEX Experience

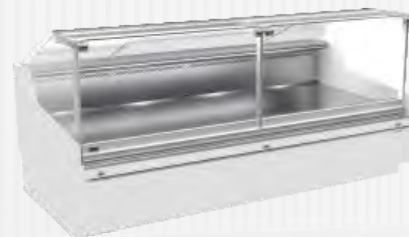

VEX CP
VEX
VEX CB
VEX Ángulos/Angles/Angles
VEX CA / CP HT _____ 304-317

Serie / Series / Série

VEE California



VEE
VEE CA
VEE HT
VEE GC
VEE S
VEE AAM _____ 318-325

Serie / Series / Série

Visión



SVS
VVS
VCD
VVL _____ 326-327

Serie / Series / Série

GD/COMBI



GD P
AS25U _____ 328-331



9. Supermarket

Estructura de cristales de alta transparencia, rectos o curvos según modelo.

High transparency glass structure, flat or curved depending on the model.

Structure en verre à haute transparence, droite ou bombée selon le modèle.

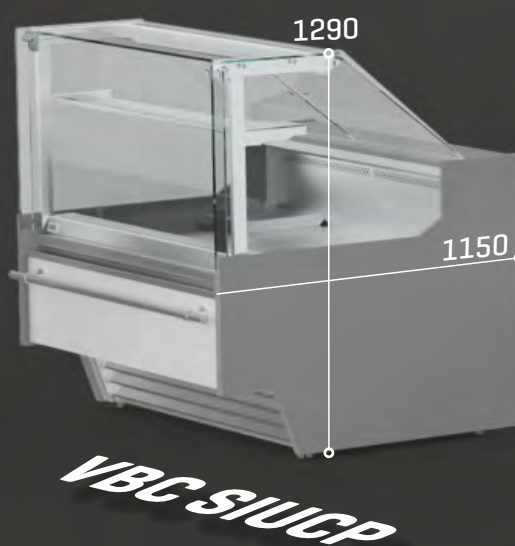
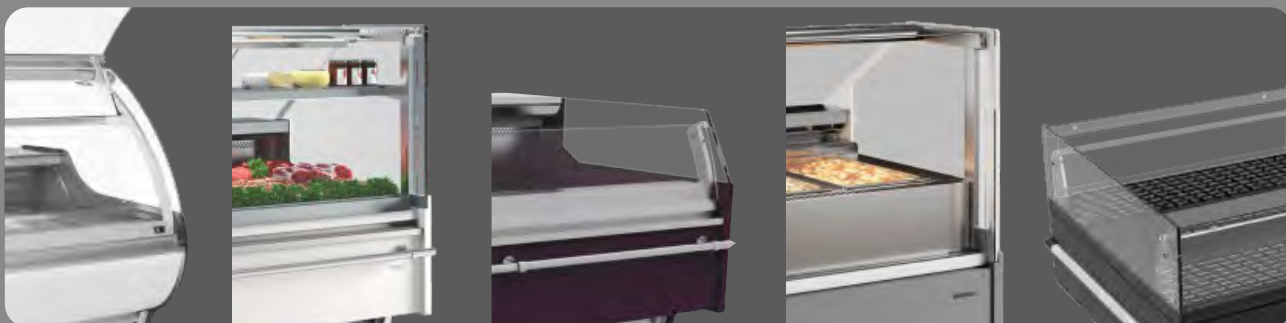

Iluminación / Lighting / Éclairage

Incorporación de iluminación LED, llegando a reducir el consumo energético entre un 80% y 90%, respecto a una bombilla tradicional.

LED lighting incorporated, reducing energetic consumption between 80% and 90% respect to a traditional lighth bulb.

Éclairage LED, réduisant la consommation énergétique entre 80% et 90%, par rapport à une ampoule traditionnelle.



Equipos con posibilidad de grupo remoto y grupo incorporado.

Devices with the possibility of remote group and integrated group.

Équipement avec la possibilité de groupe à distance et de groupe incorporé.



Máxima visibilidad de producto expuesto.

Maximum visibility of displayed product.

Visibilité maximale du produit exposé.



Amplia gama de opciones y posibilidades de personalización para exponer todo tipo de productos refrigerados sin envasar: carne, charcutería y delicatessen.

Wide range of options and customisation possibilities for displaying all types of unpackaged refrigerated products: meat, deli and delicatessen.

Nombreuses options et possibilités de personnalisation pour présenter tous les types de produits réfrigérés non emballés : viande, charcuterie et delicatessen.



Waterin

Sistema Waterloop R290 de Infrico

hasta
-25%

Sistema eficiente, hasta el 25% de ahorro de energía.
Efficient system with up to 25% energy saving.
Système efficace avec jusqu'à 25 % d'économies d'énergie.

-75%

75% reducción carga refrigerante.
75% refrigerant charge reduction.
Réduction de 75 % de la charge de réfrigérant.

0€

Refrigerantes naturales SIN TASA.
Natural refrigerants WITHOUT CHARGE.
Réfrigérateurs naturels SANS TÂCHE.



Mínima carga refrigerante, aprox. 0.1kg/kw.
Minimum refrigerant load, aprox. 0.1kg/kw.
Charge minimale de réfrigérant, avec environ 0,1 Kg/kw de réfrigération.



Flexibilidad de implantación.
Flexibility of implementation.
Flexibilité de mise en oeuvre.



Posibilidad de recuperación de calor en la instalación.
Possibility of heat recovery in the installation.
Possibilité de récupération de chaleur dans l'installation.



Condensadores sin mantenimiento.
Maintenance-free condensers.
Condensateurs de maintenance.



Posible eliminación de la sala de máquinas.
Possible elimination of the machine room.
Élimination possible, dans de nombreux cas, de la salle des machines.



Eliminación de riesgos típicos de inst. centralizadas.
Elimination of the typical risks of central installations.
Élimination des risques typiques des installations centralisées.



Menor riesgo de fugas.
Reduced risk of leakage.
Moins de risques de fuites.



El ahorro energético y el cuidado del medio ambiente son dos factores claves que han impulsado la iniciativa Waterin.

¿Qué es Waterin?

Waterin son muebles de refrigeración comercial para la conservación de productos refrigerados y congelados, con unidades individuales R290 y sistema de condensación por agua.

¿Dónde podemos instalar este sistema?

Este sistema es óptimo para instalaciones que cumplan los siguientes condicionantes:

- Sala de ventas de hasta 1400m² con aproximadamente hasta 40kW frigoríficos.
- Temperatura de trabajo exterior (DryCooler) máxima de 48°C.

¿Este nuevo sistema requiere un proyecto de instalación?

El sistema Waterin no requiere instalación frigorífica porque son muebles con la unidad ya instalada y cargada desde fábrica, aunque su implantación requiere un cálculo de instalación para el dimensionado de las tuberías de agua, el DryCooler, el sistema hidráulico necesarios y su ubicación, etc.

Beneficios del sistema Waterin

Waterin por ser un sistema ecológico y de condensación por agua ofrece múltiples beneficios en la refrigeración comercial. Mayor eficiencia energética, menor impacto ambiental y mejor control de temperatura son sólo algunas de sus ventajas.



Saving energy and respect for the environment are two key factors that have driven the Waterin initiative.

What's Waterin?

Waterin are commercial refrigeration display cases for the preservation of refrigerated and frozen products, with individual R290 units and water condensation system.

Where do we install this system?

This system is ideal for installations that meet the following conditions:

- Supermarkets up to 1400m² with approximately up to 40kW of refrigeration capacity.
- Outdoor working temperature (DryCooler) max. 48°C.

Is an installation project required?

The Waterin system doesn't require refrigeration installation because it's display cases with the unit already installed and loaded from the factory, although its implementation requires an installation calculation for the dimensioning of the water pipes, the DryCooler, the necessary hydraulic system and its location, etc.

Benefits of Waterin

Waterin is an environmentally friendly, water condensing system that offers multiple benefits in commercial refrigeration. Greater energy efficiency, lower environmental impact and better temperature control are just some of its advantages.



Les économies d'énergie et le respect de l'environnement sont deux facteurs qui ont motivé l'initiative Waterin.

Qu'est-ce que Waterin?

Waterin est une armoire de réfrigération commerciale pour les températures positives et négatives de stockage des produits, avec des unités R290 individuelles et un système de condensation à l'eau.

Où peut-on installer ce système?

Ce système est optimal pour les installations qui répondent aux conditions suivantes :

- Salle de vente jusqu'à 1400 m² avec environ jusqu'à 40kW d'unités de réfrigération
- Température extérieure de travail (DryCooler) maximale de 48°C.

Ce nouveau système nécessite-t-il un projet d'installation?

Le système Waterin ne nécessite pas d'installation frigorifique car il s'agit d'un meuble avec l'unité déjà installée et chargée en usine, bien que sa mise en œuvre dans la salle de vente nécessite un calcul de l'installation du système de condensation de l'eau et de ses composants.

Quels sont les avantages du système Waterin ?

Waterin est un système écologique à condensation par eau qui offre de multiples avantages dans le domaine de la réfrigération commerciale. Une meilleure efficacité énergétique, un impact environnemental réduit et un meilleur contrôle de la température ne sont que quelques-uns de ses avantages.



Waterin

Sistema Waterloop R290 de Infrico

Unidades R290 condensados por agua de Temperatura Positiva.
R290 units, Positive Temperature water condensed.
Unités R290 à condensation par eau à Température Positive.

Unidades R290 condensados por agua de Temperatura Negativa.
R290 units, Negative Temperature water condensed.
Unités R290 à condensation par eau à Température négative.



Posibilidad de recuperación de calor para calefacción o agua caliente sanitaria.

Possibility of heat recovery for heating or sanitary hot water.

Possibilité de récupération de chaleur pour le chauffage ou l'eau chaude sanitaire.

Unidades R290 condensados por agua de Temperatura Positiva.
R290 units, Positive Temperature water condensed.
Unités R290 à condensation par eau à Température Positive.

9



VEXW

VEX (9-12-18-25-31-37) W-IW
VEX (9-12-18-25-31-37) WCP-IWCP
VEX (9-12-15-18-25) WCB-IWCB
VEX (90) AAW-ACW-AIW-ACIW
VEX (45) ACW-ACIW
VEX (90) AAWCP-ACWCP-AAIWCP-ACIWCP
VEX (45) ACWCP-ACIWCP



GDW

GD25WL1
GD21WL1
GDCWL1

Dry Coolers con grupo hidráulico.
 Dry Coolers with hydraulic power unit.
 Dry Coolers avec unité hydraulique.

Unidades R290 condensados por agua de Temperatura Negativa.
 R290 units, Negative Temperature water condensed.
 Unités R290 à condensation par eau à Température négative.

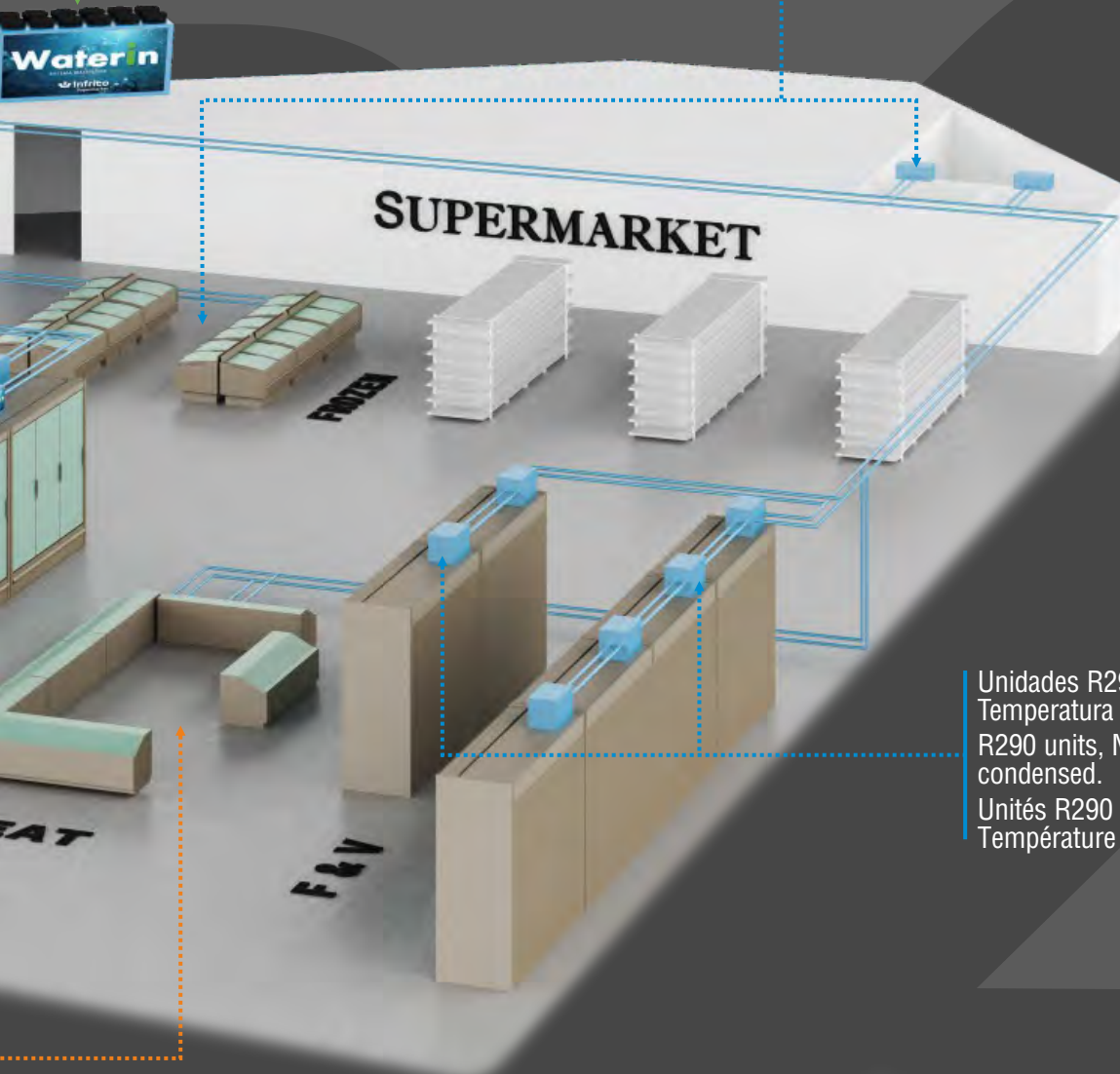















Unidades R290 condensados por agua de Temperatura Negativa.
 R290 units, Negative Temperature water condensed.
 Unités R290 à condensation par eau à Température négative.



AS25WL1

AS25W

Vitrina expositora modular frío ventilado grupo incorporado / Refrigerated modular plugin display case / Vitrine présentation froid ventilé canalisable groupe incorporé

| | | CON RESERVA / WHIT STORAGE / AVEC RÉSERVE - RIU: Plano Inox / Stainless Steel exhibition plan / Plan d'exposition Inox | | | | | | | | | | | | |
|---|--|--|---|---|---|---|---|---|--------------|----------------|--------------|----------------|--------------|--------------|
| | |  |  |  |  |  |  |  | | | | | | |
| MODELO MODELE MODÈLE | | VMD 9 RU/RIU | VMD 12 RU/RIU | VMD 15 RU/RIU | VMD 18 RU/RIU | VMD 25 RU/RIU | VMD 31 RU/RIU | VMD 37 RU/RIU | | | | | | |
| Precio Price Prix | RU | 3.087 € | 3.534 € | 3.838 € | 4.275 € | 5.414 € | 6.468 € | 7.256 € | | | | | | |
| | RIU | 3.176 € | 3.653 € | 3.992 € | 4.460 € | 5.662 € | 6.785 € | 7.635 € | | | | | | |
| | | SIN RESERVA / WHITOUT STORAGE / SANS RÉSERVE - SIU: Plano Inox / Stainless Steel exhibition plan / Plan d'exposition Inox | | | | | | | | | | | | |
| | |  |  |  |  |  |  |  | | | | | | |
| MODELO MODELE MODÈLE | | VMD 9 SU/SIU | VMD 12 SU/SIU | VMD 15 SU/SIU | VMD 18 SU/SIU | VMD 25 SU/SIU | VMD 31 SU/SIU | VMD 37 SU/SIU | | | | | | |
| Precio Price Prix | SU | 3.051 € | 3.427 € | 3.743 € | 4.109 € | 5.204 € | 6.281 € | 6.951 € | | | | | | |
| | SIU | 3.164 € | 3.579 € | 3.929 € | 4.331 € | 5.497 € | 6.659 € | 7.404 € | | | | | | |
| Medidas Mesures Mesures | (mm) | 938 x 1150 x 1290 mm. | 1250 x 1150 x 1290 mm. | 1562 x 1150 x 1290 mm. | 1875 x 1150 x 1290 mm. | 2500 x 1150 x 1290 mm. | 3125 x 1150 x 1290 mm. | 3750 x 1150 x 1290 mm. | | | | | | |
| Temperatura Temperature Température | (°C) | 0°C/+6°C | | | | | | | | | | | | |
| Clase Climática Climatic class Classe climatique | (°C) | 4 / 30°C | | | | | | | | | | | | |
| Tensión/Frecuencia Electrical data Tension électrique | | 230V/1ph/50Hz | | | | | | | | | | | | |
| Controlador Controller Régulateur | | Digital | | | | | | | | | | | | |
| Material Matériel Matériel | [EXT/INT] | Ext: acero plastificado / Plastified stainless steel / Acier plastifié Encimera / Worktop / Dessous: Inox Aisi 304 Plano exposición / Exhibition plan / Plan d'exposition: Acero plastif. / Plastif. Stainless steel/ Acier plastifié [Mod RU/SU] - Inox Aisi 304 [Mod. RIU/SIU] | | | | | | | | | | | | |
| Aislamiento Isolation Isolation | (mm) | 40kg/m ³ / Free CFC's / Zero ODP-GWP | | | | | | | | | | | | |
| Capacidad Capacity Capacité | (L) | 124 | 165 | 206 | 248 | 330 | 413 | 495 | | | | | | |
| Superficie exposición Surface exhibition Surface d'exposition | (m ²) | 0,96 | 1,28 | 1,59 | 1,91 | 2,55 | 3,19 | 3,83 | | | | | | |
| Compresor Compressor Compresseur | (HP) | 1/3 | 1/3 | 1/2 | 3/4 | 1 | 3/4 | 3/4 | | | | | | |
| Estantes Shelving Étagères | | 1 | | | | | | | | | | | | |
| Costados (2) Sides (2) Joues (2) | (mm) | 30+30 | | | | | | | | | | | | |
| Sistema de frío Cooling System Système de froid | | Ventilado / Ventilated / Ventilé | | | | | | | | | | | | |
| Desescarche Defrost Dégivrage | | Automático / Automatic / Automatique | | | | | | | | | | | | |
| Evaporación Evaporation Évaporation | | Forzada / Forced / Ventilé | | | | | | | | | | | | |
| Potencia Power Puissance | (W) | 385 | 395 | 530 | 581 | 767 | 1324 | 1341 | | | | | | |
| Potencia frig. Cooling capacity Puissance Frig. | (W A -10°C) | - | - | - | - | - | - | - | | | | | | |
| Consumo Consumption Consommation | (kWh/ 24h) | 4.61 | 4.74 | 6.36 | 6.98 | 9.21 | 15.9 | 16.1 | | | | | | |
| Refrigerante Refrigerant | | R-290 | | | | | | | | | | | | |
| Opcional Options | Puertas correderas traseras / Rear sliding doors / Portes coulissantes arrière | | | | | | | | | | | | | |
| | (PUEV9CT) | 58 € | (PUEV12CT) | 70 € | (PUEV15CT) | 87 € | (PUEV18CT) | 99 € | (PUEV25CT) | 124 € | (PUEV31CT) | 158 € | (PUEV37CT) | 174 € |
| | Cortinas traseras nocturnas / Night curtains / Rideaux de nuit | | | | | | | | | | | | | |
| | (CCNV9) | 140 € | (CCNV12) | 149 € | (CCNV15) | 180 € | (CCNV18) | 233 € | (CCNV25) | 299 € | (CCNV31) | 359 € | (CCNV37) | 467 € |
| | Doble plano (sin reserva) / Double surface (without storage) / Double plan (sans réserve) - / INOX | | | | | | | | | | | | | |
| (DPEXVMDBC9S) | 69 € | (DPEXVMDBC12S) | 92 € | (DPEXVMDBC15S) | 116 € | (DPEXVMDBC18S) | 139 € | (DPEXVMDBC25S) | 185 € | (DPEXVMDBC31S) | 231 € | (DPEXVMDBC37S) | 277 € | |
| (DPEXVMD9SI) | 152 € | (DPEXVMD12SI) | 203 € | (DPEXVMD15SI) | 253 € | (DPEXVMD18SI) | 303 € | (DPEXVMD25SI) | 405 € | (DPEXVMD31SI) | 506 € | (DPEXVMD37SI) | 608 € | |

Laterales no incluidos en el precio
Side panels not included in price
Joues non incluses dans le prix

VMD 25 RU



Detalle reserva
Storage detail
Détail réserve

Laterales / Sides / Joues

| NO | |
|-----------------------------|----------------------------|
| Izquierdo Left Gauche | Derecho Right Droite |
| 266 € | 266 € |



VMD 18 SU

Ext. Estándar / Standar / Standard

| | | |
|------------------------|----------------|----------------|
| Blanco/White/ Blanc | Ral 1001 | Ral 1018 |
| Ral 2003 | Ral 3003 | Ral 3020 |
| Design 2108025 | Ral 5015 | Ral 4007 |
| Ral 6002 | Design 1107060 | Design 3504035 |
| Ral 9006 | Ral 7016 | Ral 8017 |

**Colores fuera de carta /
Colors outside of letter /
Couleurs spéciales, hors palette**

| RAL | | NO RAL | |
|--|--------------------------------|---|--------------------------------|
| Epoxi | Líquida/ Liquid/ Liquide | Epoxi | Líquida/ Liquid/ Liquide |
| 817 € | 508 € | Consultar / Consulter / Consulter | |
| [x unidad/x unit/x unité] | | | |
| +10 días laborables / +10 work days / +10 jours ouvrés | | Consultar / Consulter / Consulter | |

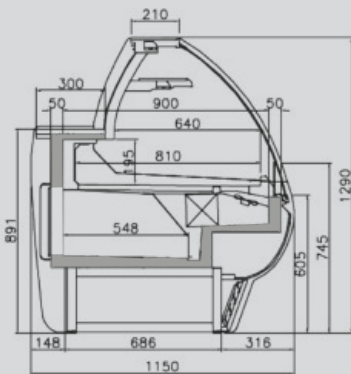



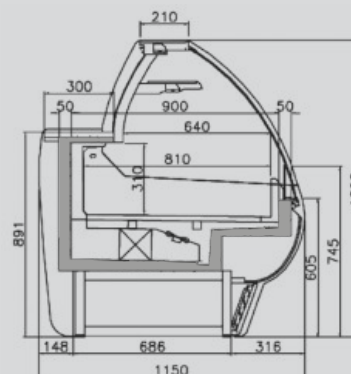



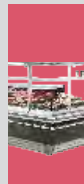







VMD R (con reserva)
[Whit storage]
[Avec réserve]



VMD S (Sin reserva)
[Whitout storage]
[Sans réserve]



Vitrina expositora modular frío ventilado grupo remoto / Refrigerated modular display remote case / Vitrine présentation froid ventilé canalisable groupe à distance

| | | CON RESERVA / WHIT STORAGE / AVEC RÉSERVE - RI: Plano Inox / Stainless Steel exhibition plan / Plan d'exposition Inox | | | | | | |
|---|---------------------------|--|---|---|---|---|---|---|
| MODELO MODELE MODÈLE | |  VMD 9 R/RI |  VMD 12 R/RI |  VMD 15 R/RI |  VMD 18 R/RI |  VMD 25 R/RI |  VMD 31 R/RI |  VMD 37 R/RI |
| Precio Price Prix | R | 2.885 € | 3.333€ | 3.578 € | 4.015 € | 5.074 € | 5.871 € | 6.658 € |
| | RI | 2.975 € | 3.451 € | 3.733 € | 4.201 € | 5.321 € | 6.188 € | 7.037 € |
| | | SIN RESERVA / WHITOUT STORAGE / SANS RÉSERVE - SI: Plano Inox / Stainless Steel exhibition plan / Plan d'exposition Inox | | | | | | |
| MODELO MODELE MODÈLE | |  VMD 9 S/SI |  VMD 12 S/SI |  VMD 15 S/SI |  VMD 18 S/SI |  VMD 25 S/SI |  VMD 31 S/SI |  VMD 37 S/SI |
| Precio Price Prix | S | 2.850 € | 3.226 € | 3.484 € | 3.849 € | 4.864 € | 5.684 € | 6.354 € |
| | SI | 2.962 € | 3.378 € | 3.670 € | 4.072 € | 5.157 € | 6.062 € | 6.806 € |
| Medidas Measures Mesures | (mm) | 938 x 1150 x 1290 mm. | 1250 x 1150 x 1290 mm. | 1562 x 1150 x 1290 mm. | 1875 x 1150 x 1290 mm. | 2500 x 1150 x 1290 mm. | 3125 x 1150 x 1290 mm. | 3750 x 1150 x 1290 mm. |
| Temperatura Temperature Température | (°C) | 0°C/+6°C | | | | | | |
| Clase Climática Climatic class Classe climatique | (°C) | 4 / 30°C | | | | | | |
| Tensión/Frecuencia Electrical data Tension électrique | | 230V/1ph/50Hz | | | | | | |
| Controlador Controller Régulateur | | Digital | | | | | | |
| Material Matériel | [EXT/INT] | Ext: acero plastificado / Plastified stainless steel / Acier plastifié Encimera / Worktop / Dessous: Inox Aisi 304 Plano exposición / Exhibition plan / Plan d'exposition: Acero plastif./Plastif. Stainless steel/ Acier plastifié [Mod R/S] - Inox Aisi 304 [Mod. RI/SI] | | | | | | |
| Aislamiento Isolation Isolation | (mm) | 40kg/m ³ / Free CFC's / Zero ODP-GWP | | | | | | |
| Capacidad Capacity Capacité | (L) | 124 | 165 | 206 | 248 | 330 | 413 | 495 |
| Superficie exposición Surface exhibition Surface d'exposition | (m ²) | 0,96 | 1,28 | 1,59 | 1,91 | 2,55 | 3,19 | 3,83 |
| Compresor Compressor Compresseur | (HP) | - | - | - | - | - | - | - |
| Estantes Shelving Étagères | | 1 | | | | | | |
| Costados (2) Sides (2) Joues (2) | (mm) | 30+30 | | | | | | |
| Sistema de frío Cooling System Système de froid | | Ventilado / Ventilated / Ventilé | | | | | | |
| Desescarche Defrost Dégivrage | | Automático / Automatic / Automatique | | | | | | |
| Evaporación Evaporation Évaporation | | Forzada / Forced / Ventilé | | | | | | |
| Potencia Power Puissance | (W) | - | - | - | - | - | - | - |
| Potencia frig. Cooling capacity Puissance Frig. | (W A -10°C) | - | - | - | - | - | - | - |
| Consumo Consumption Consommation | (kWh/ 24h) | 556 | 741 | 926 | 1112 | 1483 | 1853 | 2224 |
| Refrigerante Refrigerant Gaz | | R-290 | | | | | | |
| | | Puertas correderas traseras / Rear sliding doors / Portes coulissantes arrière | | | | | | |
| Opcional Optional Options | | (PUEV9CT) 58 € | (PUEV12CT) 70 € | (PUEV15CT) 87 € | (PUEV18CT) 99 € | (PUEV25CT) 124 € | (PUEV31CT) 158 € | (PUEV37CT) 174 € |
| | | Cortinas traseras nocturnas / Night curtains / Rideaux de nuit | | | | | | |
| | | (CCNV9) 140 € | (CCNV12) 149 € | (CCNV15) 180 € | (CCNV18) 233 € | (CCNV25) 299 € | (CCNV31) 359 € | (CCNV37) 467 € |
| | | Doble plano [sin reserva] / Double surface [without storage] / Double plan [sans réserve] | | | | | | |
| | (DPEXVMDBC9S) 69 € | (DPEXVMDBC12S) 92 € | (DPEXVMDBC15S) 116 € | (DPEXVMDBC18S) 139 € | (DPEXVMDBC25S) 185 € | (DPEXVMDBC31S) 231 € | (DPEXVMDBC37S) 277 € | |

Laterales no incluidos en el precio
Side panels not included in price
Joues non incluses dans le prix

Serie / Series / Série **MADRID**

+Info: www.infrico.com

VMD 18 SU



Laterales / Sides / Jous

| NO | |
|-----------------------------|----------------------------|
| Izquierdo Left Gauche | Derecho Right Droite |
| 266 € | 266 € |



VMD 25 RI



Detalle reserva
Storage detail
Détail réserve

Ext. Estándar / Standar / Standard

| | | |
|------------------------|----------------|----------------|
| Blanco/White/ Blanc | Ral 1001 | Ral 1018 |
| Ral 2003 | Ral 3003 | Ral 3020 |
| Design 2108025 | Ral 5015 | Ral 4007 |
| Ral 6002 | Design 1107060 | Design 3504035 |
| Ral 9006 | Ral 7016 | Ral 8017 |

Colores fuera de carta /
Colors outside of letter /
Couleurs spéciales, hors palette

| RAL | | NO RAL | |
|--|--------------------------------|---|--------------------------------|
| Epoxi | Líquida/ Liquid/ Liquide | Epoxi | Líquida/ Liquid/ Liquide |
| 817 € | 508 € | Consultar / Consulter / Consulter | |
| [x unidad/x unit/x unité] | | | |
| +10 días laborables / +10 work days / +10 jours ouvrés | | Consultar / Consulter / Consulter | |

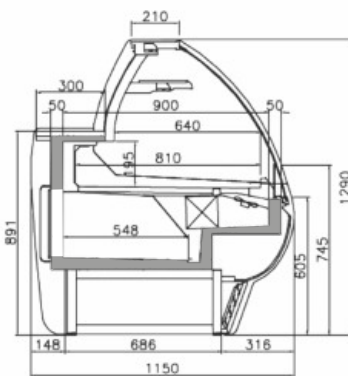



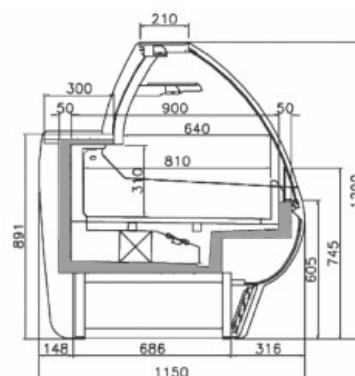







VMD R (con reserva)
[Whit storage]
[Avec réserve]



VMD S [Sin reserva]
[Whitout storage]
[Sans réserve]

Vitrina expositora modular frío ventilado grupo incorporado / Refrigerated modular plugin display case / Vitrine présentation froid ventilé canalisable groupe incorporé

Mueble caja / Counter case / Meuble de comptoir

| | | CON RESERVA / WHIT STORAGE / AVEC RÉSERVE RIU: Plano Inox / Stainless Steel exhibition plan / Plan d'exposition Inox | | | | MUEBLE CAJA / COUNTER CASE / MEUBLE DE COMPTOIR | | |
|---|-------------------|---|---|--|---|---|---|---|
| MODELO MODELE MODÈLE | |  |  |  |  |  |  |  |
| | | VMD 90 AA RU/RIU | VMD 45 AA RU/RIU | VMD 90 AC RU/RIU | VMD 45 AC RU/RIU | VMD 9 C | VMD 12 M | VMD 15 M |
| Precio Price Prix | RU | 11.039 € | 8.374 € | 7.791 € | 5.006 € | | | |
| | RIU | 11.502 € | 8.730 € | 8.124 € | 5.228 € | 1.702 € | 1.868 € | 2.043 € |
| | | SIN RESERVA / WHITOUT STORAGE / SANS RÉSERVE SIU: Plano Inox / Stainless Steel exhibition plan / Plan d'exposition Inox | | | | | | |
| MODELO MODELE MODÈLE | |  |  |  |  | - | - | - |
| | | VMD 90 AA SU/SIU | VMD 45 AA SU/SIU | VMD 90 AC SU/SIU | VMD 45 AC SU/SIU | - | - | - |
| Precio Price Prix | SU | 11.095 € | 8.398 € | 7.806 € | 4.779 € | - | - | - |
| | SIU | 11.561 € | 8.775 € | 8.140 € | 4.991 € | - | - | - |
| Medidas Measures Mesures | (mm) | 1326 x 1150 x 1290 mm. | 1108 x 1150 x 1290 mm. | 1887 x 1150 x 1290 mm. | 1470 x 1150 x 1290 mm. | 938 x 1150 x 906 mm. | 1250 x 1150 x 906 mm. | 1562 x 1150 x 906 mm. |
| Temperatura Temperature Température | (°C) | 0°C/+6°C | | | | - | | |
| Clase Climática Climatic class Classe climatique | (°C) | 4 / 30°C | | | | - | | |
| Tensión/Frecuencia Electrical data Tension électrique | | 230V/1ph/50Hz | | | | - | | |
| Controlador Controller Régulateur | | Digital | | | | - | | |
| Material Matériel | [EXT/INT] | Ext: acero plastificado / Plastified stainless steel / Acier plastifié Encimera / Worktop / Dessous: Inox Aisi 304 Plano exposición / Exhibition plan / Plan d'exposition: Acero plastif./ Plastif. Stainless steel/ Acier plastifié (Mod RU/SU) - Inox Aisi 304 (Mod. RIU/SIU) | | | | | | |
| Aislamiento Isolation Isolation | (mm) | 40kg/m ³ / Free CFC's / Zero ODP-GWP | | | | - | | |
| Capacidad Capacity Capacité | (L) | - | - | - | - | - | - | - |
| Superficie exposición Surface exhibition Surface d'exposition | (m ²) | 1,15 | 0,63 | 1,49 | 0,75 | 0,55 | 0,74 | 0,92 |
| Compresor Compressor Compresseur | (HP) | 5/8 | 3/8 | 3/4 | 1/2 | - | - | - |
| Estantes Shelving Étagères | | 1 | | | | - | | |
| Costados (2) Sides (2) Joues (2) | (mm) | | | | | 30+30 | | |
| Sistema de frío Cooling System Système de froid | | Ventilado / Ventilated / Ventilé | | | | - | | |
| Desescarche Defrost Dégivrage | | Automático / Automatic / Automatique | | | | - | | |
| Evaporación Evaporation Évaporation | | Forzada / Forced / Ventilé | | | | - | | |
| Potencia Power Puissance | (W) | 990 | 670 | 1060 | 740 | - | - | - |
| Potencia frig. Cooling capacity Puissance Frig. | (W A -10°C) | 1096 | 676 | 1315 | 817 | - | - | - |
| Consumo Consumption Consommation | (kWh/ 24h) | 13,9 | 9,4 | 14,8 | 10,4 | - | - | - |
| Refrigerante Refrigerant Gaz | | R-290 | | | | - | | |
| Opcional Optional Options | | Puertas corred. tras. / Rear sliding doors / Portes couliss. arrière [PUEV90AACT] 58 € | Puertas corred. tras. / Rear sliding doors / Portes couliss. arrière [PUEV45AACT] 38 € | Puertas corred. tras. / Rear sliding doors / Portes couliss. arrière [PUEV90ACCT] 156 € | Puertas corred. tras. / Rear sliding doors / Portes couliss. arrière [PUEV45ACCT] 86 € | - | | |

Laterales no incluidos en el precio
Side panels not included in price
Joues non incluses dans le prix

Serie / Series / Série **MADRID**

+Info: www.infrico.com

Lineal VMD
VMD Linear assembly
Assemblage lineaire VMD

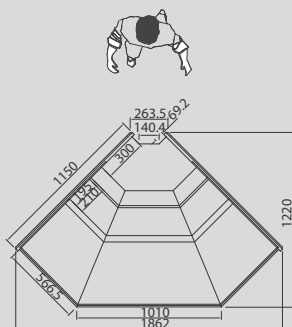
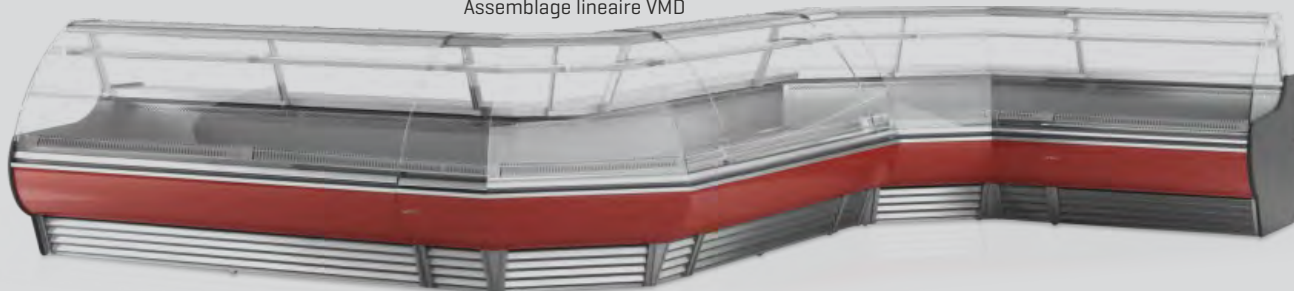

VMD 90 AA RU

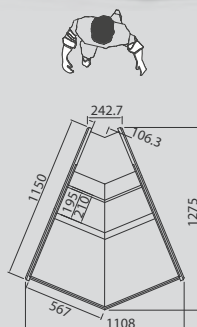

VMD 45 AA RU

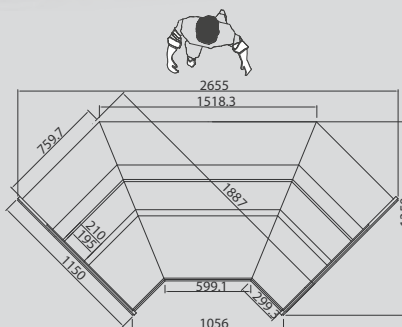

VMD 90 AC RU

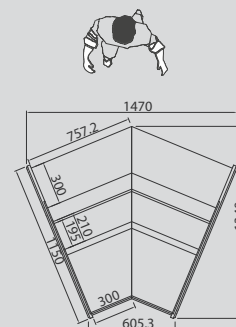

VMD 45 AC RU

Laterales / Sides / Jous

VMD C/M: SÍ

Laterales / Sides / Jous

VMD 90/45: NO

| | |
|-----------------------------|----------------------------|
| Izquierdo Left Gauche | Derecho Right Droite |
| 266 € | 266 € |

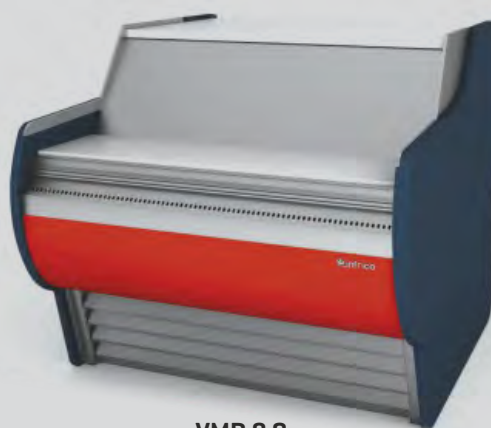

VMD 9 C

Ext. Estándar / Standar / Standard

| | | |
|------------------------|----------------|----------------|
| Blanco/White/ Blanc | Ral 1001 | Ral 1018 |
| Ral 2003 | Ral 3003 | Ral 3020 |
| Design 2108025 | Ral 5015 | Ral 4007 |
| Ral 6002 | Design 1107060 | Design 3504035 |
| Ral 9006 | Ral 7016 | Ral 8017 |

**Colores fuera de carta /
Colors outside of letter /
Couleurs spéciales, hors palette**

| RAL | | NO RAL | |
|--|--------------------------------|---|--------------------------------|
| Epoxi | Líquida/ Liquid/ Liquide | Epoxi | Líquida/ Liquid/ Liquide |
| 817 € | 508 € | Consultar / Consultar / Consulter | |
| [x unidad/x unit/x unité] | | | |
| +10 días laborables / +10 work days / +10 jours ouvrés | | Consultar / Consultar / Consulter | |





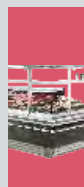







VMD 12 M



Vitrina expositora modular frío ventilado grupo remoto / Refrigerated modular display remote case / Vitrine présentation froid ventilé canalisable groupe à distance

Mueble caja / Counter case / Meuble de comptoir

| | | CON RESERVA / WHIT STORAGE / AVEC RÉSERVE RI: Plano Inox / Stainless Steel exhibition plan / Plan d'exposition Inox | | | | MUEBLE CAJA / COUNTER CASE / MEUBLE DE COMPTOIR | | |
|---|-------------------|--|---|--|---|---|---|---|
| MODELO MODELE MODÈLE | |  |  |  |  |  |  |  |
| | | VMD 90 AA R/RI | VMD 45 AA R/RI | VMD 90 AC R/RI | VMD 45 AC R/RI | VMD 9 C | VMD 12 M | VMD 15 M |
| Precio Price Prix | R | 10.779 € | 8.164 € | 7.532 € | 4.805 € | 1.702 € | 1.868 € | 2.043 € |
| | RI | 11.242 € | 8.520 € | 7.865 € | 5.026 € | | | |
| MODELO MODELE MODÈLE | | SIN RESERVA / WHITOUT STORAGE / SANS RÉSERVE SI: Plano Inox / Stainless Steel exhibition plan / Plan d'exposition Inox | | | | | | |
| | |  |  |  |  | - | - | - |
| | | VMD 90 AA S/SI | VMD 45 AA S/SI | VMD 90 AC S/SI | VMD 45 AC S/SI | - | - | - |
| Precio Price Prix | S | 10.836 € | 8.188 € | 7.546 € | 4.577 € | - | - | - |
| | SI | 11.301 € | 8.545 € | 7.880 € | 4.789 € | | | |
| Medidas Measures Mesures | (mm) | 1326 x 1150 x 1290 mm. | 1108 x 1150 x 1290 mm. | 1887 x 1150 x 1290 mm. | 1470 x 1150 x 1290 mm. | 938 x 1150 x 906 mm. | 1250 x 1150 x 906 mm. | 1562 x 1150 x 906 mm. |
| Temperatura Temperature Température | (°C) | 0°C/+6°C | | | | | | |
| Clase Climática Climatic class Classe climatique | (°C) | 4 / 30°C | | | | | | |
| Tensión/Frecuencia Electrical data Tension électrique | | 230V/1ph/50Hz | | | | | | |
| Controlador Controller Régulateur | | Digital | | | | | | |
| Material Matériel | (EXT/INT) | Ext: acero plastificado / Plastified stainless steel / Acier plastifié Encimera / Worktop / Dessous: Inox Aisi 304 Plano exposición / Exhibition plan / Plan d'exposition: Acero plastif./Plastif. Stainless steel/ Acier plastifié (Mod R/S) - Inox Aisi 304 (Mod. RI/SI) | | | | | | |
| Aislamiento Isolation Isolation | (mm) | 40kg/m ³ / Free CFC's / Zero ODP-GWP | | | | | | |
| Capacidad Capacity Capacité | (L) | - | - | - | - | - | - | - |
| Superficie exposición Surface exhibition Surface d'exposition | (m ²) | 1,15 | 0,63 | 1,49 | 0,75 | 0,55 | 0,74 | 0,92 |
| Compresor Compressor Compresseur | (HP) | - | - | - | - | - | - | - |
| Estantes Shelving Étagères | | 1 | | | | | | |
| Costados (2) Sides (2) Joues (2) | (mm) | 30+30 | | | | | | |
| Sistema de frío Cooling System Système de froid | | Ventilado / Ventilated / Ventilé | | | | | | |
| Desescarche Defrost Dégivrage | | Automático / Automatic / Automatique | | | | | | |
| Evaporación Evaporation Évaporation | | Forzada / Forced / Ventilé | | | | | | |
| Potencia Power Puissance | (W) | - | - | - | - | - | - | - |
| Potencia frig. Cooling capacity Puissance Frig. | (W A -10°C) | 780 | 391 | 1151 | 777 | - | - | - |
| Consumo Consumption Consommation | (kWh/ 24h) | - | - | - | - | - | - | - |
| Refrigerante Refrigerant Gaz | | R-290 | | | | | | |
| Opcional Optional Options | | Puertas corred. tras. / Rear sliding doors / Portes couliss. arrière [PUEV90AACT] 58 € | Puertas corred. tras. / Rear sliding doors / Portes couliss. arrière [PUEV45AACT] 38 € | Puertas corred. tras. / Rear sliding doors / Portes couliss. arrière [PUEV90ACCT] 156 € | Puertas corred. tras. / Rear sliding doors / Portes couliss. arrière [PUEV45ACCT] 86 € | | | |

Laterales no incluidos en el precio
Side panels not included in price
Joues non incluses dans le prix

Serie / Series / Série **MADRID**

+Info: www.infrico.com

Lineal VMD
VMD Linear assembly
Assemblage lineaire VMD

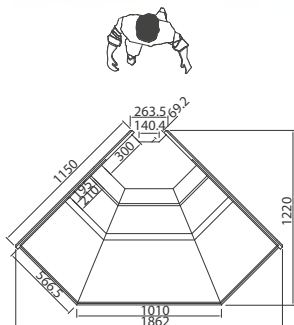
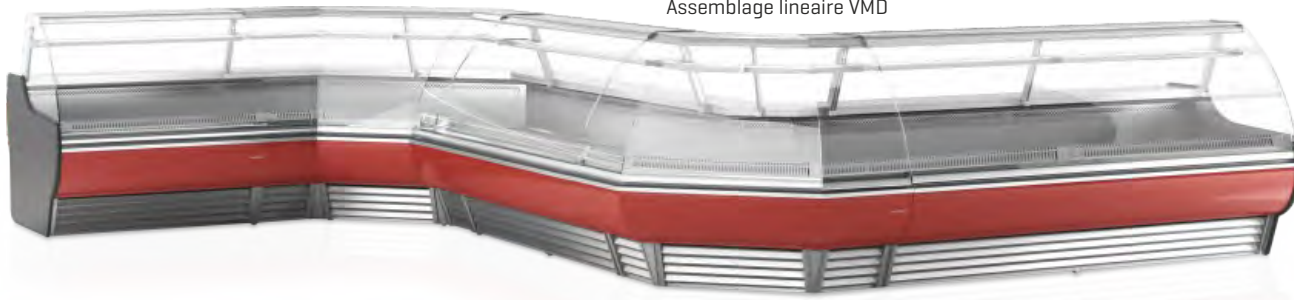

VMD 90 AA R

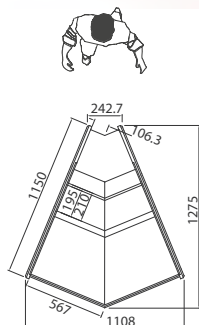

VMD 45 AA R

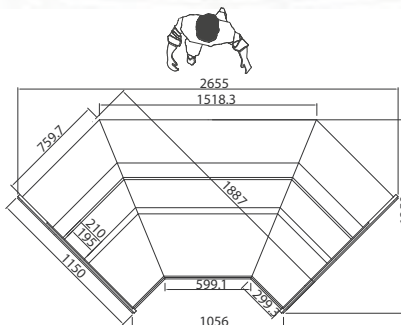

VMD 90 AC R

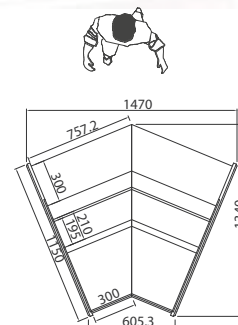

VMD 45 AC R

Laterales / Sides / Joues

VMD C/M: SÍ

Laterales / Sides / Joues

VMD 90/45: NO

| | |
|-----------------------------|----------------------------|
| Izquierdo Left Gauche | Derecho Right Droite |
| 266 € | 266 € |



VMD 12 M

Ext. Estándar / Standar / Standard

| | | |
|------------------------|----------------|----------------|
| Blanco/White/ Blanc | Ral 1001 | Ral 1018 |
| Ral 2003 | Ral 3003 | Ral 3020 |
| Design 2108025 | Ral 5015 | Ral 4007 |
| Ral 6002 | Design 1107060 | Design 3504035 |
| Ral 9006 | Ral 7016 | Ral 8017 |















**Colores fuera de carta /
Colors outside of letter /
Couleurs spéciales, hors palette**

| RAL | | NO RAL | |
|--|--------------------------------|---|--------------------------------|
| Epoxi | Líquida/ Liquid/ Liquide | Epoxi | Líquida/ Liquid/ Liquide |
| 817 € | 508 € | Consultar / Consulter / Consulter | |
| [x unidad/x unit/x unité] | | | |
| +10 días laborables / +10 work days / +10 jours ouvrés | | Consultar / Consulter / Consulter | |



VMD 9 C

Vitrina expositora modular frío ventilado grupo incorporado / Refrigerated modular plugin display case / Vitrine présentation froid ventilé canalisable groupe incorporé

| | | CON RESERVA / WHIT STORAGE / AVEC RÉSERVE - RIU: Plano Inox / Stainless Steel exhibition plan / Plan d'exposition Inox | | | | | | | | | | | | |
|---|--|--|---|---|---|---|---|---|--------------|---------------|--------------|---------------|--------------|---------------|
| | |  |  |  |  |  |  |  | | | | | | |
| MODELO MODELE MODÈLE | | VBC 9 RU/RIU | VBC 12 RU/RIU | VBC 15 RU/RIU | VBC 18 RU/RIU | VBC 25 RU/RIU | VBC 31 RU/RIU | VBC 37 RU/RIU | | | | | | |
| Precio Price Prix | RU | 3.482 € | 4.014 € | 4.401 € | 5.114 € | 6.328 € | 7.638 € | 8.470 € | | | | | | |
| | RIU | 3.608 € | 4.118 € | 4.598 € | 5.329 € | 6.584 € | 7.920 € | 8.805 € | | | | | | |
| | | SIN RESERVA / WHITOUT STORAGE / SANS RÉSERVE - SIU: Plano Inox / Stainless Steel exhibition plan / Plan d'exposition Inox | | | | | | | | | | | | |
| | |  |  |  |  |  |  |  | | | | | | |
| MODELO MODELE MODÈLE | | VBC 9 SU/SIU | VBC 12 SU/SIU | VBC 15 SU/SIU | VBC 18 SU/SIU | VBC 25 SU/SIU | VBC 31 SU/SIU | VBC 37 SU/SIU | | | | | | |
| Precio Price Prix | SU | 3.416 € | 3.909 € | 4.255 € | 4.883 € | 6.080 € | 7.396 € | 8.176 € | | | | | | |
| | SIU | 3.542 € | 4.044 € | 4.452 € | 5.098 € | 6.335 € | 7.719 € | 8.562 € | | | | | | |
| Medidas Measures Mesures | (mm) | 938 x 1150 x 1290 mm. | 1250 x 1150 x 1290 mm. | 1562 x 1150 x 1290 mm. | 1875 x 1150 x 1290 mm. | 2500 x 1150 x 1290 mm. | 3125 x 1150 x 1290 mm. | 3750 x 1150 x 1290 mm. | | | | | | |
| Temperatura Temperature Température | (°C) | 0°C/+6°C | | | | | | | | | | | | |
| Clase Climática Climatic class Classe climatique | (°C) | 4 / 30°C | | | | | | | | | | | | |
| Tensión/Frecuencia Electrical data Tension électrique | | 230V/1ph/50Hz | | | | | | | | | | | | |
| Controlador Controller Régulateur | | Digital | | | | | | | | | | | | |
| Material Matériel Matériel | [EXT/INT] | Ext: acero plastificado / Plastified stainless steel / Acier plastifié Encimera / Worktop / Dessous: Inox Aisi 304 Plano exposición / Exhibition plan / Plan d'exposition: Acero plastif. / Plastif. Stainless steel/ Acier plastifié [Mod RU/SU] - Inox Aisi 304 [Mod. RIU/SIU] | | | | | | | | | | | | |
| Aislamiento Isolation Isolation | (mm) | 40kg/m ³ / Free CFC's / Zero ODP-GWP | | | | | | | | | | | | |
| Capacidad Capacity Capacité | (L) | 82 | 109 | 137 | 164 | 219 | 273 | 328 | | | | | | |
| Superficie exposición Surface exhibition Surface d'exposition | (m ²) | 0,92 | 1,23 | 1,53 | 1,84 | 2,45 | 3,06 | 3,68 | | | | | | |
| Compresor Compressor Compresseur | (HP) | 1/3 | 1/2 | 3/4 | 3/4 | 1+1/4 | 1+1/4 | 1+1/4 | | | | | | |
| Estantes Shelving Étagères | | 1 | | | | | | | | | | | | |
| Costados (2) Sides (2) Joues (2) | (mm) | 30+30 | | | | | | | | | | | | |
| Sistema de frío Cooling System Système de froid | | Ventilado / Ventilated / Ventilé | | | | | | | | | | | | |
| Desescarche Defrost Dégivrage | | Automático / Automatic / Automatique | | | | | | | | | | | | |
| Evaporación Evaporation Évaporation | | Forzada / Forced / Ventilé | | | | | | | | | | | | |
| Potencia Power Puissance | (W) | 394 | 531 | 590 | 681 | 1115 | 2166 | 2190 | | | | | | |
| Potencia frig. Cooling capacity Puissance Frig. | (W A -10°C) | - | - | - | - | - | - | - | | | | | | |
| Consumo Consumption Consommation | (kWh/ 24h) | 5.18 | 7.01 | 7.8 | 8.9 | 14.6 | 28.6 | 28.9 | | | | | | |
| Refrigerante Refrigerant Gaz | | R-290 | | | | | | | | | | | | |
| Opcional Optional Options | Puertas correderas traseras / Rear sliding doors / Portes coulissantes arrière | | | | | | | | | | | | | |
| | (PUEV9CT) | 58 € | (PUEV12CT) | 70 € | (PUEV15CT) | 87 € | (PUEV18CT) | 99 € | (PUEV25CT) | 124 € | (PUEV31CT) | 158 € | (PUEV37CT) | 174 € |
| | Cortinas traseras nocturnas / Night curtains / Rideaux de nuit | | | | | | | | | | | | | |
| | (CCNV9) | 140 € | (CCNV12) | 149 € | (CCNV15) | 180 € | (CCNV18) | 233 € | (CCNV25) | 299 € | (CCNV31) | 359 € | (CCNV37) | 467 € |
| Opcional Optional Options | Cristal calefactado curvo / Heated curved frontal glass / Vitre bombé chauffée | | | | | | | | | | | | | |
| | (CRCCTVEU9) | 484 € | (CRCCTVEU12) | 517 € | (CRCCTVEU15) | 757 € | (CRCCTVEU18) | 793 € | (CRCCTVEU25) | 1032 € | (CRCCTVEU31) | 1379 € | (CRCCTVEU37) | 1447 € |

Laterales no incluidos en el precio
Side panels not included in price
Joues non incluses dans le prix

Serie / Series / Série **BARCELONA**

+Info: www.infrico.com

VBC 15 RU



Laterales / Sides / Joues

| NO | |
|-----------------------------|----------------------------|
| Izquierdo Left Gauche | Derecho Right Droite |
| 266 € | 266 € |

Ext. Estándar / Standar / Standard

| | | |
|------------------------|----------------|----------------|
| Blanco/White/ Blanc | Ral 1001 | Ral 1018 |
| Ral 2003 | Ral 3003 | Ral 3020 |
| Design 2108025 | Ral 5015 | Ral 4007 |
| Ral 6002 | Design 1107060 | Design 3504035 |
| Ral 9006 | Ral 7016 | Ral 8017 |

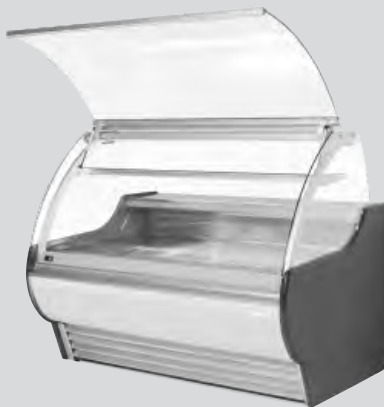

Colores fuera de carta /
Colors outside of letter /
Couleurs spéciales, hors palette

| RAL | | NO RAL | |
|--|--------------------------------|---|--------------------------------|
| Epoxi | Líquida/ Liquid/ Liquide | Epoxi | Líquida/ Liquid/ Liquide |
| 817 € | 508 € | Consultar / Consultar / Consulter | |
| [x unidad/x unit/x unité] | | | |
| +10 días laborables / +10 work days / +10 jours ouvrés | | Consultar / Consultar / Consulter | |

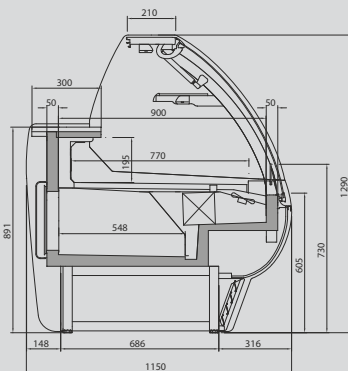

VBC RU/RIU (con reserva)
[Whit storage]
[Avec réserve]

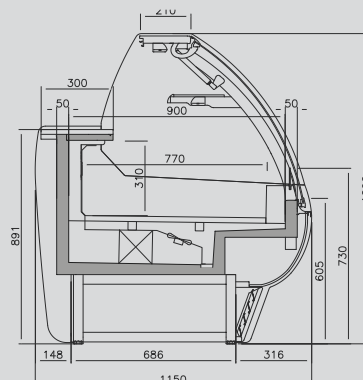













VBC SU/SIU (Sin reserva)
[Whitout storage]
[Sans réserve]



Vitrina expositora modular frío ventilado grupo incorporado / Refrigerated modular plugin display case / Vitrine présentation froid ventilé canalisable groupe incorporé

Mueble caja / Counter case / Meuble de comptoir

| | | CON RESERVA / WHIT STORAGE / AVEC RÉSERVE RIU: Plano Inox / Stainless Steel exhibition plan / Plan d'exposition Inox | | | | MUEBLE CAJA / COUNTER CASE / MEUBLE DE COMPTOIR | | | |
|---|-------------------|---|---|--|---|--|---|---|---|
| MODELO MODELE MODÈLE | |  |  |  |  |  |  |  |  |
| | | VBC 90 AA RU/RIU | VBC 45 AA RU/RIU | VBC 90 AC RU/RIU | VBC 45 AC RU/RIU | VBC 9 C | VBC 12 M | VBC 15 M | VBC 12 MHD |
| Precio Price Prix | RU | 8.136 € | 5.762 € | 9.804 € | 6.611 € | | | | |
| | RIU | 8.610 € | 6.106 € | 10.170 € | 6.843 € | 1.499 € | 1.614 € | 1.799 € | 1.701 € |
| | | SIN RESERVA / WHITOUT STORAGE / SANS RÉSERVE SIU: Plano Inox / Stainless Steel exhibition plan / Plan d'exposition Inox | | | | | | | |
| MODELO MODELE MODÈLE | |  |  |  |  | - | - | - | - |
| | | VBC 90 AA SU/SIU | VBC 45 AA SU/SIU | VBC 90 AC SU/SIU | VBC 45 AC SU/SIU | - | - | - | - |
| Precio Price Prix | SU | 8.374 € | 5.769 € | 10.165 € | 6.617 € | - | - | - | - |
| | SIU | 8.849 € | 6.113 € | 10.533 € | 6.840 € | - | - | - | - |
| Medidas Measures Mesures | (mm) | 1326 x 1150 x 1290 mm. | 1108 x 1150 x 1290 mm. | 1887 x 1150 x 1290 mm. | 1470 x 1150 x 1290 mm. | 938 x 1150 x 906 mm. | 1250 x 1150 x 906 mm. | 1562 x 1150 x 906 mm. | 1250 x 1150 x 906 mm. |
| Temperatura Temperature Température | (°C) | 0°C/+6°C | | | | | | | |
| Clase Climática Climatic class Classe climatique | (°C) | 4 / 30°C | | | | | | | |
| Tensión/Frecuencia Electrical data Tension électrique | | 230V/1ph/50Hz | | | | | | | |
| Controlador Controller Régulateur | | Digital | | | | | | | |
| Material Matériel Matériel | [EXT/INT] | Ext: acero plastificado / Plastified stainless steel / Acier plastifié Encimera / Worktop / Dessous: Inox Aisi 304 Plano exposición / Exhibition plan / Plan d'exposition: Acero plastif./ Plastif. Stainless steel/ Acier plastifié (Mod RU/SU) - Inox Aisi 304 (Mod. RIU/SIU) | | | | | | | |
| Aislamiento Isolation Isolation | (mm) | 40kg/m ³ / Free CFC's / Zero ODP-GWP | | | | | | | |
| Capacidad Capacity Capacité | (L) | - | - | - | - | - | - | - | - |
| Superficie exposición Surface exhibition Surface d'exposition | (m ²) | 1,09 | 0,60 | 1,43 | 0,72 | 0,55 | 0,74 | 0,92 | |
| Compresor Compressor Compresseur | (HP) | 5/8 | 3/8 | 3/4 | 1/2 | - | - | - | |
| Estantes Shelving Étagères | | 1 | | | | | | | |
| Costados (2) Sides (2) Joues (2) | (mm) | 30+30 | | | | | | | |
| Sistema de frío Cooling System Système de froid | | Ventilado / Ventilated / Ventilé | | | | | | | |
| Desescarche Defrost Dégivrage | | Automático / Automatic / Automatique | | | | | | | |
| Evaporación Evaporation Évaporation | | Forzada / Forced / Ventilé | | | | | | | |
| Potencia Power Puissance | (W) | 1025 | 700 | 1110 | 780 | - | - | - | - |
| Potencia frig. Cooling capacity Puissance Frig. | (W A -10°C) | - | - | - | - | - | - | - | - |
| Consumo Consumption Consommation | (kWh/ 24h) | 14,4 | 9,8 | 15,5 | 10,9 | - | - | - | - |
| Refrigerante Refrigerant Gaz | | R-290 | | | | | | | |
| Opcional Optional Options | | Puertas correderas tras. / Rear sliding doors / Portes couliss. arrière [PUEVBC90AACT] 55 € | Puertas correderas tras. / Rear sliding doors / Portes couliss. arrière [PUEVBC45AACT] 36 € | Puertas correderas tras. / Rear sliding doors / Portes couliss. arrière [PUEVBC90ACCT] 135 € | Puertas correderas tras. / Rear sliding doors / Portes couliss. arrière [PUEVBC45ACCT] 76 € | | | | |

Laterales no incluidos en el precio
Side panels not included in price
Joues non incluses dans le prix

Serie / Series / Série **BARCELONA**

+Info: www.infrico.com

Lineal VBC
VBC Linear assembly
Assemblage lineaire VBC

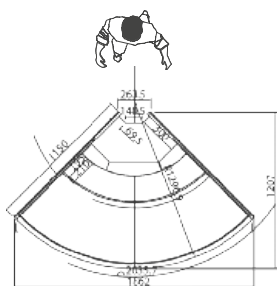

VBC 90 AA RU/RIU
VBC 90 AA SU/SIU

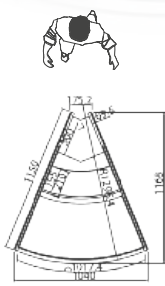

VBC 45 AA RU/RIU
VBC 45 AA SU/SIU

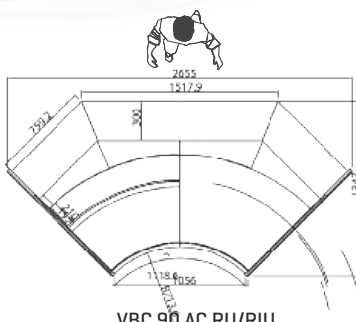

VBC 90 AC RU/RIU
VBC 90 AC SU/SIU

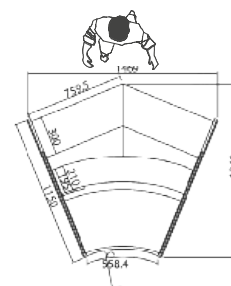

VBC 45 AC RU/RIU
VBC 45 AC SU/SIU

Laterales / Sides / Jous

VBC C/M/MHD: SÍ

Laterales / Sides / Jous

VBC 90/45: NO

| | |
|-----------------------------|----------------------------|
| Izquierdo Left Gauche | Derecho Right Droite |
| 266 € | 266 € |

Ext. Estándar / Standar / Standard

| | | |
|------------------------|----------------|----------------|
| Blanco/White/ Blanc | Ral 1001 | Ral 1018 |
| Ral 2003 | Ral 3003 | Ral 3020 |
| Design 2108025 | Ral 5015 | Ral 4007 |
| Ral 6002 | Design 1107060 | Design 3504035 |
| Ral 9006 | Ral 7016 | Ral 8017 |



VBC 12 M

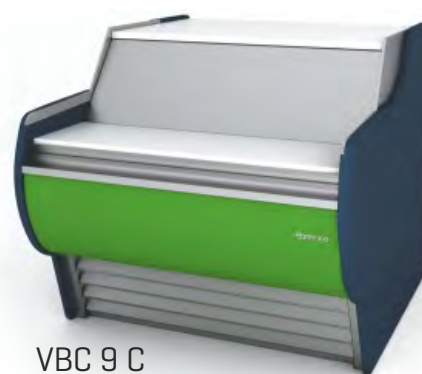

VBC 9 C

**Colores fuera de carta /
Colors outside of letter /
Couleurs spéciales, hors palette**

| RAL | | NO RAL | |
|--|--------------------------------|---|--------------------------------|
| Epoxi | Líquida/ Liquid/ Liquide | Epoxi | Líquida/ Liquid/ Liquide |
| 817 € | 508 € | Consultar / Consultar / Consulter | |
| [x unidad/x unit/x unité] | | | |
| +10 días laborables / +10 work days / +10 jours ouvrés | | Consultar / Consultar / Consulter | |

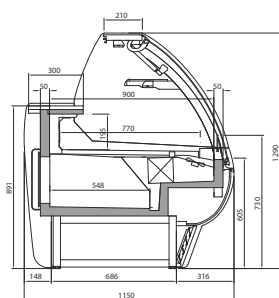

VBC RU [con reserva]
[Whit storage][Avec réserve]

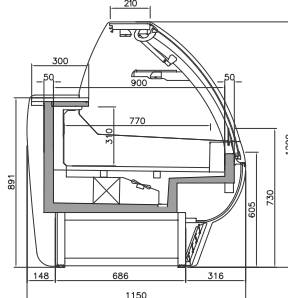



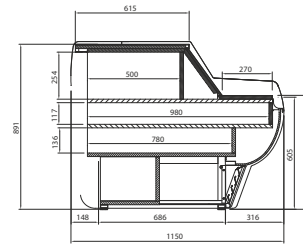











VBC SU [Sin reserva]
[Whitout storage][Sans réserve]



VBC

Vitrina expositora modular frío ventilado grupo remoto / Refrigerated modular display remote case / Vitrine présentation froid ventilé canalisable groupe à distance

| | | CON RESERVA / WHIT STORAGE / AVEC RÉSERVE - RI: Plano Inox / Stainless Steel exhibition plan / Plan d'exposition Inox | | | | | | |
|---|-------------------|--|---|---|---|---|---|---|
| | |  |  |  |  |  |  |  |
| MODELO MODELE MODÈLE | | VBC 9 R/RI | VBC 12 R/RI | VBC 15 R/RI | VBC 18 R/RI | VBC 25 R/RI | VBC 31 R/RI | VBC 37 R/RI |
| Precio Price Prix | R | 3.252 € | 3.728 € | 4.114 € | 4.789 € | 5.922 € | 6.824 € | 7.657 € |
| | RI | 3.378 € | 3.831 € | 4.311 € | 5.004 € | 6.177 € | 7.106 € | 7.992 € |
| | | SIN RESERVA / WHITOUT STORAGE / SANS RÉSERVE - SI: Plano Inox / Stainless Steel exhibition plan / Plan d'exposition Inox | | | | | | |
| | |  |  |  |  |  |  |  |
| MODELO MODELE MODÈLE | | VBC 9 S/SI | VBC 12 S/SI | VBC 15 S/SI | VBC 18 S/SI | VBC 25 S/SI | VBC 31 S/SI | VBC 37 S/SI |
| Precio Price Prix | S | 3.186 € | 3.623 € | 3.968 € | 4.558 € | 5.673 € | 6.582 € | 7.363 € |
| | SI | 3.312 € | 3.757 € | 4.165 € | 4.773 € | 5.928 € | 6.905 € | 7.748 € |
| Medidas Measures Mesures | (mm) | 938 x 1150 x 1290 mm. | 1250 x 1150 x 1290 mm. | 1562 x 1150 x 1290 mm. | 1875 x 1150 x 1290 mm. | 2500 x 1150 x 1290 mm. | 3125 x 1150 x 1290 mm. | 3750 x 1150 x 1290 mm. |
| Temperatura Temperature Température | (°C) | 0°C/+6°C | | | | | | |
| Clase Climática Climatic class Classe climatique | (°C) | 4 / 30°C | | | | | | |
| Tensión/Frecuencia Electrical data Tension électrique | | 230V/1ph/50Hz | | | | | | |
| Controlador Controller Régulateur | | Digital | | | | | | |
| Material Matériel | [EXT/INT] | Ext: acero plastificado / Plastified stainless steel / Acier plastifié Encimera / Worktop / Dessous: Inox Aisi 304 Plano exposición / Exhibition plan / Plan d'exposition: Acero plastif. / Plastif. Stainless steel/ Acier plastifié [Mod RU/SU] - Inox Aisi 304 [Mod. RIU/SIU] | | | | | | |
| Aislamiento Isolation Isolation | (mm) | 40kg/m ³ / Free CFC's / Zero ODP-GWP | | | | | | |
| Capacidad Capacity Capacité | (L) | 82 | 109 | 137 | 164 | 219 | 273 | 328 |
| Superficie exposición Surface exhibition Surface d'exposition | (m ²) | 0,92 | 1,23 | 1,53 | 1,84 | 2,45 | 3,06 | 3,68 |
| Compresor Compressor Compresseur | (HP) | - | - | - | - | - | - | - |
| Estantes Shelving Étagères | | 1 | | | | | | |
| Costados (2) Sides (2) Joues (2) | (mm) | 30+30 | | | | | | |
| Sistema de frío Cooling System Système de froid | | Ventilado / Ventilated / Ventilé | | | | | | |
| Desescarche Defrost Dégivrage | | Automático / Automatic / Automatique | | | | | | |
| Evaporación Evaporation Évaporation | | Forzada / Forced / Ventilé | | | | | | |
| Potencia Power Puissance | (W) | - | - | - | - | - | - | - |
| Potencia frig. Cooling capacity Puissance Frig. | (W A -10°C) | 623 | 830 | 1037 | 1245 | 1660 | 2075 | 2490 |
| Consumo Consumption Consommation | (kWh/ 24h) | - | - | - | - | - | - | - |
| Refrigerante Refrigerant Gaz | | R-290 | | | | | | |
| | | Puertas correderas traseras / Rear sliding doors / Portes coulissantes arrière | | | | | | |
| | | (PUEV9CT) 58 € | (PUEV12CT) 70 € | (PUEV15CT) 87 € | (PUEV18CT) 99 € | (PUEV25CT) 124 € | (PUEV31CT) 158 € | (PUEV37CT) 174 € |
| | | Cortinas traseras nocturnas / Night curtains / Rideaux de nuit | | | | | | |
| | | (CCNV9) 140 € | (CCNV12) 149 € | (CCNV15) 180 € | (CCNV18) 233 € | (CCNV25) 299 € | (CCNV31) 359 € | (CCNV37) 467 € |
| | | Cristal calefactado curvo / Heated curved frontal glass / Vitre bombé chauffée | | | | | | |
| | | (CRCCTVEU9) 484 € | (CRCCTVEU12) 517 € | (CRCCTVEU15) 757 € | (CRCCTVEU18) 793 € | (CRCCTVEU25) 1032 € | (CRCCTVEU31) 1379 € | (CRCCTVEU37) 1447 € |

Laterales no incluidos en el precio
Side panels not included in price
Joues non incluses dans le prix

Serie / Series / Série **BARCELONA**

+Info: www.infrico.com

VBC 15 RI



Laterales / Sides / Joues

| NO | |
|-----------------------------|----------------------------|
| Izquierdo Left Gauche | Derecho Right Droite |
| 266 € | 266 € |



Ext. Estándar / Standar / Standard

| | | |
|------------------------|----------------|----------------|
| Blanco/White/ Blanc | Ral 1001 | Ral 1018 |
| Ral 2003 | Ral 3003 | Ral 3020 |
| Design 2108025 | Ral 5015 | Ral 4007 |
| Ral 6002 | Design 1107060 | Design 3504035 |
| Ral 9006 | Ral 7016 | Ral 8017 |

**Colores fuera de carta /
Colors outside of letter /
Couleurs spéciales, hors palette**

| RAL | | NO RAL | |
|--|--------------------------------|---|--------------------------------|
| Epoxi | Líquida/ Liquid/ Liquide | Epoxi | Líquida/ Liquid/ Liquide |
| 817 € | 508 € | Consultar / Consultar / Consulter | |
| [x unidad/x unit/x unité] | | | |
| +10 días laborables / +10 work days / +10 jours ouvrés | | Consultar / Consultar / Consulter | |

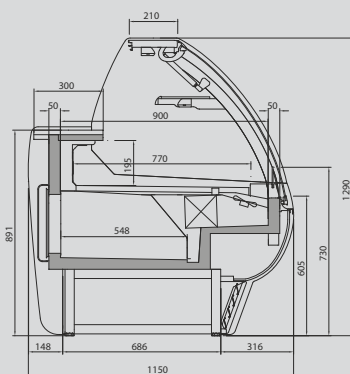

**VBC R/RI [con reserva]
[Whit storage]
[Avec réserve]**

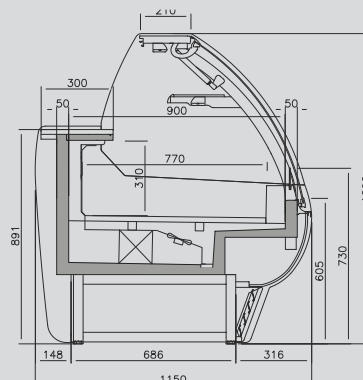



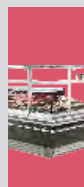









**VBC S/SI [Sin reserva]
[Whitout storage]
[Sans réserve]**



Vitrina expositora modular frío ventilado grupo remoto / Refrigerated modular display remote case / Vitrine présentation froid ventilé canalisable groupe à distance

Mueble caja / Counter case / Meuble de comptoir

| | | CON RESERVA / WHIT STORAGE / AVEC RÉSERVE RI: Plano Inox / Stainless Steel exhibition plan / Plan d'exposition Inox | | | | MUEBLE CAJA / COUNTER CASE / MEUBLE DE COMPTOIR | | | |
|---|-------------------|---|---|--|---|--|---|---|---|
| MODELO MODELE MODÈLE | |  |  |  |  |  |  |  |  |
| | | VBC 90 AA R/RI | VBC 45 AA R/RI | VBC 90 AC R/RI | VBC 45 AC R/RI | VBC 9 C | VBC 12 M | VBC 15 M | VBC 12 MHD |
| Precio Price Prix | R | 7.849 € | 5.532 € | 9.516 € | 6.374 € | | | | |
| | RI | 8.322 € | 5.876 € | 9.883 € | 6.606 € | 1.499 € | 1.614 € | 1.799 € | 1.701 € |
| | | SIN RESERVA / WHITOUT STORAGE / SANS RÉSERVE SIU: Plano Inox / Stainless Steel exhibition plan / Plan d'exposition Inox | | | | | | | |
| MODELO MODELE MODÈLE | |  |  |  |  | - | - | - | - |
| | | VBC 90 AA S/SI | VBC 45 AA S/SI | VBC 90 AC S/SI | VBC 45 AC S/SI | - | - | - | - |
| Precio Price Prix | S | 8.086 € | 5.539 € | 9.877 € | 6.380 € | - | - | - | - |
| | SI | 8.562 € | 5.883 € | 10.245 € | 6.602 € | - | - | - | - |
| Medidas Measures Mesures | [mm] | 1326 x 1150 x 1290 mm. | 1108 x 1150 x 1290 mm. | 1887 x 1150 x 1290 mm. | 1470 x 1150 x 1290 mm. | 938 x 1150 x 906 mm. | 1250 x 1150 x 906 mm. | 1562 x 1150 x 906 mm. | 1250 x 1150 x 906 mm. |
| Temperatura Temperature Température | [°C] | 0°C/+6°C | | | | - | | | |
| Clase Climática Climatic class Classe climatique | [°C] | 4 / 30°C | | | | - | | | |
| Tensión/Frecuencia Electrical data Tension électrique | | 230V/1ph/50Hz | | | | - | | | |
| Controlador Controller Régulateur | | Digital | | | | - | | | |
| Material Matériel [EXT/INT] | | Ext: acero plastificado / Plastified stainless steel / Acier plastifié Encimera / Worktop / Dessous: Inox Aisi 304 Plano exposición / Exhibition plan / Plan d'exposition: Acero plastif./ Plastif. Stainless steel/ Acier plastifié [Mod RU/SU] - Inox Aisi 304 [Mod. RIU/SIU] | | | | | | | |
| Aislamiento Isolation Isolation | [mm] | 40kg/m ³ / Free CFC's / Zero ODP-GWP | | | | - | | | |
| Capacidad Capacity Capacité | [L] | - | - | - | - | - | - | - | - |
| Superficie exposición Surface exhibition Surface d'exposition | [m ²] | 1,09 | 0,60 | 1,43 | 0,72 | 0,55 | 0,74 | 0,92 | |
| Compresor Compressor Compresseur | [HP] | - | - | - | - | - | - | - | - |
| Estantes Shelving Étagères | | 1 | | | | - | | | |
| Costados (2) Sides (2) Joues (2) | [mm] | 30+30 | | | | | | | |
| Sistema de frío Cooling System Système de froid | | Ventilado / Ventilated / Ventilé | | | | - | | | |
| Desescarche Defrost Dégivrage | | Automático / Automatic / Automatique | | | | - | | | |
| Evaporación Evaporation Évaporation | | Forzada / Forced / Ventilé | | | | - | | | |
| Potencia Power Puissance | [W] | - | - | - | - | - | - | - | - |
| Potencia frig. Cooling capacity Puissance Frig. | [W A -10°C] | 304 | 403 | 11598 | 801 | - | - | - | - |
| Consumo Consumption Consommation | [kWh/ 24h] | - | - | - | - | - | - | - | - |
| Refrigerante Refrigerant Gaz | | R-290 | | | | - | | | |
| Opcional Optional Options | | Puertas correderas tras. / Rear sliding doors / Portes couliss. arrière [PUEVBC90AACT] 55 € | Puertas correderas tras. / Rear sliding doors / Portes couliss. arrière [PUEVBC45AACT] 36 € | Puertas correderas tras. / Rear sliding doors / Portes couliss. arrière [PUEVBC90ACCT] 135 € | Puertas correderas tras. / Rear sliding doors / Portes couliss. arrière [PUEVBC45ACCT] 76 € | - | | | |

Laterales no incluidos en el precio
Side panels not included in price
Joues non incluses dans le prix

Serie / Series / Série **BARCELONA**

+Info: www.infrico.com

Lineal VBC
VBC Linear assembly
Assemblage lineaire VBC

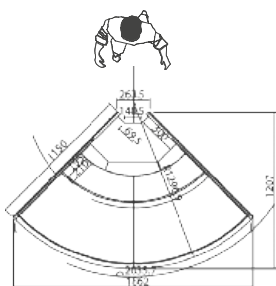

VBC 90 AA R/RI
VBC 90 AA S/SI

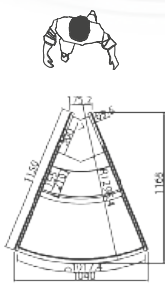

VBC 45 AA R/RI
VBC 45 AA S/SI

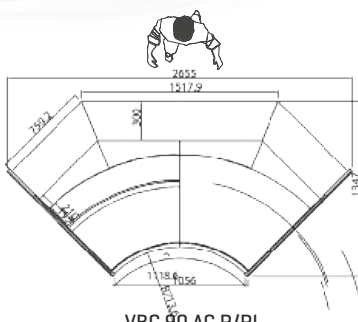

VBC 90 AC R/RI
VBC 90 AC S/SI

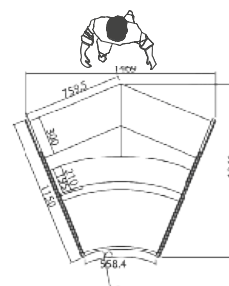

VBC 45 AC R/RI
VBC 45 AC S/SI

Laterales / Sides / Joutes

VBC C/M/MHD: SÍ

Laterales / Sides / Joutes

VBC 90/45: NO

| | |
|-----------------------------|----------------------------|
| Izquierdo Left Gauche | Derecho Right Droite |
| 266 € | 266 € |

Ext. Estándar / Standar / Standard

| | | |
|------------------------|----------------|----------------|
| Blanco/White/ Blanc | Ral 1001 | Ral 1018 |
| Ral 2003 | Ral 3003 | Ral 3020 |
| Design 2108025 | Ral 5015 | Ral 4007 |
| Ral 6002 | Design 1107060 | Design 3504035 |
| Ral 9006 | Ral 7016 | Ral 8017 |



VBC 12 M

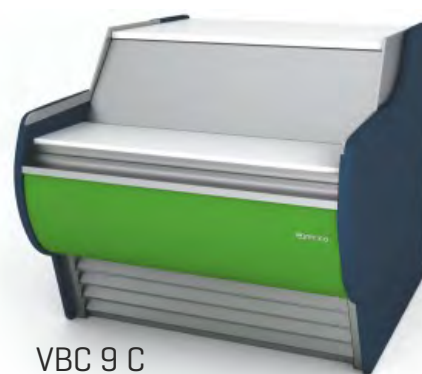

VBC 9 C

**Colores fuera de carta /
Colors outside of letter /
Couleurs spéciales, hors palette**

| RAL | | NO RAL | |
|--|--------------------------------|---|--------------------------------|
| Epoxi | Líquida/ Liquid/ Liquide | Epoxi | Líquida/ Liquid/ Liquide |
| 817 € | 508 € | Consultar / Consultar / Consulter | |
| [x unidad/x unit/x unité] | | | |
| +10 días laborables / +10 work days / +10 jours ouvrés | | Consultar / Consultar / Consulter | |

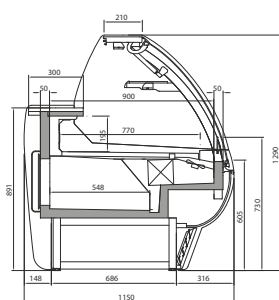

VBC R/RI [con reserva]
[Whit storage][Avec réserve]

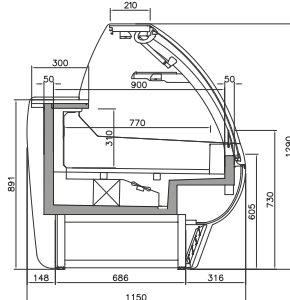



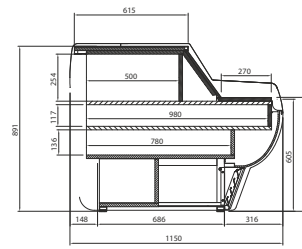











VBC S/SI [Sin reserva]
[Whitout storage][Sans réserve]



VBC

Vitrina expositora modular frío ventilado grupo incorporado / Refrigerated modular plugin display case / Vitrine présentation froid ventilé canalisable groupe incorporé

| | | CON RESERVA / WHIT STORAGE / AVEC RÉSERVE - RIU: Plano Inox / Stainless Steel exhibition plan / Plan d'exposition Inox | | | | | | | | | | | | |
|--|--|--|---|---|---|---|---|---|------------|--------------|------------|--------------|------------|--------------|
| | |  |  |  |  |  |  |  | | | | | | |
| | | VBC 9 RUCP/RIUCP | VBC 12 RUCP/RIUCP | VBC 15 RUCP/RIUCP | VBC 18 RUCP/RIUCP | VBC 25 RUCP/RIUCP | VBC 31 RUCP/RIUCP | VBC 37 RUCP/RIUCP | | | | | | |
| Precio Price | RUCP | 3.597 € | 4.040 € | 4.536 € | 5.322 € | 6.749 € | 7.873 € | 8.637 € | | | | | | |
| Prix | RIUCP | 3.723 € | 4.177 € | 4.733 € | 5.538 € | 7.005 € | 8.155 € | 8.972 € | | | | | | |
| | | SIN RESERVA / WHITOUT STORAGE / SANS RÉSERVE - SIU: Plano Inox / Stainless Steel exhibition plan / Plan d'exposition Inox | | | | | | | | | | | | |
| | |  |  |  |  |  |  |  | | | | | | |
| | | VBC 9 SUCP/SIUCP | VBC 12 SUCP/SIUCP | VBC 15 SUCP/SIUCP | VBC 18 SUCP/SIUCP | VBC 25 SUCP/SIUCP | VBC 31 SUCP/SIUCP | VBC 37 SUCP/SIUCP | | | | | | |
| Precio Price | SUCP | 3.479 € | 3.926 € | 4.413 € | 5.034 € | 6.377 € | 7.631 € | 8.338 € | | | | | | |
| Prix | SIUCP | 3.605 € | 4.062 € | 4.611 € | 5.249 € | 6.632 € | 7.954 € | 8.723 € | | | | | | |
| Medidas Measures | [mm] | 938 x 1150 x 1290 mm. | 1250 x 1150 x 1290 mm. | 1562 x 1150 x 1290 mm. | 1875 x 1150 x 1290 mm. | 2500 x 1150 x 1290 mm. | 3125 x 1150 x 1290 mm. | 3750 x 1150 x 1290 mm. | | | | | | |
| Temperatura Temperature | [°C] | 0°C/+6°C | | | | | | | | | | | | |
| Clase Climática Climatic class | [°C] | 4 / 30°C | | | | | | | | | | | | |
| Tensión/Frecuencia Electrical data | | 230V/1ph/50Hz | | | | | | | | | | | | |
| Controlador Controller | | Digital | | | | | | | | | | | | |
| Material Material | [EXT/INT] | Ext: acero plastificado / Plastified stainless steel / Acier plastifié Encimera / Worktop / Dessous: Inox Aisi 304 Plano exposición / Exhibition plan / Plan d'exposition: Acero plastif. / Plastif. Stainless steel/ Acier plastifié [Mod RU/SU] - Inox Aisi 304 [Mod. RIU/SIU] | | | | | | | | | | | | |
| Aislamiento Isolation | [mm] | 40kg/m ³ / Free CFC's / Zero ODP-GWP | | | | | | | | | | | | |
| Capacidad Capacity | [L] | 82 | 109 | 137 | 164 | 219 | 273 | 328 | | | | | | |
| Superficie exposición Surface exhibition | [m ²] | 0,92 | 1,23 | 1,53 | 1,84 | 2,45 | 3,06 | 3,68 | | | | | | |
| Compresor Compressor | [HP] | 1/3 | 1/2 | 3/4 | 3/4 | 1+1/4 | 1+1/4 | 1+1/4 | | | | | | |
| Estantes Shelving | | 1 | | | | | | | | | | | | |
| Costados (2) Sides (2) | [mm] | 30+30 | | | | | | | | | | | | |
| Sistema de frío Cooling System | | Ventilado / Ventilated / Ventilé | | | | | | | | | | | | |
| Desescarche Defrost | | Automático / Automatic / Automatique | | | | | | | | | | | | |
| Evaporación Evaporation | | Forzada / Forced / Ventilé | | | | | | | | | | | | |
| Potencia Power | [W] | 374 | 532 | 601 | 702 | 1177 | 1210 | 1234 | | | | | | |
| Potencia frig. Cooling capacity | [W A -10°C] | - | - | - | - | - | - | - | | | | | | |
| Consumo Consumption | [kWh/24h] | 4.7 | 6.4 | 7.2 | 8.4 | 12.7 | 14.5 | 16.3 | | | | | | |
| Refrigerante Refrigerant | | R-290 | | | | | | | | | | | | |
| Opcional Options | Puertas correderas traseras / Rear sliding doors / Portes coulissantes arrière | | | | | | | | | | | | | |
| | [PUEV9CT] | 58 € | [PUEV12CT] | 70 € | [PUEV15CT] | 87 € | [PUEV18CT] | 99 € | [PUEV25CT] | 124 € | [PUEV31CT] | 158 € | [PUEV37CT] | 174 € |
| | Cortinas traseras nocturnas / Night curtains / Rideaux de nuit | | | | | | | | | | | | | |
| | [CCNV9] | 140 € | [CCNV12] | 149 € | [CCNV15] | 180 € | [CCNV18] | 233 € | [CCNV25] | 299 € | [CCNV31] | 359 € | [CCNV37] | 467 € |

Laterales no incluidos en el precio
Side panels not included in price
Joues non incluses dans le prix

VBC 12 RUCP



VBC 12 SUCP



Laterales / Sides / Joues

| NO | |
|-----------------------------|----------------------------|
| Izquierdo Left Gauche | Derecho Right Droite |
| 376 € | 376 € |

Ext. Estándar / Standar / Standard

| | | |
|------------------------|----------------|----------------|
| Blanco/White/ Blanc | Ral 1001 | Ral 1018 |
| Ral 2003 | Ral 3003 | Ral 3020 |
| Design 2108025 | Ral 5015 | Ral 4007 |
| Ral 6002 | Design 1107060 | Design 3504035 |
| Ral 9006 | Ral 7016 | Ral 8017 |

**Colores fuera de carta /
Colors outside of letter /
Couleurs spéciales, hors palette**

| RAL | | NO RAL | |
|--|--------------------------------|---|--------------------------------|
| Epoxi | Líquida/ Liquid/ Liquide | Epoxi | Líquida/ Liquid/ Liquide |
| 817 € | 508 € | Consultar / Consulter / Consulter | |
| [x unidad/x unit/x unité] | | | |
| +10 días laborables / +10 work days / +10 jours ouvrés | | Consultar / Consulter / Consulter | |

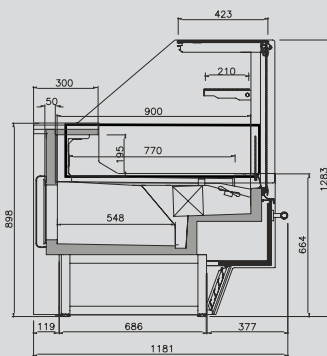



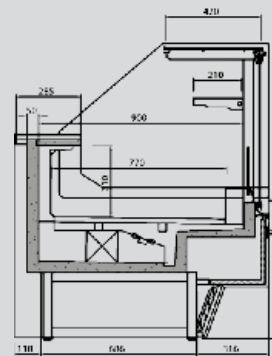





**VBC RU (con reserva)
[Whit storage]
[Avec réserve]**



**VBC SU (Sin reserva)
[Whitout storage]
[Sans réserve]**

Vitrina expositora modular frío ventilado grupo incorporado / Refrigerated modular plugin display case / Vitrine présentation froid ventilé canalisable groupe incorporé

Mueble caja / Counter case / Meuble de comptoir

| | | CON RESERVA / WHIT STORAGE / AVEC RÉSERVE RIU: Plano Inox / Stainless Steel exhibition plan / Plan d'exposition Inox | | MUEBLE CAJA / COUNTER CASE / MEUBLE DE COMPTOIR | | | |
|---|-------------------|--|--|---|--|---|---|
| | |  |  |  |  |  |  |
| MODELO MODELE MODÈLE | | VBC90 A RUCP/RIUCP | VBC90 C RUCP/RIUCP | VBC 9 CP | VBC 12 MP | VBC 15 MP | VBC 12 MHDP |
| Precio Price Prix | RUCP | 7.701 € | 9.410 € | 1.604 € | 2.139 € | 1.799 € | 2.016 € |
| | RIUCP | 8.174 € | 9.753 € | | | | |
| MODELO MODELE MODÈLE | | SIN RESERVA / WHITOUT STORAGE / SANS RÉSERVE SIU: Plano Inox / Stainless Steel exhibition plan / Plan d'exposition Inox | | | | | |
| | |  |  | - | - | - | - |
| | | VBC90 A SUCP/SIUCP | VBC90 C SUCP/SIUCP | | | | |
| Precio Price Prix | SUCP | 7.581 € | 9.180 € | - | - | - | - |
| | SIUCP | 8.055 € | 9.524 € | | | | |
| Medidas Measures Mesures | (mm) | 1887 x 1150 x 1290 mm. | 1470 x 1150 x 1290 mm. | 938 x 1150 x 906 mm. | 1250 x 1150 x 906 mm. | 1562 x 1150 x 906 mm. | 1250 x 1150 x 906 mm. |
| Temperatura Temperature Température | (°C) | 0°C/+6°C | | | | | |
| Clase Climática Climatic class Classe climatique | (°C) | 4 / 30°C | | | | | |
| Tensión/Frecuencia Electrical data Tension électrique | | 230V/1ph/50Hz | | | | | |
| Controlador Controller Régulateur | | Digital | | | | | |
| Material Matériel | [EXT/INT] | Ext: acero plastificado / Plastified stainless steel / Acier plastifié Encimera / Worktop / Dessous: Inox Aisi 304 Plano exposición / Exhibition plan / Plan d'exposition: Acero plastif. / Plastif. Stainless steel/ Acier plastifié [Mod RU/SU] - Inox Aisi 304 [Mod. RIU/SIU] | | | | | |
| Aislamiento Isolation Isolation | (mm) | 40kg/m ³ / Free CFC's / Zero ODP-GWP | | | | | |
| Capacidad Capacity Capacité | (L) | 1,09 | 1,43 | - | - | - | - |
| Superficie exposición Surface exhibition Surface d'exposition | (m ²) | - | - | 0,55 | 0,74 | 0,92 | - |
| Compresor Compressor Compresseur | (HP) | 5/8 | 3/4 | - | - | - | - |
| Estantes Shelving Étagères | | - | | | | | |
| Costados (2) Sides (2) Joues (2) | (mm) | 30+30 | | | | | |
| Sistema de frío Cooling System Système de froid | | Ventilado / Ventilated / Ventilé | | | | | |
| Desescarche Defrost Dégivrage | | Automático / Automatic / Automatique | | | | | |
| Evaporación Evaporation Évaporation | | Forzada / Forced / Ventilé | | | | | |
| Potencia Power Puissance | (W) | 1025 | 1110 | - | - | - | - |
| Potencia frig. Cooling capacity Puissance Frig. | (W A -10°C) | - | - | - | - | - | - |
| Consumo Consumption Consommation | (kWh/ 24h) | 14,4 | 15,5 | - | - | - | - |
| Refrigerante Refrigerant Gaz | | R-290 | | | | | |
| Opcional Optional Options | | Puertas correderas tras. / Rear sliding doors / Portes couliss. arrière (PUEVBC90ARCT) 126 € | Puertas correderas tras. / Rear sliding doors / Portes couliss. arrière (PUEVBC90CRCT) 139 € | | | | |

**Laterales no incluidos en el precio
Side panels not included in price
Joues non incluses dans le prix**

Serie / Series / Série **BARCELONA**

+Info: www.infrico.com



Lineal VBC
VBC Linear assembly
Assemblage lineaire VBC



Laterales / Sides / Jous

VBC CP/MP/MHDP: SÍ

Laterales / Sides / Jous

VBC 90: NO

| | |
|-----------------------------|----------------------------|
| Izquierdo Left Gauche | Derecho Right Droite |
| 376 € | 376 € |

Ext. Estándar / Standar / Standard

| | | |
|------------------------|----------------|----------------|
| Blanco/White/ Blanc | Ral 1001 | Ral 1018 |
| Ral 2003 | Ral 3003 | Ral 3020 |
| Design 2108025 | Ral 5015 | Ral 4007 |
| Ral 6002 | Design 1107060 | Design 3504035 |
| Ral 9006 | Ral 7016 | Ral 8017 |

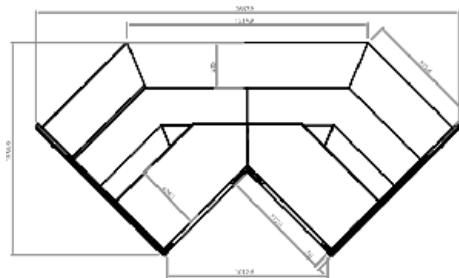

VBC 90 AC RUCP/SUCP

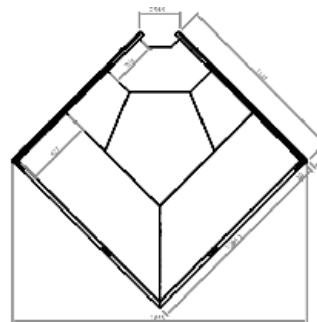

VBC 90 AA RUCP/SUCP

Colores fuera de carta / Colors outside of letter / Couleurs spéciales, hors palette

| RAL | | NO RAL | |
|--|--------------------------------|---|--------------------------------|
| Epoxi | Líquida/ Liquid/ Liquide | Epoxi | Líquida/ Liquid/ Liquide |
| 817 € | 508 € | Consultar / Consultar / Consulter | |
| [x unidad/x unit/x unité] | | | |
| +10 días laborables / +10 work days / +10 jours ouvrés | | Consultar / Consultar / Consulter | |

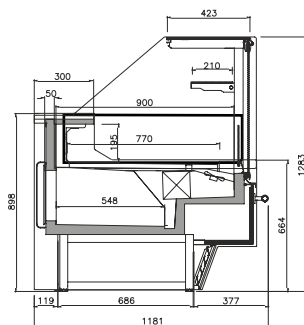

VBC RUCP (con reserva)
[Whit storage]
[Avec réserve]

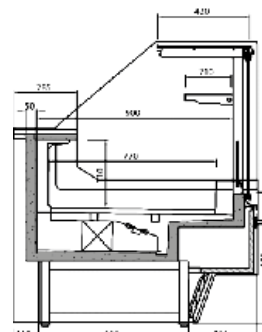



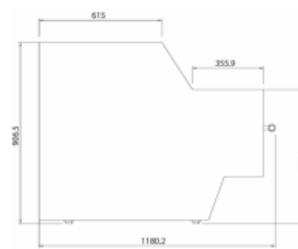











VBC SUCP (Sin reserva)
[Whitout storage]
[Sans réserve]



VBC P

Vitrina expositora modular frío ventilado grupo remoto / Refrigerated modular display remote case / Vitrine présentation froid ventilé canalisable groupe à distance

| | | CON RESERVA / WHIT STORAGE / AVEC RÉSERVE - RI: Plano Inox / Stainless Steel exhibition plan / Plan d'exposition Inox | | | | | | |
|---|--|---|---|---|---|---|---|---|
| | |  |  |  |  |  |  |  |
| MODELO MODELE MODÈLE | | VBC 9 RCP/RICP | VBC 12 RCP/RICP | VBC 15 RCP/RICP | VBC 18 RCP/RICP | VBC 25 RCP/RICP | VBC 31 RCP/RICP | VBC 37 RCP/RICP |
| Precio Price Prix | RCP | 3.367 € | 3.754 € | 4.249 € | 4.998 € | 6.343 € | 7.059 € | 7.824 € |
| | RICP | 3.493 € | 3.890 € | 4.447 € | 5.213 € | 6.598 € | 7.342 € | 8.159 € |
| | | SIN RESERVA / WHITOUT STORAGE / SANS RÉSERVE - SIU: Plano Inox / Stainless Steel exhibition plan / Plan d'exposition Inox | | | | | | |
| | |  |  |  |  |  |  |  |
| MODELO MODELE MODÈLE | | VBC 9 SCP/SICP | VBC 12 SCP/SICP | VBC 15 SCP/SICP | VBC 18 SCP/SICP | VBC 25 SCP/SICP | VBC 31 SCP/SICP | VBC 37 SCP/SICP |
| Precio Price Prix | SCP | 3.249 € | 3.639 € | 4.127 € | 4.709 € | 5.970 € | 6.818 € | 7.524 € |
| | SICP | 3.375 € | 3.776 € | 4.324 € | 4.925 € | 6.225 € | 7.140 € | 7.910 € |
| Medidas Mesures Mesures | [mm] | 938 x 1150 x 1290 mm. | 1250 x 1150 x 1290 mm. | 1562 x 1150 x 1290 mm. | 1875 x 1150 x 1290 mm. | 2500 x 1150 x 1290 mm. | 3125 x 1150 x 1290 mm. | 3750 x 1150 x 1290 mm. |
| Temperatura Temperature Température | [°C] | 0°C/+6°C | | | | | | |
| Clase Climática Climatic class Classe climatique | [°C] | 4 / 30°C | | | | | | |
| Tensión/Frecuencia Electrical data Tension électrique | | 230V/1ph/50Hz | | | | | | |
| Controlador Controller Régulateur | | Digital | | | | | | |
| Material Matériel Matériel | [EXT/INT] | Ext: acero plastificado / Plastified stainless steel / Acier plastifié Encimera / Worktop / Dessous: Inox Aisi 304 Plano exposición / Exhibition plan / Plan d'exposition: Acero plastif./Plastif. Stainless steel/ Acier plastifié (Mod R/S) - Inox Aisi 304 (Mod. S/SI) | | | | | | |
| Aislamiento Isolation Isolation | [mm] | 40kg/m ³ / Free CFC's / Zero ODP-GWP | | | | | | |
| Capacidad Capacity Capacité | [L] | 82 | 109 | 137 | 164 | 219 | 273 | 328 |
| Superficie exposición Surface exhibition Surface d'exposition | [m ²] | 0,92 | 1,23 | 1,53 | 1,84 | 2,45 | 3,06 | 3,68 |
| Compresor Compressor Compresseur | [HP] | - | - | - | - | - | - | - |
| Estantes Shelving Étagères | | 1 | | | | | | |
| Costados (2) Sides (2) Joues (2) | [mm] | 30+30 | | | | | | |
| Sistema de frío Cooling System Système de froid | | Ventilado / Ventilated / Ventilé | | | | | | |
| Desescarche Defrost Dégivrage | | Automático / Automatic / Automatique | | | | | | |
| Evaporación Evaporation Évaporation | | Forzada / Forced / Ventilé | | | | | | |
| Potencia Power Puissance | [W] | - | - | - | - | - | - | - |
| Potencia frig. Cooling capacity Puissance Frig. | [W A -10°C] | 656 | 874 | 1092 | 1315 | 1748 | 2184 | 2621 |
| Consumo Consumption Consommation | [kWh/ 24h] | - | - | - | - | - | - | - |
| Refrigerante Refrigerant Gaz | | R-290 | | | | | | |
| Opcional Optional Options | Puertas correderas traseras / Rear sliding doors / Portes coulissantes arrière | | | | | | | |
| | | [PUEV9CT] 58 € | [PUEV12CT] 70 € | [PUEV15CT] 87 € | [PUEV18CT] 99 € | [PUEV25CT] 124 € | [PUEV31CT] 158 € | [PUEV37CT] 174 € |
| | Cortinas traseras nocturnas / Night curtains / Rideaux de nuit | | | | | | | |
| | | [CCNV9] 140 € | [CCNV12] 149 € | [CCNV15] 180 € | [CCNV18] 233 € | [CCNV25] 299 € | [CCNV31] 359 € | [CCNV37] 467 € |

Laterales no incluidos en el precio
Side panels not included in price
Joues non incluses dans le prix

Serie / Series / Série **BARCELONA**

+Info: www.infrico.com

VBC 12 SCP



Laterales / Sides / Joues

| NO | |
|-----------------------------|----------------------------|
| Izquierdo Left Gauche | Derecho Right Droite |
| 376 € | 376 € |

Ext. Estándar / Standar / Standard

| | | |
|------------------------|----------------|----------------|
| Blanco/White/ Blanc | Ral 1001 | Ral 1018 |
| Ral 2003 | Ral 3003 | Ral 3020 |
| Design 2108025 | Ral 5015 | Ral 4007 |
| Ral 6002 | Design 1107060 | Design 3504035 |
| Ral 9006 | Ral 7016 | Ral 8017 |

VBC 12 RCP



Colores fuera de carta /
Colors outside of letter /
Couleurs spéciales, hors palette

| RAL | | NO RAL | |
|--|--------------------------------|---|--------------------------------|
| Epoxi | Líquida/ Liquid/ Liquide | Epoxi | Líquida/ Liquid/ Liquide |
| 817 € | 508 € | Consultar / Consultar / Consulter | |
| [x unidad/x unit/x unité] | | | |
| +10 días laborables / +10 work days / +10 jours ouvrés | | Consultar / Consultar / Consulter | |

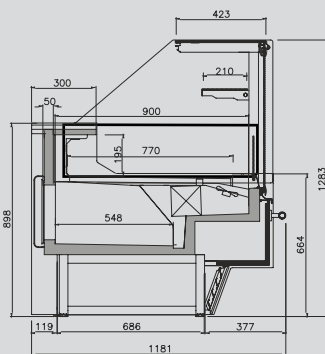

VBC R [con reserva]
[Whit storage]
[Avec réserve]

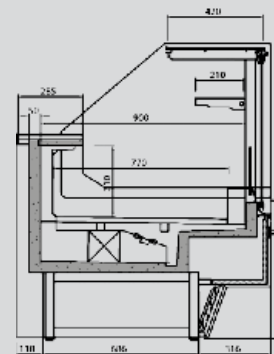



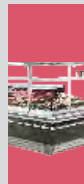





VBC S [Sin reserva]
[Whitout storage]
[Sans réserve]



Vitrina expositora modular frío ventilado grupo remoto / Refrigerated modular display remote case / Vitrine présentation froid ventilé canalisable groupe à distance

Mueble caja / Counter case / Meuble de comptoir

| | | CON RESERVA / WHIT STORAGE / AVEC RÉSERVE Rt: Plano Inox / Stainless Steel exhibition plan / Plan d'exposition Inox | | MUEBLE CAJA / COUNTER CASE / MEUBLE DE COMPTOIR | | | |
|---|-------------------|---|---|--|--|---|---|
| MODELO MODELE MODÈLE | |  |  |  |  |  |  |
| Precio Price Prix | RCP IRCP | 7.413 € | 9.122 € | 1.604 € | 2.139 € | 1.799 € | 2.016 € |
| | | 7.518 € | 9.236 € | | | | |
| MODELO MODELE MODÈLE | | SIN RESERVA / WHITOUT STORAGE / SANS RÉSERVE St: Plano Inox / Stainless Steel exhibition plan / Plan d'exposition Inox | | | | | |
| | |  |  | - | - | - | - |
| Precio Price Prix | SCP ISCP | 7.293 € | 8.379 € | - | - | - | - |
| | | 7.508 € | 8.461 € | | | | |
| Medidas Measures Mesures | (mm) | 1887 x 1150 x 1290 mm. | 1470 x 1150 x 1290 mm. | 938 x 1150 x 906 mm. | 1250 x 1150 x 906 mm. | 1562 x 1150 x 906 mm. | 1250 x 1150 x 906 mm. |
| Temperatura Temperature Température | (°C) | 0°C/+6°C | | | | | |
| Clase Climática Climatic class Classe climatique | (°C) | 4 / 30°C | | | | | |
| Tensión/Frecuencia Electrical data Tension électrique | | 230V/1ph/50Hz | | | | | |
| Controlador Controller Régulateur | | Digital | | | | | |
| Material Materiel Matériel | [EXT/INT] | Ext: acero plastificado / Plastified stainless steel / Acier plastifié Encimera / Worktop / Dessous: Inox Aisi 304 Plano exposición / Exhibition plan / Plan d'exposition: Acero plastif./ Plastif. Stainless steel/ Acier plastifié [Mod RCP/SCP] - Inox Aisi 304 [Mod. I] | | | | | |
| Aislamiento Isolation Isolation | (mm) | 40kg/m ³ / Free CFC's / Zero ODP-GWP | | | | | |
| Capacidad Capacity Capacité | (L) | 1,09 | 1,43 | - | - | - | - |
| Superficie exposición Surface exhibition Surface d'exposition | (m ²) | - | - | 0,55 | 0,74 | 0,92 | - |
| Compresor Compressor Compresseur | (HP) | - | - | - | - | - | - |
| Estantes Shelving Étagères | | - | | | | | |
| Costados (2) Sides (2) Joues (2) | (mm) | 30+30 | | | | | |
| Sistema de frío Cooling System Système de froid | | Ventilado / Ventilated / Ventilé | | | | | |
| Desescarche Defrost Dégivrage | | Automático / Automatic / Automatique | | | | | |
| Evaporación Evaporation Évaporation | | Forzada / Forced / Ventilé | | | | | |
| Potencia Power Puissance | (W) | - | - | - | - | - | - |
| Potencia frig. Cooling capacity Puissance Frig. | (W A -10°C) | 1096 | 1315 | - | - | - | - |
| Consumo Consumption Consommation | (kWh/ 24h) | - | - | - | - | - | - |
| Refrigerante Refrigerant Gaz | | R-290 | | | | | |
| Opcional Optional Options | | Puertas correderas tras. / Rear sliding doors / Portes couliss. arrière (PUEVBC90ARCT) 126 € | | Puertas correderas tras. / Rear sliding doors / Portes couliss. arrière (PUEVBC90CRCT) 139 € | | - | |

**Laterales no incluidos en el precio
Side panels not included in price
Joues non incluses dans le prix**

Serie / Series / Série **BARCELONA**

+Info: www.infrico.com

Lineal VBC
VBC Linear assembly
Assemblage lineaire VBC



Laterales / Sides / Joues

VBC CP/MP/MHDP: SÍ

Laterales / Sides / Joues

VBC90 AA-AC: NO

| | |
|-----------------------------|----------------------------|
| Izquierdo Left Gauche | Derecho Right Droite |
|-----------------------------|----------------------------|

| | |
|--------------|--------------|
| 376 € | 376 € |
|--------------|--------------|

Ext. Estándar / Standar / Standard

| | | |
|------------------------|----------------|----------------|
| Blanco/White/ Blanc | Ral 1001 | Ral 1018 |
| Ral 2003 | Ral 3003 | Ral 3020 |
| Design 2108025 | Ral 5015 | Ral 4007 |
| Ral 6002 | Design 1107060 | Design 3504035 |
| Ral 9006 | Ral 7016 | Ral 8017 |

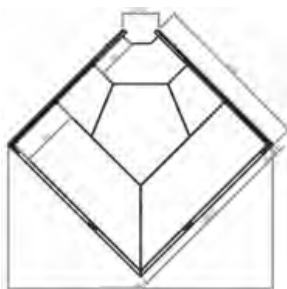

VBC 90 AA RCP/SCP

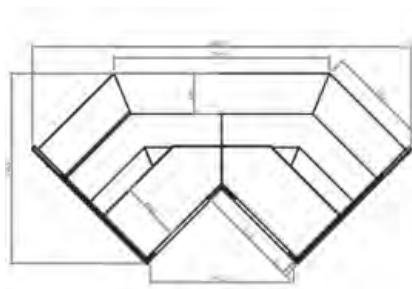

VBC 90 AC RCP/SCP

**Colores fuera de carta /
Colors outside of letter /
Couleurs spéciales, hors palette**

| RAL | | NO RAL | |
|--|--------------------------------|---|--------------------------------|
| Epoxi | Líquida/ Liquid/ Liquide | Epoxi | Líquida/ Liquid/ Liquide |
| 817 € | 508 € | Consultar / Consulter / Consulter | |
| [x unidad/x unit/x unité] | | | |
| +10 días laborables / +10 work days / +10 jours ouvrés | | Consultar / Consulter / Consulter | |

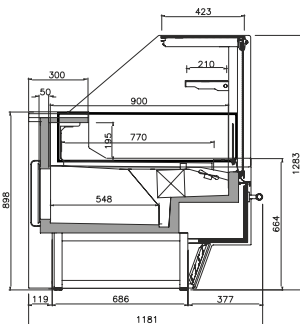

VBC RCP [con reserva]
[Whit storage]
[Avec réserve]

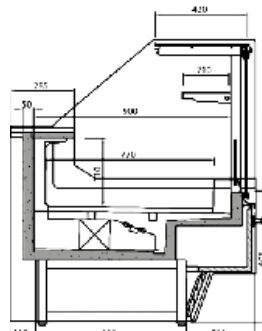



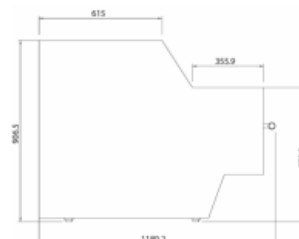







VBC SCP [Sin reserva]
[Whitout storage]
[Sans réserve]



VBC P

Vitrina expositora modular frío ventilado grupo incorporado / Refrigerated modular plugin display case / Vitrine présentation froid ventilé canalisable groupe incorporé

| | | CURVA / CURVED / BOMBÉE - SIU: Plano Inox / Stainless Steel exhibition plan / Plan d'exposition Inox | | | | |
|---|-------------------|---|---|---|---|---|
| MODELO MODELE MODÈLE | |  VBC 9 SUCB/SIUCB |  VBC 12 SUCB/SIUCB |  VBC 15 SUCB/SIUCB |  VBC 18 SUCB/SIUCB |  VBC 25 SUCB/SIUCB |
| Precio Price Prix | SUCB | 3.230 € | 3.567 € | 4.144 € | 4.559 € | 5.178 € |
| | SIUCB | 3.356 € | 3.693 € | 4.342 € | 4.774 € | 5.451 € |
| MODELO MODELE MODÈLE | | RECTA / FLAT / DROITE - SIU: Plano Inox / Stainless Steel exhibition plan / Plan d'exposition Inox | | | | |
| | |  VBC 9 SUCB CP/SIUCB CP |  VBC 12 SUCB CP/SIUCB CP |  VBC 15 SUCB CP/SIUCB CP |  VBC 18 SUCB CP/SIUCB CP |  VBC 25 SUCB CP/SIUCB CP |
| Precio Price Prix | SUCB CP | 3.465 € | 3.867 € | 4.377 € | 4.792 € | 5.398 € |
| | SIUCB CP | 3.591 € | 4.004 € | 4.575 € | 5.007 € | 5.671 € |
| Medidas Measures Mesures | (mm) | 938 x 1181 x 897 mm. | 1250 x 1181 x 897 mm. | 1562 x 1181 x 897 mm. | 1875 x 1181 x 897 mm. | 2500 x 1181 x 897 mm. |
| Temperatura Temperature Température | (°C) | 0°C/+6°C | | | | |
| Clase Climática Climatic class Classe climatique | (°C) | 4 / 30°C | | | | |
| Tensión/Frecuencia Electrical data Tension électrique | | 230V/1ph/50Hz | | | | |
| Controlador Controller Régulateur | | Digital | | | | |
| Material Matériel | [EXT/INT] | Ext: acero plastificado / Plastified stainless steel / Acier plastifié Encimera / Worktop / Dessous: Inox Aisi 304 Plano exposición / Exhibition plan / Plan d'exposition: Acero plastif./ Plastif. Stainless steel/ Acier plastifié [Mod SUCB/SUCP] - Inox Aisi 304 [Mod. I] | | | | |
| Aislamiento Isolation Isolation | (mm) | 40kg/m ³ / Free CFC's / Zero ODP-GWP | | | | |
| Capacidad Capacity Capacité | (L) | 108 | 144 | 180 | 217 | 289 |
| Superficie exposición Surface exhibition Surface d'exposition | (m ²) | 0,72 | 0,96 | 1,20 | 1,44 | 1,93 |
| Compresor Compressor Compresseur | (HP) | 1/3 | 1/2 | 3/4 | 3/4 | 1+1/4 |
| Estantes Shelving Étagères | | - | | | | |
| Costados (2) Sides (2) Joues (2) | (mm) | 30+30 | | | | |
| Sistema de frío Cooling System Système de froid | | Ventilado / Ventilated / Ventilé | | | | |
| Desescarche Defrost Dégivrage | | Automático / Automatic / Automatique | | | | |
| Evaporación Evaporation Évaporation | | Forzada / Forced / Ventilé | | | | |
| Potencia Power Puissance | (W) | 593 | 701 | 816 | 823 | 1207 |
| Potencia frig. Cooling capacity Puissance Frig. | (W A -10°C) | - | - | - | - | - |
| Consumo Consumption Consommation | (kWh/ 24h) | 7,10 | 8,04 | 9,80 | 10,1 | 14,5 |
| Refrigerante Refrigerant Gaz | | R-290 | | | | |
| Opcional Optional Options | | - | | | | |

Laterales no incluidos en el precio
Side panels not included in price
Joues non incluses dans le prix

VBC 15 SUCB



Laterales / Sides / Joues **SUCB**

| NO | |
|-----------------------------|----------------------------|
| Izquierdo Left Gauche | Derecho Right Droite |
| 332 € | 332 € |

Ext. Estándar / Standar / Standard

| | | |
|------------------------|----------------|----------------|
| Blanco/White/ Blanc | Ral 1001 | Ral 1018 |
| Ral 2003 | Ral 3003 | Ral 3020 |
| Design 2108025 | Ral 5015 | Ral 4007 |
| Ral 6002 | Design 1107060 | Design 3504035 |
| Ral 9006 | Ral 7016 | Ral 8017 |



Cortina nocturna de serie
Standard night curtain
Rideau de nuit de série

Colores fuera de carta /
Colors outside of letter /
Couleurs spéciales, hors palette

| RAL | | NO RAL | |
|--|--------------------------------|---|--------------------------------|
| Epoxi | Líquida/ Liquid/ Liquide | Epoxi | Líquida/ Liquid/ Liquide |
| 817 € | 508 € | Consultar / Consultar / Consulter | |
| [x unidad/x unit/x unité] | | | |
| +10 días laborables / +10 work days / +10 jours ouvrés | | Consultar / Consultar / Consulter | |

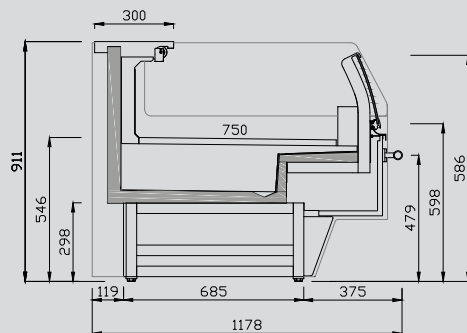



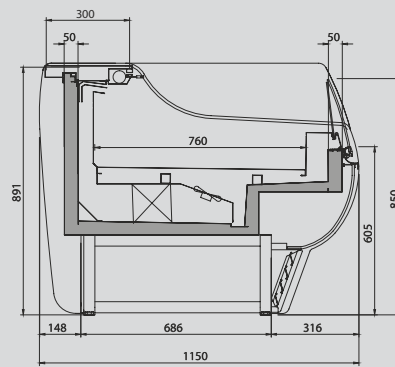





VBC SUCB CP

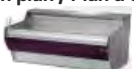

VBC SUCB

Vitrina expositora modular frío ventilado grupo remoto / Refrigerated modular display remote case / Vitrine présentation froid ventilé canalisable groupe à distance

| | | CURVA / CURVED / BOMBÉE - SI: Plano Inox / Stainless Steel exhibition plan / Plan d'exposition Inox | | | | |
|---|-------------------|---|---|---|---|---|
| MODELO MODELE MODÈLE | |  VBC 9 SCB/SICB |  VBC 12 SCB/SICB |  VBC 15 SCB/SICB |  VBC 18 SCB/SICB |  VBC 25 SCB/SICB |
| Precio Price Prix | SCB | 3.000 € | 3.280 € | 3.858 € | 4.235 € | 4.771 € |
| | SICB | 3.126 € | 3.406 € | 4.055 € | 4.450 € | 5.044 € |
| | | RECTA / FLAT / DROITE - SI: Plano Inox / Stainless Steel exhibition plan / Plan d'exposition Inox | | | | |
| MODELO MODELE MODÈLE | |  VBC 9 SCB CP/SICB CP |  VBC 12 SCB CP/SICB CP |  VBC 15 SCB CP/SICB CP |  VBC 18 SCB CP/SICB CP |  VBC 25 SCB CP/SICB CP |
| Precio Price Prix | SCB CP | 3.235 € | 3.581 € | 4.091 € | 4.468 € | 4.992 € |
| | SICB CP | 3.361 € | 3.717 € | 4.288 € | 4.683 € | 5.265 € |
| Medidas Measures Mesures | (mm) | 938 x 1181 x 897 mm. | 1250 x 1181 x 897 mm. | 1562 x 1181 x 897 mm. | 1875 x 1181 x 897 mm. | 2500 x 1181 x 897 mm. |
| Temperatura Temperature Température | (°C) | 0°C/+6°C | | | | |
| Clase Climática Climatic class Classe climatique | (°C) | 4 / 30°C | | | | |
| Tensión/Frecuencia Electrical data Tension électrique | | 230V/1ph/50Hz | | | | |
| Controlador Controller Régulateur | | Digital | | | | |
| Material Matériel | [EXT/INT] | Ext: acero plastificado / Plastified stainless steel / Acier plastifié Encimera / Worktop / Dessous: Inox Aisi 304 Plano exposición / Exhibition plan / Plan d'exposition: Acero plastif./ Plastif. Stainless steel/ Acier plastifié [Mod SCB/SCP] - Inox Aisi 304 [Mod. I] | | | | |
| Aislamiento Isolation Isolation | (mm) | 40kg/m ³ / Free CFC's / Zero ODP-GWP | | | | |
| Capacidad Capacity Capacité | (L) | 108 | 144 | 180 | 217 | 289 |
| Superficie exposición Surface exhibition Surface d'exposition | (m ²) | 0,72 | 0,96 | 1,20 | 1,44 | 1,93 |
| Compresor Compressor Compresseur | (HP) | - | - | - | - | - |
| Estantes Shelving Étagères | | - | | | | |
| Costados (2) Sides (2) Joues (2) | (mm) | 30+30 | | | | |
| Sistema de frío Cooling System Système de froid | | Ventilado / Ventilated / Ventilé | | | | |
| Desescarche Defrost Dégivrage | | Automático / Automatic / Automatique | | | | |
| Evaporación Evaporation Évaporation | | Forzada / Forced / Ventilé | | | | |
| Potencia Power Puissance | (W) | - | - | - | - | - |
| Potencia frig. Cooling capacity Puissance Frig. | (W A -10°C) | 817 | 1096 | 1315 | 1506 | 2009 |
| Consumo Consumption Consommation | (kWh/ 24h) | - | - | - | - | - |
| Refrigerante Refrigerant Gaz | | R-290 | | | | |
| Opcional Optional Options | | - | | | | |

Laterales no incluidos en el precio
Side panels not included in price
Joues non incluses dans le prix

VBC 15 SCB CP



Laterales / Sides / Jous **SCB CP**

| NO | |
|-----------------------------|----------------------------|
| Izquierdo Left Gauche | Derecho Right Droite |
| 264 € | 264 € |

Ext. Estándar / Standar / Standard

| | | |
|------------------------|----------------|----------------|
| Blanco/White/ Blanc | Ral 1001 | Ral 1018 |
| Ral 2003 | Ral 3003 | Ral 3020 |
| Design 2108025 | Ral 5015 | Ral 4007 |
| Ral 6002 | Design 1107060 | Design 3504035 |
| Ral 9006 | Ral 7016 | Ral 8017 |



Cortina nocturna de serie
Standard night curtain
Rideau de nuit de série

Colores fuera de carta /
Colors outside of letter /
Couleurs spéciales, hors palette

| RAL | | NO RAL | |
|--|--------------------------------|---|--------------------------------|
| Epoxi | Líquida/ Liquid/ Liquide | Epoxi | Líquida/ Liquid/ Liquide |
| 817 € | 508 € | Consultar / Consultar / Consulter | |
| [x unidad/x unit/x unité] | | | |
| +10 días laborables / +10 work days / +10 jours ouvrés | | Consultar / Consultar / Consulter | |

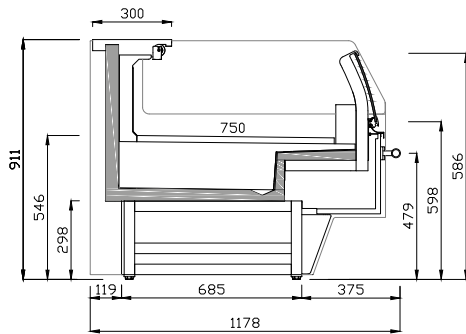

VBC SCB CP

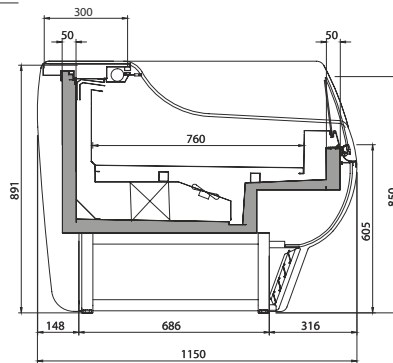

VBC SCB





9















+Info: www.infrico.com

osmarc.es



Los datos técnicos están sujetos a posibles variaciones que serán actualizadas periódicamente en las fichas técnicas del producto, disponibles en la web /
The technical data are subject to possible variations that will be updated periodically in the technical data sheets of the product, which are available on the website /
Les données techniques peuvent varier et seront actualisées dans les fiches techniques du produit, disponibles sur le site web.

Vitrina Experience grupo incorporado / Plug in refrigerated display case Experience / Vitrine Experience groupe incorporé

| CRISTAL RECTO / FLAT GLASS / VITRE DROITE | | | | | | | | | | | | | | |
|--|---|---|---|---|---|---|---|-------|-------|-------|-------|-------|-------|-------|
| MODELO MODELE MODÈLE |  |  |  |  |  |  |  | | | | | | | |
| Precio Price Prix | 3.891 € | 4.172 € | 4.556 € | 4.949 € | 6.067 € | 7.416 € | 7.968 € | | | | | | | |
| MOD. | VEX09 IU CP | VEX12 IU CP | VEX15 IU CP | VEX18 IU CP | VEX25 IU CP | VEX31 IU CP | VEX37 IU CP | | | | | | | |
| Precio PLANO INOX Price STAINL. STEEL SURF. Prix PLAN INOX | 3.948 € | 4.270 € | 4.707 € | 5.085 € | 6.286 € | 7.869 € | 8.504 € | | | | | | | |
| CRISTAL CURVO / CURVED GLASS / VITRE BOMBÉE | | | | | | | | | | | | | | |
| MODELO MODELE MODÈLE |  |  |  |  |  |  |  | | | | | | | |
| Precio Price Prix | 3.720 € | 4.223 € | 4.472 € | 4.762 € | 6.135 € | 7.447 € | 8.186 € | | | | | | | |
| MOD. | VEX09 IU | VEX12 IU | VEX15 IU | VEX18 IU | VEX25 IU | VEX31 IU | VEX37 IU | | | | | | | |
| Precio PLANO INOX Price STAINL. STEEL SURF. Prix PLAN INOX | 3.777 € | 4.319 € | 4.601 € | 4.967 € | 6.340 € | 7.639 € | 8.463 € | | | | | | | |
| Medidas Mesures [mm] | 938 x 1295 x 1220 mm. | 1250 x 1295 x 1220 mm. | 1562 x 1295 x 1220 mm. | 1875 x 1295 x 1220 mm. | 2500 x 1295 x 1220 mm. | 3125 x 1295 x 1220 mm. | 3750 x 1295 x 1220 mm. | | | | | | | |
| Temperatura Temperature Température [°C] | -1°C/+5°C | | | | | | | | | | | | | |
| Clase Climática Climatic class Classe climatique [°C] | 4 / 30°C | | | | | | | | | | | | | |
| Tensión/Frecuencia Electrical data Tension électrique | 230V/1ph/50Hz | | | | | | | | | | | | | |
| Controlador Controller Régulateur | Digital | | | | | | | | | | | | | |
| Material Matériel [EXT/INT] | Ext + Costados/Sides/Joues: acero plastificado / Plastified steel / Acier plastifié Encimera / Worktop / Dessous: Inox Aisi 304 Plano exposición / Exhibition plan / Plan d'exposition: Acero plastif./Plastif. steel/ Acier plastifié [Mod U/UCP] - Inox Aisi 304 [Mod. I] | | | | | | | | | | | | | |
| Aislamiento Isolation [mm] | 40kg/m³ / Free CFC's / Zero ODP-GWP | | | | | | | | | | | | | |
| Capacidad Capacity Capacité [L] | 169 | 225 | 281 | 338 | 450 | 563 | 675 | | | | | | | |
| Superficie exposición Surface exhibition Surface d'exposition [m²] | 0,84 | 1,13 | 1,41 | 1,69 | 2,25 | 2,81 | 3,40 | | | | | | | |
| Compresor Compressor Compresseur [HP] | 1/3 | 1/2 | 3/4 | 3/4 | 1 1/4 | 1 1/4 | 1 1/4 | | | | | | | |
| Costados [2] Sides [2] Joues [2] [mm] | 30 + 30 | | | | | | | | | | | | | |
| Sistema de frío Cooling System Système de froid | Ventilado / Ventilated / Ventilé | | | | | | | | | | | | | |
| Desescarche Defrost Dégivrage | Automático / Automatic / Automatique | | | | | | | | | | | | | |
| Evaporación Evaporation Evaporation | Forzada / Forced / Ventilé | | | | | | | | | | | | | |
| Potencia Power Puissance [W] | 484 | 650 | 714 | 810 | 1264 | 2461 | 2493 | | | | | | | |
| Potencia frig. Cooling capacity Puissance Frig. [W A -10°C] | - | | | | | | | | | | | | | |
| Consumo Consumption Consommation [kWh/ 24h] | 6,9 | 9,4 | 10,3 | 11,7 | 18,2 | 35,4 | 35,9 | | | | | | | |
| Refrigerante Refrigerant Gaz | R-290 | | | | | | | | | | | | | |
| Opcional Optional Options | Puertas correderas traseras / Rear sliding doors / Portes coulissantes arrière | | | | | | | | | | | | | |
| | R | 68 € | R | 105 € | R | 122 € | R | 119 € | R | 193 € | R | 227 € | R | 221 € |
| | P | 96 € | P | 120 € | P | 147 € | P | 174 € | P | 223 € | P | 277 € | P | 331 € |
| | Doble Plano / Double surface / Double plan | | | | | | | | | | | | | |
| | | 106 € | | 142 € | | 177 € | | 213 € | | 284 € | | 355 € | | 425 € |
| | Doble plano Inox / Stainless steel double surface / Double plan Inox | | | | | | | | | | | | | |
| | 186 € | | 249 € | | 311 € | | 373 € | | 497 € | | 622 € | | 746 € | |
| Control de Condensación SSC / SCC Condensing Control / Contrôle de la Condensation SCC | | | | | | | | | | | | | | |
| | 111 € | | 123 € | | 124 € | | 159 € | | 182 € | | 244 € | | 264 € | |

R: CRISTAL CURVO / CURVED GLASS / VITRE BOMBÉE
P: CRISTAL RECTO / FLAT GLASS / VITRE DROITE

Laterales no incluidos en el precio
Side panels not included in price
Joues non incluses dans le prix

Serie / Series / Série **VEX - EXPERIENCE**

+Info: www.infrico.com

VEX37UCP



Laterales / Sides / Joues

| NO | |
|-----------------------------|----------------------------|
| Izquierdo Left Gauche | Derecho Right Droite |
| CP: 378 € | CP: 378 € |
| 406 € | 406 € |

VEX37U

Ext. Estándar / Standar / Standard

| | | |
|------------------------|----------------------|---------------|
| Blanco/White/ Blanc | Ral 1015 | Ral 1018 |
| Ral 2003 | Ral 3003 | Ral 3020 |
| Ral 5015 | Ral 5017 | Ral 5011 |
| Ral 6002 | Ral 6018 | Ral 6019 |
| Ral 7035 | Ral 7037 | Ral 7042 |
| Ral 7016 | Negro/Black/ Noir | Roble natural |

Colores fuera de carta /
Colors outside of letter /
Couleurs spéciales, hors palette

| RAL | | NO RAL | |
|--|--------------------------------|---|--------------------------------|
| Epoxi | Líquida/ Liquid/ Liquide | Epoxi | Líquida/ Liquid/ Liquide |
| 817 € | 508 € | Consultar / Consultar / Consulter | |
| [x unidad/x unit/x unité] | | | |
| +10 días laborables / +10 work days / +10 jours ouvrés | | Consultar / Consultar / Consulter | |

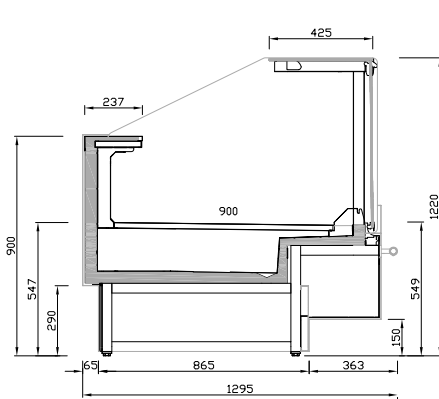



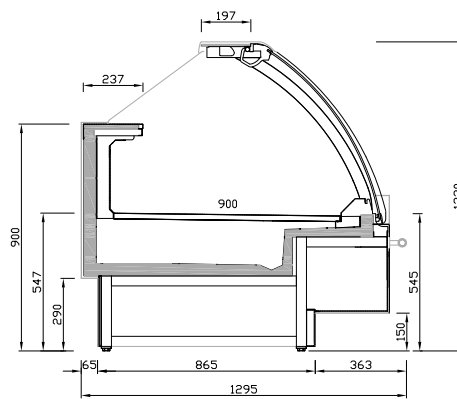

VEX UCP



VEX U

Vitrina Experience grupo incorporado / Plug in refrigerated display case Experience / Vitrine Experience groupe incorporé

| MODELO MODELE MODÈLE |  |  |  |  |  |
|---|--|--|--|--|--|
| | VEX09 U CB | VEX12 U CB | VEX15 U CB | VEX18 U CB | VEX25 U CB |
| Precio Price Prix | 3.532 € | 3.945 € | 4.333 € | 4.507 € | 5.367 € |
| MOD. | VEX09 IU CB | VEX12 IU CB | VEX15 IU CB | VEX18 IU CB | VEX25 IU CB |
| Precio PLANO INOX Price STAINL. STEEL SURF. Prix PLAN INOX | 3.625 € | 4.033 € | 4.463 € | 4.660 € | 5.591 € |
| Medidas Measures (mm) Mesures | 938 x 1225 x 875 mm. | 1250 x 1225 x 875 mm. | 1562 x 1225 x 875 mm. | 1875 x 1225 x 875 mm. | 2500 x 1225 x 875 mm. |
| Temperatura Temperature (°C) Température | -1°C/+7°C | | | | |
| Clase Climática Climatic class (°C) Classe climatique | 4 / 30°C | | | | |
| Tensión/Frecuencia Electrical data Tension électrique | 230V/1ph/50Hz | | | | |
| Controlador Controller Régulateur | Digital | | | | |
| Material Material (EXT/INT) Matériel | Ext + Costados/Sides/Joues: acero plastificado / Plastified steel / Acier plastifié Encimera / Worktop / Dessous: Inox Aisi 304 Plano exposición / Exhibition plan / Plan d'exposition: Acero plastif./ Plastif. steel/ Acier plastifié [Mod U/UCP] - Inox Aisi 304 [Mod. I] | | | | |
| Aislamiento Isolation (mm) Isolation | 40kg/m ³ / Free CFC's / Zero ODP-GWP | | | | |
| Capacidad Capacity (L) Capacité | 169 | 225 | 281 | 338 | 450 |
| Superficie exposición Surface exhibition (m ²) Surface d'exposition | 0,84 | 1,13 | 1,41 | 1,69 | 2,25 |
| Compresor Compressor (HP) Compresseur | 3/4 | 3/4 | 1 | 1 | 1 1/4 |
| Costados [2] Sides [2] Joues [2] | 30 + 30 | | | | |
| Sistema de frío Cooling System Système de froid | Ventilado / Ventilated / Ventilé | | | | |
| Desescarche Defrost Dégivrage | Automático / Automatic / Automatique | | | | |
| Evaporación Evaporation Évaporation | Forzada / Forced / Ventilé | | | | |
| Potencia Power (W) Puissance | 503 | 590 | 682 | 780 | 1005 |
| Potencia frig. Cooling capacity (W A -10°C) Puissance Frig. | - | | | | |
| Consumo Consumption (kWh/ 24h) Consommation | 6,64 | 7,80 | 9,10 | 9,80 | 13,3 |
| Refrigerante Refrigerant Gaz | R-290 | | | | |
| Opcional Optional Options | Doble Plano / Double surface / Double plan 106 € | Doble Plano / Double surface / Double plan 142 € | Doble Plano / Double surface / Double plan 177 € | Doble Plano / Double surface / Double plan 213 € | Doble Plano / Double surface / Double plan 284 € |
| | Doble plano Inox / Stainl. steel double surface / Double plan Inox 186 € | Doble plano Inox / Stainl. steel double surface / Double plan Inox 249 € | Doble plano Inox / Stainl. steel double surface / Double plan Inox 311 € | Doble plano Inox / Stainl. steel double surface / Double plan Inox 373 € | Doble plano Inox / Stainl. steel double surface / Double plan Inox 497 € |

Laterales no incluidos en el precio
Side panels not included in price
Joues non incluses dans le prix

Serie / Series / Série **VEX - EXPERIENCE**

+Info: www.infrico.com

VEX25UCB



Laterales / Sides / Jous

| NO | |
|-----------------------------|----------------------------|
| Izquierdo Left Gauche | Derecho Right Droite |
| CB: 334 € | CB: 334 € |

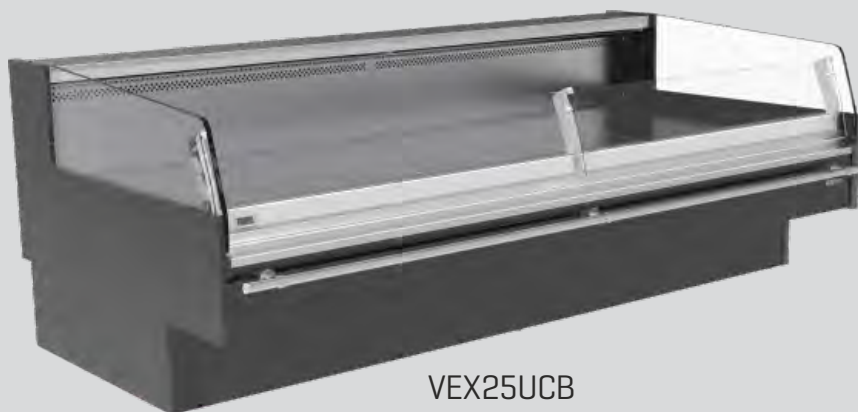

VEX25UCB

Ext. Estándar / Standar / Standard

| | | |
|------------------------|----------------------|---------------|
| Blanco/White/ Blanc | Ral 1015 | Ral 1018 |
| Ral 2003 | Ral 3003 | Ral 3020 |
| Ral 5015 | Ral 5017 | Ral 5011 |
| Ral 6002 | Ral 6018 | Ral 6019 |
| Ral 7035 | Ral 7037 | Ral 7042 |
| Ral 7016 | Negro/Black/ Noir | Roble natural |

Colores fuera de carta / Colors outside of letter / Couleurs spéciales, hors palette



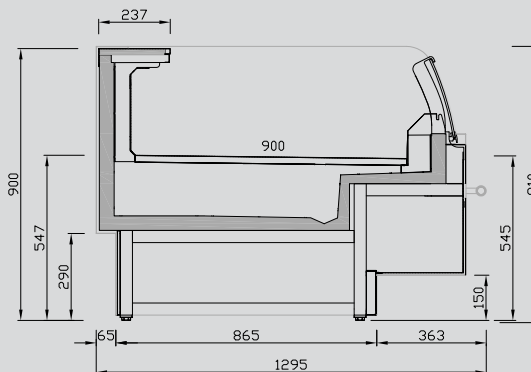

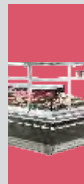

| RAL | | NO RAL | |
|--|--------------------------------|---|--------------------------------|
| Epoxi | Líquida/ Liquid/ Liquide | Epoxi | Líquida/ Liquid/ Liquide |
| 817 € | 508 € | Consultar / Consultar / Consulter | |
| [x unidad/x unit/x unité] | | | |
| +10 días laborables / +10 work days / +10 jours ouvrés | | Consultar / Consultar / Consulter | |



VEX UCB



Vitrina Experience grupo incorporado / Plug in refrigerated display case Experience / Vitrine Experience groupe incorporé

| MODELO MODELE MODÈLE |  |  |  |  |  |  |
|---|--|---|---|---|---|---|
| | VEX 90 AC U | VEX 90 AA U | VEX 45 AC U | VEX 45 AA | VEX 90 AC UCP | VEX 90 AA UCP |
| Precio Price Prix | 9.259 € | 7.518 € | 6.477 € | NEUTRO/NEUTRAL/NEUTRE 5.295 € | 9.441 € | 6.828 € |
| MOD. | VEX 90 AC IU | VEX 90 AA IU | VEX 45 AC IU | VEX 45 AA I | VEX 90 AC IUCP | VEX 90 AA IUCP |
| Precio PLANO INOX Price STAINL.STEEL SURF. Prix PLAN INOX | 9.848 € | 7.782 € | 6.586 € | NEUTRO/NEUTRAL/NEUTRE 5.311 € | 9.711 € | 7.065 € |
| Medidas Measures (mm) Mesures | 2769 x 1225 x 1220 mm. | 1882 x 1225 x 1220 mm. | 1531 x 1225 x 1220 mm. | 1050 x 1225 x 1220 mm. | 2769 x 1225 x 1220 mm. | 1882 x 1225 x 1220 mm. |
| Temperatura Temperature (°C) Température | -1°C/+5°C | | | | | |
| Clase Climática Climatic class (°C) Classe climatique | 4 / 30°C | | | | | |
| Tensión/Frecuencia Electrical data Tension électrique | 230V/1ph/50Hz | | | | | |
| Controlador Controller Régulateur | Digital | | | | | |
| Material Material (EXT/INT) Matériel | Ext + Costados/Sides/Joues: acero plastificado / Plastified steel / Acier plastifié Encimera / Worktop / Dessous: Inox Aisi 304 Plano exposición / Exhibition plan / Plan d'exposition: Acero plastif./ Plastif. steel/ Acier plastifié (Mod U/UCP) - Inox Aisi 304 (Mod. I) | | | | | |
| Aislamiento Isolation (mm) Isolation | 40kg/m ³ / Free CFC's / Zero ODP-GWP | | | | | |
| Capacidad Capacity (L) Capacité | 456 | 205 | - | - | 456 | 205 |
| Superficie exposición Surface exhibition (m ²) Surface d'exposition | 1,85 | 1,10 | 0,92 | 0,60 | 1,85 | 1,10 |
| Compresor Compressor (HP) Compresseur | 1/2 | 1/2 | - | Sin unidad Without unity Sans unité | 1/2 | 1/2 |
| Estantes Shelving Étagères | - | | | | | |
| Costados [2] Sides [2] (mm) Joues [2] | 30+30 | | | | | |
| Sistema de frío Cooling System Système de froid | Ventilado / Ventilated / Ventilé | | | | | |
| Desescarche Defrost Dégivrage | Automático / Automatic / Automatique | | | | | |
| Evaporación Evaporation Évaporation | Forzada / Forced / Ventilé | | | | | |
| Potencia Power (W) Puissance | 830 | 768 | 663 | 35 | 830 | 768 |
| Potencia frig. Cooling capacity (W A -10°C) Puissance Frig. | - | - | - | Sin unidad Without unity Sans unité | - | - |
| Consumo Consumption (kWh/24h) Consommation | 1,1 | 1,3 | 0,5 | 0,5 | 1,1 | 1,3 |
| Refrigerante Refrigerant Gaz | R-290 | | | | | |
| Opcional Optional Options | Doble plano [sin reserva] / Double surface [without storage] / Double plan [sans réserve] - Modelo/Model/Modèle I: Inox | | | | | |
| | 180 € | 122 € | 114 € | 76 € | 180 € | 122 € |
| | I: 403 € | I: 193 € | I: 218 € | I: 110 € | I: 403 € | I: 193 € |
| | Puertas correderas traseras / Rear sliding doors / Portes coulissantes arrière | | | | | |
| | 363 € | 59 € | 190 € | 38 € | 213 € | 181 € |

Laterales no incluidos en el precio
Side panels not included in price
Joues non incluses dans le prix

Serie / Series / Série **VEX - EXPERIENCE**

+Info: www.infrico.com

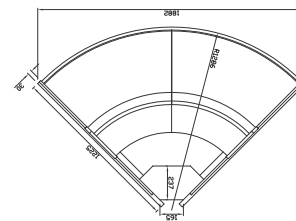
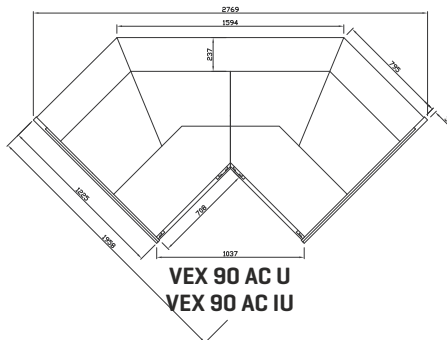

Laterales / Sides / Jouses

| NO | |
|-----------------------------|----------------------------|
| Izquierdo Left Gauche | Derecho Right Droite |
| Curvo: 406 € | Curvo: 406 € |
| Plano: 378 € | Plano: 378 € |

Ext. Estándar / Standar / Standard

| | | |
|------------------------|----------------------|---------------|
| Blanco/White/ Blanc | Ral 1015 | Ral 1018 |
| Ral 2003 | Ral 3003 | Ral 3020 |
| Ral 5015 | Ral 5017 | Ral 5011 |
| Ral 6002 | Ral 6018 | Ral 6019 |
| Ral 7035 | Ral 7037 | Ral 7042 |
| Ral 7016 | Negro/Black/ Noir | Roble natural |

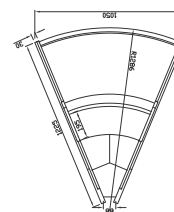
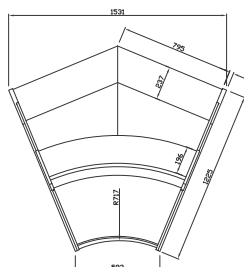





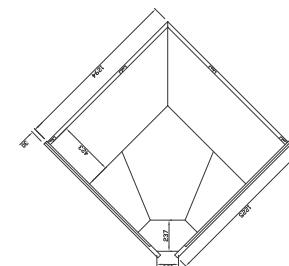
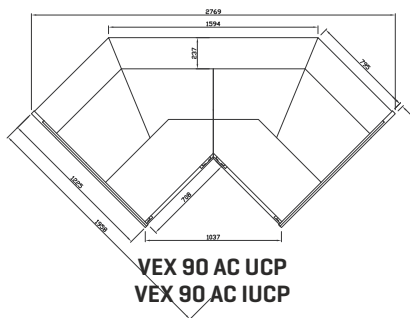

**Colores fuera de carta /
Colors outside of letter /
Couleurs spéciales, hors palette**

| RAL | | NO RAL | |
|--|--------------------------------|---|--------------------------------|
| Epoxi | Líquida/ Liquid/ Liquide | Epoxi | Líquida/ Liquid/ Liquide |
| 817 € | 508 € | Consultar / Consultar / Consulter | |
| [x unidad/x unit/x unité] | | | |
| +10 días laborables / +10 work days / +10 jours ouvrés | | Consultar / Consultar / Consulter | |



Vitr. Experience torre de carne /
Meat tower Experience display counter /
Vitrine Experience tour de viande

Vitrina Experience caliente /
Experience hot display counter /
Vitrine Experience chaude

| MODELO MODELE MODÈLE | REMOTA / REMOTE / GROUPE À DIST. | | GRUPO INCORP. / PLUG IN / GR. INCORPORÉ | | CALIENTE / HOT / CHAUDE | | | | | | | |
|---|--|--|--|--|---|---|--------------------------|--|---|---------------|---------------------------|--|
| |  VEX09 CA |  VEX12 CA |  VEX09 U CA |  VEX12 U CA |  VEX12 CP HT |  VEX25 CP HT | | | | | | |
| Precio Price Prix | 5.993 € | | 6.397 € | | 6.599 € | | 7.064 € | | 5.651 € | | 8.608 € | |
| Medidas Measures Mesures [mm] | Sin costados Without sides Sans joues 938 x 930 x 1500 mm. | | Sin costados Without sides Sans joues 1250 x 930 x 1500 mm. | | 938 x 930 x 1500 mm. | | 1250 x 930 x 1500 mm. | | 1250 x 1225 x 1220 mm. | | 2500 x 1225 x 1220 mm. | |
| Temperatura Temperature Température [°C] | -1°C/+5°C | | | | | | +65°C | | | | | |
| Clase Climática Climatic class Classe climatique [°C] | 4 / 30°C | | | | | | | | | | | |
| Tensión/Frecuencia Electrical data Tension électrique | 230V/1ph/50Hz | | | | | | | | | 380V/3ph/50Hz | | |
| Controlador Controller Régulateur | Digital | | | | | | | | | | | |
| Material Matériel [EXT/INT] | Ext + Costados/Sides/Joues: acero plastificado / Plastified steel / Acier plastifié Encimera / Worktop / Dessous: Inox Aisi 304 Plano exposición / Exhibition plan / Plan d'exposition: Acero plastif./ Plastif. steel/ Acier plastifié (Mod U/UCP) - Inox Aisi 304 (Mod. I) | | | | | | | | | | | |
| Aislamiento Isolation Isolation [mm] | 40kg/m ³ / Free CFC's / Zero ODP-GWP | | | | | | | | | | | |
| Capacidad Capacity Capacité [L] | 190 | | 253 | | 190 | | 253 | | 225 | | 450 | |
| Superficie exposición Surface exhibition Surface d'exposition [m ²] | 1,08 | | 1,44 | | 1,08 | | 1,44 | | 1,13 | | 2,25 | |
| Compresor Compressor Compresseur [HP] | - | | | | 3 1/4 | | 1 1/4 | | - | | | |
| Estantes Shelving Étagères | 2 | | | | | | - | | | | | |
| Costados [2] Sides [2] Joues [2] [mm] | 30+30 | | | | Laterales NO incluidos NOT Side panels included NON Joues inclus | | | | Laterales incluidos Side panels included Joues inclus | | | |
| Sistema de frío Cooling System Système de froid | Ventilado / Ventilated / Ventilé | | | | | | - | | | | | |
| Desescarche Defrost Dégivrage | Automático / Automatic / Automatique | | | | | | - | | | | | |
| Evaporación Evaporation Évaporation | Forzada / Forced / Ventilé | | | | | | - | | | | | |
| Potencia Power Puissance [W] | - | | | | 784 | | 893 | | 2153 | | 4305 | |
| Potencia frig. Cooling capacity Puissance Frig. [W A -10°C] | 1500 | | 2200 | | - | | | | | | | |
| Consumo Consumption Consommation [kWh/ 24h] | - | | | | 12,1 | | 14,3 | | 12,9 | | 25,8 | |
| Refrigerante Refrigerant Gaz | FREON | | | | R-290 | | | | - | | | |
| Opcional Optional Options | Separador panorámico / Panoramic divider / Séparateur panoramique | | | | | | - | | | | | |
| | 545 € | | | | | | | | | | | |

Laterales no incluidos en el precio
Side panels not included in price
Joues non incluses dans le prix

Serie / Series / Série **VEX - EXPERIENCE**

+Info: www.infrico.com

VEX25 CP HT

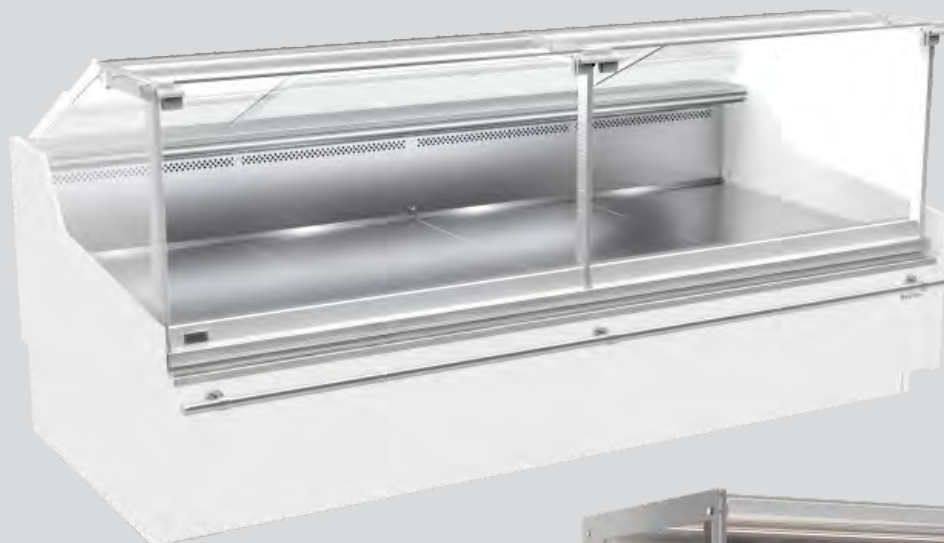

Laterales / Sides / Joutes

| | |
|--------------------------------------|--|
| VEX / CP HT | |
| Incluidos / Includes / Inclus | |

Laterales / Sides / Joutes VEX CA/UCA

| | |
|-----------------------------|----------------------------|
| NO | |
| Izquierdo Left Gauche | Derecho Right Droite |
| CA: 414 € | CA: 414 € |



VEX12 CA

Ext. Estándar / Standar / Standard

| | | |
|------------------------|----------------------|---------------|
| Blanco/White/ Blanc | Ral 1015 | Ral 1018 |
| Ral 2003 | Ral 3003 | Ral 3020 |
| Ral 5015 | Ral 5017 | Ral 5011 |
| Ral 6002 | Ral 6018 | Ral 6019 |
| Ral 7035 | Ral 7037 | Ral 7042 |
| Ral 7016 | Negro/Black/ Noir | Roble natural |

**Colores fuera de carta /
Colors outside of letter /
Couleurs spéciales, hors palette**

| RAL | | NO RAL | |
|--|--------------------------------|---|--------------------------------|
| Epoxi | Líquida/ Liquid/ Liquide | Epoxi | Líquida/ Liquid/ Liquide |
| 817 € | 508 € | Consultar / Consultar / Consultar | |
| [x unidad/x unit/x unité] | | | |
| +10 días laborables / +10 work days / +10 jours ouvrés | | Consultar / Consultar / Consultar | |

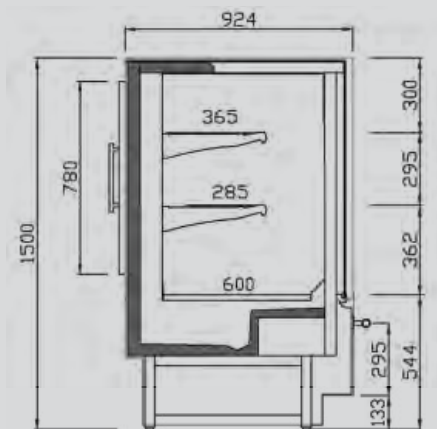



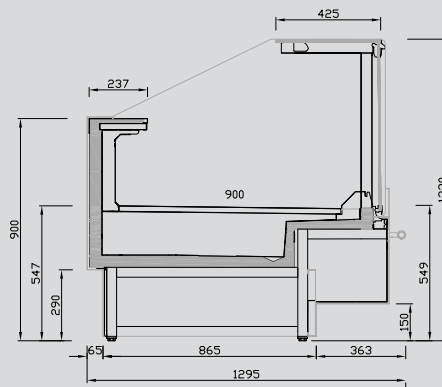



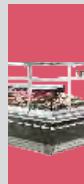







VEX CA



VEX CP HT



Vitrina Experience remota / Experience refrigerated self service remote case / Vitrine Experience groupe à distance

| | | CRISTAL RECTO / FLAT GLASS / VITRE DROITE | | | | | | | | | | | | |
|--|---|---|---|---|---|---|---|--------------|---|--------------|---|--------------|---|--------------|
| MODELO MODELE MODÈLE |  |  |  |  |  |  |  | | | | | | | |
| Precio Price Prix | 3.661 € | 3.885 € | 4.269 € | 4.624 € | 5.661 € | 6.602 € | 7.155 € | | | | | | | |
| MOD. | VEX09 I CP | VEX12 I CP | VEX15 I CP | VEX18 I CP | VEX25 I CP | VEX31 I CP | VEX37 I CP | | | | | | | |
| Precio PLANO INOX Price STAINL. STEEL SURF. Prix PLAN INOX | 3.718 € | 3.984 € | 4.421 € | 4.761 € | 5.880 € | 7.055 € | 7.690 € | | | | | | | |
| | | CRISTAL CURVO / CURVED GLASS / VITRE BOMBÉE | | | | | | | | | | | | |
| MODELO MODELE MODÈLE |  |  |  |  |  |  |  | | | | | | | |
| Precio Price Prix | 3.490 € | 3.936 € | 4.185 € | 4.437 € | 5.729 € | 6.633 € | 7.372 € | | | | | | | |
| MOD. | VEX09 I | VEX12 I | VEX15 I | VEX18 I | VEX25 I | VEX31 I | VEX37 I | | | | | | | |
| Precio PLANO INOX Price STAINL. STEEL SURF. Prix PLAN INOX | 3.547 € | 4.032 € | 4.314 € | 4.642 € | 5.934 € | 6.825 € | 7.649 € | | | | | | | |
| Medidas / Measures / Mesures / (mm) Sin costados / Without sides / Sans joues | 938 x 1295 x 1220 mm. | 1250 x 1295 x 1220 mm. | 1562 x 1295 x 1220 mm. | 1875 x 1295 x 1220 mm. | 2500 x 1295 x 1220 mm. | 3125 x 1295 x 1220 mm. | 3750 x 1295 x 1220 mm. | | | | | | | |
| Temperatura Temperature Température | -1°C/+5°C | | | | | | | | | | | | | |
| Clase Climática Climatic class Classe climatique | 4 / 30°C | | | | | | | | | | | | | |
| Tensión/Frecuencia Electrical data Tension électrique | 230V/1ph/50Hz | | | | | | | | | | | | | |
| Controlador Controller Régulateur | Digital | | | | | | | | | | | | | |
| Material Matériel (EXT/INT) | Ext + Costados/Sides/Joues: acero plastificado / Plastified steel / Acier plastifié Encimera / Worktop / Dessous: Inox Aisi 304 Plano exposición / Exhibition plan / Plan d'exposition: Acero plastif./Plastif. steel/ Acier plastifié (Mod U/UCP) - Inox Aisi 304 (Mod. I) | | | | | | | | | | | | | |
| Aislamiento Isolation Isolation | 40kg/m³ / Free CFC's / Zero ODP-GWP | | | | | | | | | | | | | |
| Capacidad Capacity Capacité | 169 | 225 | 281 | 338 | 450 | 563 | 675 | | | | | | | |
| Superficie exposición Surface exhibition Surface d'exposition | 0,84 | 1,13 | 1,41 | 1,69 | 2,25 | 2,81 | 3,40 | | | | | | | |
| Compresor Compressor Compresseur | - | | | | | | | | | | | | | |
| Costados (2) Sides (2) Joues (2) | 30 + 30 | | | | | | | | | | | | | |
| Sistema de frío Cooling System Système de froid | Ventilado / Ventilated / Ventilé | | | | | | | | | | | | | |
| Desescarche Defrost Dégivrage | Automático / Automatic / Automatique | | | | | | | | | | | | | |
| Evaporación Evaporation Evaporation | Forzada / Forced / Ventilé | | | | | | | | | | | | | |
| Potencia frig. Cooling capacity Puissance Frig. (W A -10°C) | 610 | 813 | 1015 | 1219 | 1626 | 2031 | 2438 | | | | | | | |
| Refrigerante Refrigerant Gaz | FREON | | | | | | | | | | | | | |
| Opcional Optional Options | Puertas correderas traseras / Rear sliding doors / Portes coulissantes arrière | | | | | | | | | | | | | |
| | R | 68 € | R | 105 € | R | 122 € | R | 119 € | R | 193 € | R | 227 € | R | 221 € |
| | P | 96 € | P | 120 € | P | 147 € | P | 174 € | P | 223 € | P | 277 € | P | 331 € |
| | Doble Plano / Double surface / Double plan | | | | | | | | | | | | | |
| | | 106 € | | 142 € | | 177 € | | 213 € | | 284 € | | 355 € | | 425 € |
| | Doble plano Inox / Stainless steel double surface / Double plan Inox | | | | | | | | | | | | | |
| | | 186 € | | 249 € | | 311 € | | 373 € | | 497 € | | 622 € | | 746 € |
| | Control de Condensación SSC / SCC Condensing Control / Contrôle de la Condensation SCC | | | | | | | | | | | | | |
| | | 111 € | | 123 € | | 124 € | | 159 € | | 182 € | | 244 € | | 264 € |

R: CRISTAL CURVO / CURVED GLASS / VITRE BOMBÉE
P: CRISTAL RECTO / FLAT GLASS / VITRE DROITE

Laterales no incluidos en el precio
Side panels not included in price
Joues non incluses dans le prix

Serie / Series / Série **VEX - EXPERIENCE**

+Info: www.infrico.com

VEX25CP



Laterales / Sides / Joues

| NO | |
|-----------------------------|----------------------------|
| Izquierdo Left Gauche | Derecho Right Droite |
| CP: 378 € | CP: 378 € |
| 406 € | 406 € |



VEX25

Ext. Estándar / Standar / Standard

| | | |
|------------------------|----------------------|----------|
| Blanco/White/ Blanc | Ral 1015 | Ral 1018 |
| Ral 2003 | Ral 3003 | Ral 3020 |
| Ral 5015 | Ral 5017 | Ral 5011 |
| Ral 6002 | Ral 6018 | Ral 6019 |
| Ral 7035 | Ral 7037 | Ral 7042 |
| Ral 7016 | Negro/Black/ Noir | |

Colores fuera de carta /
Colors outside of letter /
Couleurs spéciales, hors palette

| RAL | | NO RAL | |
|--|--------------------------------|---|--------------------------------|
| Epoxi | Líquida/ Liquid/ Liquide | Epoxi | Líquida/ Liquid/ Liquide |
| 817 € | 508 € | Consultar / Consultar / Consulter | |
| [x unidad/x unit/x unité] | | | |
| +10 días laborables / +10 work days / +10 jours ouvrés | | Consultar / Consultar / Consulter | |

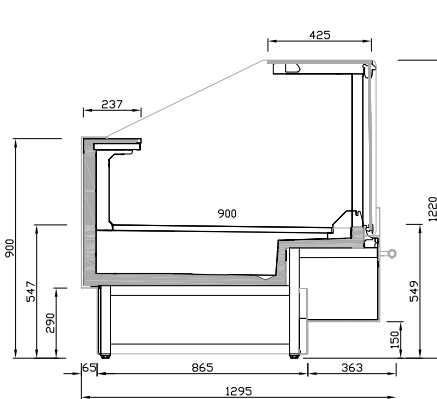



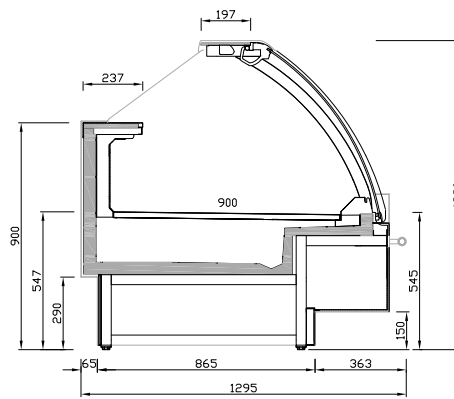

VEX CP



VEX



Vitrina Experience remota / Experience refrigerated self service remote case / Vitrine Experience groupe à distance

| MODELO MODELE MODÈLE |  VEX09 CB |  VEX12 CB |  VEX15 CB |  VEX18 CB |  VEX25 CB |
|--|--|--|--|--|--|
| Precio Price Prix | 3.302€ | 3.658 € | 4.047 € | 4.182 € | 4.960 € |
| MOD. | VEX09 CB | VEX12 CB | VEX15 CB | VEX18 CB | VEX25 CB |
| Precio PLANO INOX Price STAINL. STEEL SURF. Prix PLAN INOX | 3.395 € | 3.746 € | 4.176 € | 4.335 € | 5.185 € |
| Medidas / Measures / Mesures / [mm] Sin costados / Without sides / Sans joues | 938 x 1225 x 875 mm. | 1250 x 1225 x 875 mm. | 1562 x 1225 x 875 mm. | 1875 x 1225 x 875 mm. | 2500 x 1225 x 875 mm. |
| Temperatura Temperature [°C] Température | -1°C/+7°C | | | | |
| Clase Climática Climatic class [°C] Classe climatique | 4 / 30°C | | | | |
| Tensión/Frecuencia Electrical data Tension électrique | 230V/1ph/50Hz | | | | |
| Controlador Controller Régulateur | Digital | | | | |
| Material Material [EXT/INT] Matériel | Ext + Costados/Sides/Joues: acero plastificado / Plastified steel / Acier plastifié Encimera / Worktop / Dessous: Inox Aisi 304 Plano exposición / Exhibition plan / Plan d'exposition: Acero plastif./ Plastif. steel/ Acier plastifié [Mod U/UCP] - Inox Aisi 304 [Mod. I] | | | | |
| Aislamiento Isolation [mm] Isolation | 40kg/m ³ / Free CFC's / Zero ODP-GWP | | | | |
| Capacidad Capacity [L] Capacité | 169 | 225 | 281 | 338 | 450 |
| Superficie exposición Surface exhibition [m ²] Surface d'exposition | 0,84 | 1,13 | 1,41 | 1,69 | 2,25 |
| Compresor Compressor [HP] Compresseur | - | | | | |
| Costados [2] Sides [2] Joues [2] | 30 + 30 | | | | |
| Sistema de frío Cooling System Système de froid | Ventilado / Ventilated / Ventilé | | | | |
| Desescarche Defrost Dégivrage | Automático / Automatic / Automatique | | | | |
| Evaporación Evaporation Evaporation | Forzada / Forced / Ventilé | | | | |
| Potencia Power [W] Puissance | - | | | | |
| Potencia frig. Cooling capacity [W A -10°C] Puissance Frig. | 750 | 1000 | 1250 | 1500 | 2000 |
| Consumo Consumption [kWh/ 24h] Consommation | - | | | | |
| Refrigerante Refrigerant Gaz | FREON | | | | |
| Opcional Optional Options | Doble Plano / Double surface / Double plan 106 € | Doble Plano / Double surface / Double plan 142 € | Doble Plano / Double surface / Double plan 177 € | Doble Plano / Double surface / Double plan 213 € | Doble Plano / Double surface / Double plan 284 € |
| | Doble plano Inox / Stainl. steel double surface / Double plan Inox 186 € | Doble plano Inox / Stainl. steel double surface / Double plan Inox 249 € | Doble plano Inox / Stainl. steel double surface / Double plan Inox 311 € | Doble plano Inox / Stainl. steel double surface / Double plan Inox 373 € | Doble plano Inox / Stainl. steel double surface / Double plan Inox 497 € |

Laterales no incluidos en el precio
Side panels not included in price
Joues non incluses dans le prix

Serie / Series / Série **VEX - EXPERIENCE**

+Info: www.infrico.com

VEX25CB



Laterales / Sides / Joues

| NO | |
|-----------------------------|----------------------------|
| Izquierdo Left Gauche | Derecho Right Droite |
| CB: 334 € | CB: 334 € |

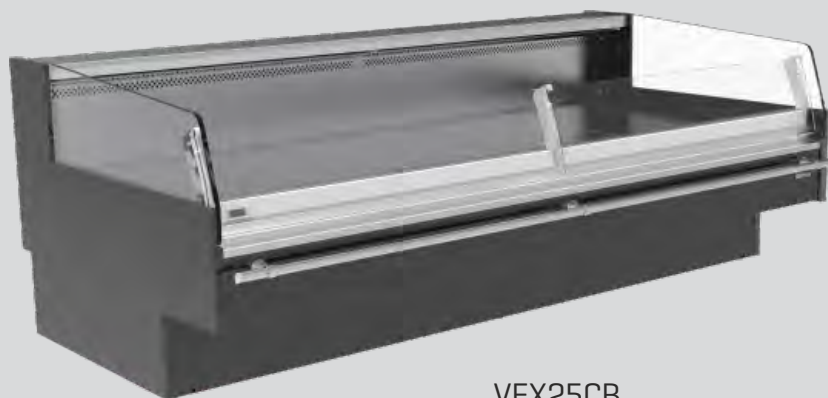

VEX25CB

Ext. Estándar / Standar / Standard

| | | |
|------------------------|----------------------|----------|
| Blanco/White/ Blanc | Ral 1015 | Ral 1018 |
| Ral 2003 | Ral 3003 | Ral 3020 |
| Ral 5015 | Ral 5017 | Ral 5011 |
| Ral 6002 | Ral 6018 | Ral 6019 |
| Ral 7035 | Ral 7037 | Ral 7042 |
| Ral 7016 | Negro/Black/ Noir | |

Colores fuera de carta / Colors outside of letter / Couleurs spéciales, hors palette



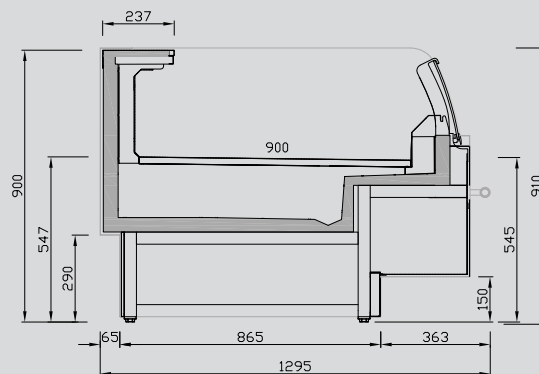

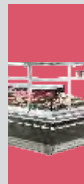

| RAL | | NO RAL | |
|--|--------------------------------|---|--------------------------------|
| Epoxi | Líquida/ Liquid/ Liquide | Epoxi | Líquida/ Liquid/ Liquide |
| 817 € | 508 € | Consultar / Consultar / Consulter | |
| [x unidad/x unit/x unité] | | | |
| +10 días laborables / +10 work days / +10 jours ouvrés | | Consultar / Consultar / Consulter | |



VEX CB



Vitrina Experience remota / Experience refrigerated self service remote case / Vitrine Experience groupe à distance

| | ÁNGULOS / ANGLES / ANGLES | | | | | |
|--|--|---|---|---|---|---|
| MODELO MODELE MODÈLE |  |  |  |  |  |  |
| | VEX 90 AC | VEX 90 AA | VEX 45 AC | VEX 45 AA | VEX 90 AC CP | VEX 90 AA CP |
| Precio Price Prix | 8.974 € | 7.233 € | 6.193 € | 5.295 € | 9.156 € | 6.544 € |
| MOD. | VEX 90 ACI | VEX 90 AAI | VEX 45 ACI | VEX 45 AAI | VEX 90 AC I CP | VEX 90 AA I CP |
| Precio PLANO INOX Price STAINL.STEEL SURF. Prix PLAN INOX | 9.563 € | 7.497 € | 6.301 € | 5.311 € | 9.427 € | 6.781 € |
| Medidas / Measures / Mesures / [mm] Sin costados / Without sides / Sans joues | 2769 x 1225 x 1220 mm. | 1882 x 1225 x 1220 mm. | 1531 x 1225 x 1220 mm. | 1050 x 1225 x 1220 mm. | 2769 x 1225 x 1220 mm. | 1882 x 1225 x 1220 mm. |
| Temperatura Temperature [°C] Température | -1°C/+7°C | | | | | |
| Clase Climática Climatic class [°C] Classe climatique | 4 / 30°C | | | | | |
| Tensión/Frecuencia Electrical data Tension électrique | 230V/1ph/50Hz | | | | | |
| Controlador Controller Régulateur | Digital | | | | | |
| Material Material [EXT/INT] | Ext + Costados/Sides/Joues: acero plastificado / Plastified steel / Acier plastifié Encimera / Worktop / Dessous: Inox Aisi 304 Plano exposición / Exhibition plan / Plan d'exposition: Acero plastif./ Plastif. steel/ Acier plastifié [Mod U/UCP] - Inox Aisi 304 [Mod. I] | | | | | |
| Aislamiento Isolation [mm] | 40kg/m ³ / Free CFC's / Zero ODP-GWP | | | | | |
| Capacidad Capacity [L] Capacité | 456 | 205 | - | - | 456 | 205 |
| Superficie exposición Surface exhibition [m ²] Surface d'exposition | 1,85 | 1,10 | 0,92 | 0,60 | 1,85 | 1,10 |
| Compresor Compressor [HP] Compresseur | - | | | | | |
| Estantes Shelving Étagères | - | | | | | |
| Costados [2] Sides [2] [mm] Joues [2] | 30+30 | | | | | |
| Sistema de frío Cooling System Système de froid | Ventilado / Ventilated / Ventilé | | | | | |
| Desescarche Defrost Dégivrage | Automático / Automatic / Automatique | | | | | |
| Evaporación Evaporation Évaporation | Forzada / Forced / Ventilé | | | | | |
| Potencia Power [W] Puissance | - | | | | | |
| Potencia frig. Cooling capacity [W A -10°C] Puissance Frig. | 1700 | 855 | 852 | NEUTRO | 1790 | 900 |
| Consumo Consumption [kWh/ 24h] Consommation | - | | | | | |
| Refrigerante Refrigerant Gaz | FREON | | | | | |
| Opcional Optional Options | Doble plano [sin reserva] / Double surface [without storage] / Double plan [sans réserve] - Modelo/Model/Modèle I: Inox | | | | | |
| | 180 € | 122 € | 114 € | 76 € | 180 € | 122 € |
| | I: 403 € | I: 193 € | I: 218 € | I: 110 € | I: 403 € | I: 193 € |
| | Puertas correderas traseras / Rear sliding doors / Portes coulissantes arrière | | | | | |
| | 363 € | 59 € | 190 € | 38 € | 213 € | 181 € |
| Opcional Optional Options | Control de Condensación SSC / SCC Condensing Control / Contrôle de la Condensation SCC | | | | | |
| | 153 € | 174 € | 95 € | 116 € | 153 € | 174 € |

Laterales no incluidos en el precio
Side panels not included in price
Joues non incluses dans le prix

Serie / Series / Série **VEX - EXPERIENCE**

+Info: www.infrico.com

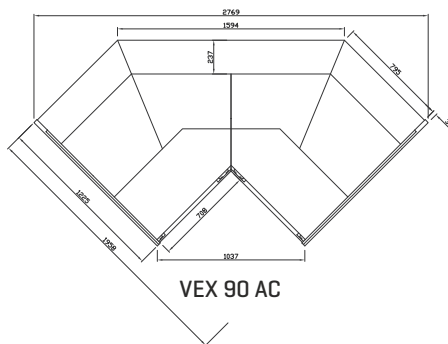

VEX 90 AC

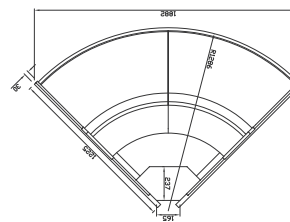

VEX 90 AA

Laterales / Sides / Joues

| NO | |
|-----------------------------|----------------------------|
| Izquierdo Left Gauche | Derecho Right Droite |
| AA/AC: 406 € | AA/AC: 406 € |
| CP: 378 € | CP: 378 € |

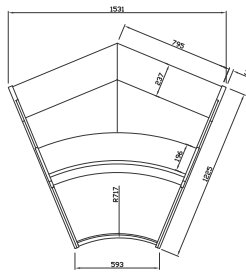

VEX 45 AC

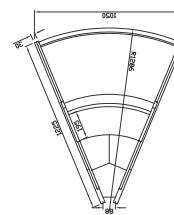

VEX 45 AA

Ext. Estándar / Standar / Standard

| | | |
|------------------------|----------------------|----------|
| Blanco/White/ Blanc | Ral 1015 | Ral 1018 |
| Ral 2003 | Ral 3003 | Ral 3020 |
| Ral 5015 | Ral 5017 | Ral 5011 |
| Ral 6002 | Ral 6018 | Ral 6019 |
| Ral 7035 | Ral 7037 | Ral 7042 |
| Ral 7016 | Negro/Black/ Noir | |

**Colores fuera de carta /
Colors outside of letter /
Couleurs spéciales, hors palette**

| RAL | | NO RAL | |
|--|--------------------------------|---|--------------------------------|
| Epoxi | Líquida/ Liquid/ Liquide | Epoxi | Líquida/ Liquid/ Liquide |
| 817 € | 508 € | Consultar / Consultar / Consulter | |
| [x unidad/x unit/x unité] | | | |
| +10 días laborables / +10 work days / +10 jours ouvrés | | Consultar / Consultar / Consulter | |

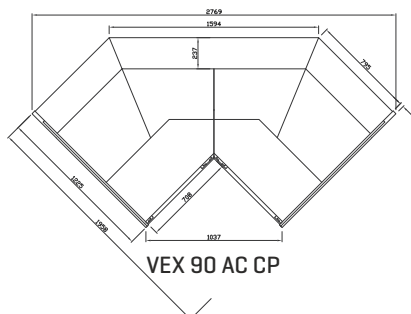



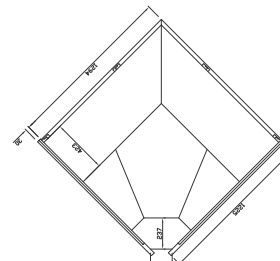

VEX 90 AC CP



VEX 90 AA CP

Vitrina estrecha remota Take Away /
Narrow remote Take Away refriger. display counter /
Vitrine étroite Take Away groupe à distance

Vitr. Experience torre de carne /
Meat tower Experience display counter /
Vitrine Experience tour de viande

| MODELO MODELE MODÈLE |  VEE 12 |  VEE 18 |  VEE 25 |  VEE 09 CA |  VEE 12 CA |
|--|--|--|---|---|---|
| Precio Price Prix | 2.926 € | 3.528 € | 4.040 € | 5.946 € | 6.340 € |
| Medidas / Measures / Mesures / (mm) Sin costados / Without sides / Sans joues | 1250 x 930 x 1220 mm. | 1875 x 930 x 1220 mm. | 2500 x 930 x 1220 mm. | 938 x 930 x 1500 mm. | 1250 x 930 x 1500 mm. |
| Temperatura Temperature Température (°C) | -1°C/+5°C | | | | |
| Clase Climática Climatic class Classe climatique (°C) | 4 / 30°C | | | | |
| Tensión/Frecuencia Electrical data Tension électrique | 230V/1ph/50Hz | | | | |
| Controlador Controller Régulateur | Digital | | | | |
| Material Material Matériel (EXT/INT) | Ext: acero plastificado / Plastified stainless steel / Acier plastifié Encimera / Worktop / Dessous: Inox Aisi 304 Plano exposición / Exhibition plan / Plan d'exposition: Inox Aisi 304 | | | | |
| Aislamiento Isolation Isolation (mm) | 40kg/m ³ / Free CFC's / Zero ODP-GWP | | | | |
| Capacidad Capacity Capacité (L) | 225 | 338 | 450 | 312 | 416 |
| Superficie exposición Surface exhibition Surface d'exposition (m ²) | 0,75 | 1,13 | 1,50 | 1,14 | 1,51 |
| Compresor Compressor Compresseur (HP) | - | | | | |
| Costados (2) Sides (2) Joues (2) (mm) | 30 + 30 | | | | |
| Sistema de frío Cooling System Système de froid | Ventilado / Ventilated / Ventilé | | | | |
| Desescarche Defrost Dégivrage | Automático / Automatic / Automatique | | | Gas caliente / hot gas / Gaz chaud | |
| Evaporación Evaporation Évaporation | Forzada / Forced / Ventilé | | | | |
| Potencia Power Puissance (W) | - | | | | |
| Potencia frig. Cooling capacity Puissance Frig. (W A -10°C) | 723 | 1164 | 1598 | 1453 | 1598 |
| Consumo Consumption Consommation (kWh/ 24h) | - | | | | |
| Refrigerante Refrigerant Gaz | R-290 | | | | |
| Opcional Optional Options | <p>Puertas correderas / Sliding doors / Portes coulissantes</p> <p>VEE 12 105 €</p> <p>VEE 18 122 €</p> <p>VEE 25 163 €</p> | | | | |

Laterales no incluidos en el precio
Side panels not included in price
Joues non incluses dans le prix

Serie / Series / Série **VEE - CALIFORNIA**

+Info: www.infrico.com

VEE25



Laterales / Sides / Joues

| NO | |
|-----------------------------|----------------------------|
| Izquierdo Left Gauche | Derecho Right Droite |
| VEE: 374 € | VEE: 374 € |
| VEE CA: 414 € | VEE CA: 414 € |

Ext. Estándar / Standar / Standard

| | | |
|------------------------|----------------------|----------|
| Blanco/White/ Blanc | Ral 1015 | Ral 1018 |
| Ral 2003 | Ral 3003 | Ral 3020 |
| Ral 5015 | Ral 5017 | Ral 5011 |
| Ral 6002 | Ral 6018 | Ral 6019 |
| Ral 7035 | Ral 7037 | Ral 7042 |
| Ral 7016 | Negro/Black/ Noir | |

VEE12 CA

**Colores fuera de carta /
Colors outside of letter /
Couleurs spéciales, hors palette**

| RAL | | NO RAL | |
|--|--------------------------------|---|--------------------------------|
| Epoxi | Líquida/ Liquid/ Liquide | Epoxi | Líquida/ Liquid/ Liquide |
| 817 € | 508 € | Consultar / Consulter / Consulter | |
| [x unidad/x unit/x unité] | | | |
| +10 días laborables / +10 work days / +10 jours ouvrés | | Consultar / Consulter / Consulter | |

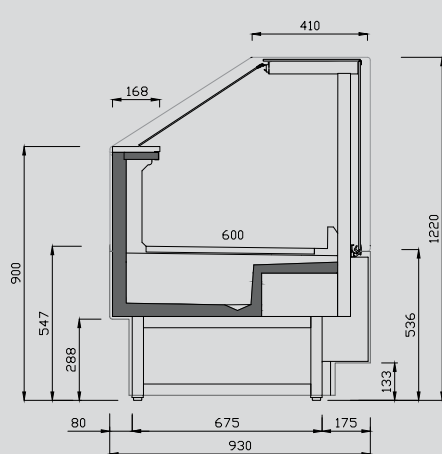



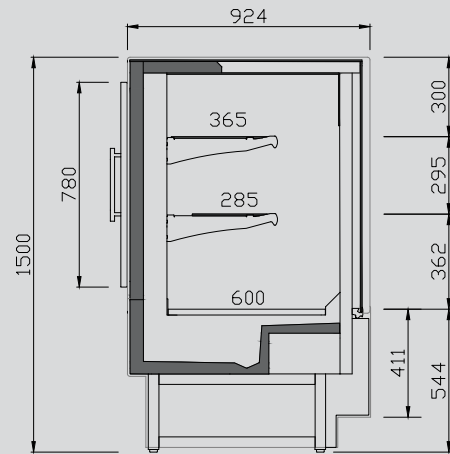

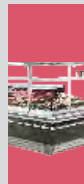

VEE



VEE CA



Vitrina Experience caliente / Experience hot display counter / Vitrine Experience chaude **(VEE HT)**
Vitr. Experience Gastronorm / Experience Gastronorm disp. count. / Vit. Experience Gastronorme **(VEE GC)**
Vitrina Experience estrecha / Experience narrow display counter / Vitrine Experience étroite **(VEES)**
Vitrina Experience neutra / Experience neutral display counter / Vitrine Experience neutre **(VEEN-VEEC)**

| MODELO MODELE MODÈLE |  VEE 12 HT |  VEE 12 GC |  VEE 12 S |  VEE 90 AAM |  VEE 06 C |  VEE 09 C |
|---|--|--|---|--|---|---|
| Precio Price Prix | 4.178 € | 4.113 € | 3.268 € | 1.530 € | 1.200 € | 1.220 € |
| Medidas / Measures / Mesures / (mm) | 1330 x 930 x 1220 mm. | 1330 x 930 x 1220 mm. | 1250 x 930 x 1220 mm. | 1330 x 930 x 907 mm. | 687 x 930 x 907 mm. | 1000 x 930 x 907 mm. |
| Temperatura Temperature Température (°C) | +65°C | | -1°C/+5°C | | - | |
| Clase Climática Climatic class Classe climatique (°C) | - | | 4 / 30°C | | - | |
| Tensión/Frecuencia Electrical data Tension électrique | 230V/1ph/50Hz | | | | | |
| Controlador Controller Régulateur | Digital | | | | | |
| Material Material Matériel (EXT/INT) | Ext: acero plastificado / Plastified stainless steel / Acier plastifié Encimera / Worktop / Dessous: Inox Aisi 304 Plano exposición / Exhibition plan / Plan d'exposition: Inox Aisi 304 | | | | | |
| Aislamiento Isolation Isolation (mm) | 40kg/m ³ / Free CFC's / Zero ODP-GWP | | | | | |
| Capacidad Capacity Capacité (L) | 225 | 90 | 135 | - | | |
| Superficie exposición Surface exhibition Surface d'exposition (m ²) | 0,75 | - | 0,89 | - | | |
| Compresor Compressor Compresseur (HP) | - | | | | | |
| Costados [2] Sides [2] Joues [2] (mm) | 30 + 30 | | | | | |
| Sistema de frío Cooling System Système de froid | Ventilado / Ventilated / Ventilé | | | | | |
| Desescarche Defrost Dégivrage | Automático / Automatic / Automatique | | | | | |
| Evaporación Evaporation Évaporation | Forzada / Forced / Ventilé | | | | | |
| Potencia Power Puissance (W) | 2250 | 2600 | - | - | | |
| Potencia frig. Cooling capacity Puissance Frig. (W A -10°C) | - | - | 1522 | - | | |
| Consumo Consumption Consommation (kWh/ 24h) | 21,6 | 24,9 | - | - | | |
| Refrigerante Refrigerant Gaz | R-290 | | | | - | |
| Opcional Optional Options | Puertas correderas / Sliding doors / Portes coulissantes VEE 12 S 105 € | | | | | |

Laterales no incluidos en el precio
Side panels not included in price
Joues non incluses dans le prix

Serie / Series / Série **VEE - CALIFORNIA**

+Info: www.infrico.com



VEE 12 HT



VEE 12 GC



VEE 12 S

Laterales / Sides / Jous

VEE HT / GC / AAM
Incluidos / Includes / Inclus

Laterales / Sides / Jous

| NO | |
|-----------------------------|----------------------------|
| Izquierdo Left Gauche | Derecho Right Droite |
| S: 374 € | S: 374 € |

VEE 90 AAMS



Ext. Estándar / Standar / Standard

| | | |
|------------------------|----------------------|----------|
| Blanco/White/ Blanc | Ral 1015 | Ral 1018 |
| Ral 2003 | Ral 3003 | Ral 3020 |
| Ral 5015 | Ral 5017 | Ral 5011 |
| Ral 6002 | Ral 6018 | Ral 6019 |
| Ral 7035 | Ral 7037 | Ral 7042 |
| Ral 7016 | Negro/Black/ Noir | |

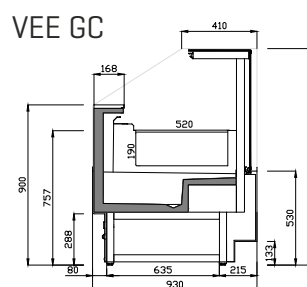
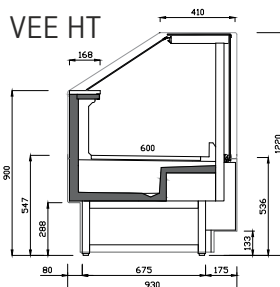

Colores fuera de carta / Colors outside of letter / Couleurs spéciales, hors palette



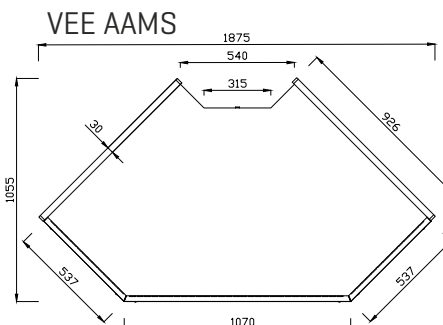
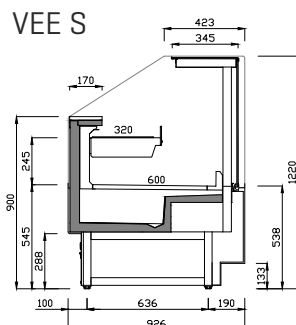



| RAL | | NO RAL | |
|--|--------------------------------|---|---|
| Epoxi | Líquida/ Liquid/ Liquide | Epoxi | Líquida/ Liquid/ Liquide |
| 817 € | 508 € | Consultar / Consultar / Consulter | Consultar / Consultar / Consulter |
| [x unidad/x unit/x unité] | | | |
| +10 días laborables / +10 work days / +10 jours ouvrés | | Consultar / Consultar / Consulter | |



Vitrina estrecha grupo incorporado / Narrow plug in refriger. display counter / Vitrine étroite groupe incorporé (VEE U)

Vitr. torre de carne grupo incorp. / Meat tower plug in display counter / Vitrine tour de viande groupe incorporé (VEE U CA)

Vitrina estrecha Take Away / Take Away narrow display counter / Vitrine étroite Take Away (VEE U S)

| MODELO MODELE MODÈLE |  VEE 12 U |  VEE 18 U |  VEE 25 U |  VEE 09 U CA |  VEE 12 U CA |  VEE 12 S U |
|---|--|---|---|--|--|---|
| Precio Price Prix | 3.098 € | 3.866 € | 4.585 € | 6.553 € | 7.008 € | 3.439 € |
| Medidas Measures Mesures [mm] | 1250 x 930 x 1220 mm. | 1875 x 930 x 1220 mm. | 2500 x 930 x 1220 mm. | 938 x 930 x 1500 mm. | 1250 x 930 x 1500 mm. | 1250 x 930 x 1220 mm. |
| Temperatura Temperature Température [°C] | -1°C/+5°C | | | | | |
| Clase Climática Climatic class Classe climatique [°C] | 4 / 30°C | | | | | |
| Tensión/Frecuencia Electrical data Tension électrique | 230V/1ph/50Hz | | | | | |
| Controlador Controller Régulateur | Digital | | | | | |
| Material Matériel [EXT/INT] | Ext: acero plastificado / Plastified stainless steel / Acier plastifié Encimera / Worktop / Dessous: Inox Aisi 304 Plano exposición / Exhibition plan / Plan d'exposition: Inox Aisi 304 | | | | | |
| Aislamiento Isolation Isolation [mm] | 40kg/m ³ / Free CFC's / Zero ODP-GWP | | | | | |
| Capacidad Capacity Capacité [L] | 150 | 225 | 300 | 190 | 253 | 150 |
| Superficie exposición Surface exhibition Surface d'exposition [m ²] | 0,75 | 1,13 | 1,50 | 1,08 | 1,44 | 0,89 |
| Compresor Compressor Compresseur [HP] | 1/3 | 3/4 | 1 | 3/4 | 1 | 1/3 |
| Costados [2] Sides [2] Joues [2] [mm] | 30 + 30 | | | | | |
| Sistema de frío Cooling System Système de froid | Ventilado / Ventilated / Ventilé | | | | | |
| Desescarche Defrost Dégivrage | Automático / Automatic / Automatique | | | Gas caliente / hot gas / Gaz chaud | | Automático / Automatic / Automatique |
| Evaporación Evaporation Évaporation | Forzada / Forced / Ventilé | | | | | |
| Potencia Power Puissance [W] | 374 | 541 | 642 | 784 | 893 | 374 |
| Potencia frig. Cooling capacity Puissance Frig. [W A -10°C] | - | | | | | |
| Consumo Consumption Consommation [kWh/ 24h] | 6,98 | 10,76 | 12,81 | 12,17 | 14,32 | 7,8 |
| Refrigerante Refrigerant Gaz | R-290 | | | | | |
| Opcional Optional Options | Puertas correderas / Sliding doors / Portes coulissantes VEE 12 105 € VEE 18 122 € VEE 25 163 € | | | - | | Puertas correderas / Sliding doors / Portes coulissantes 105 € |

Laterales no incluidos en el precio
Side panels not included in price
Joues non incluses dans le prix

Serie / Series / Série **VEE - CALIFORNIA**

+Info: www.infrico.com

VEE25 U



Laterales / Sides / Jouses

| NO | |
|-----------------------------|----------------------------|
| Izquierdo Left Gauche | Derecho Right Droite |
| U/SU: 374 € | U/SU: 374 € |
| VEE CA: 414 € | VEE CA: 414 € |



VEE12 U CA

Ext. Estándar / Standar / Standard

| | | |
|------------------------|----------------------|----------|
| Blanco/White/ Blanc | Ral 1015 | Ral 1018 |
| Ral 2003 | Ral 3003 | Ral 3020 |
| Ral 5015 | Ral 5017 | Ral 5011 |
| Ral 6002 | Ral 6018 | Ral 6019 |
| Ral 7035 | Ral 7037 | Ral 7042 |
| Ral 7016 | Negro/Black/ Noir | |

Colores fuera de carta /
Colors outside of letter /
Couleurs spéciales, hors palette

| RAL | | NO RAL | |
|--|--------------------------------|---|--------------------------------|
| Epoxi | Líquida/ Liquid/ Liquide | Epoxi | Líquida/ Liquid/ Liquide |
| 817 € | 508 € | Consultar / Consulter / Consulter | |
| [x unidad/x unit/x unité] | | | |
| +10 días laborables / +10 work days / +10 jours ouvrés | | Consultar / Consulter / Consulter | |

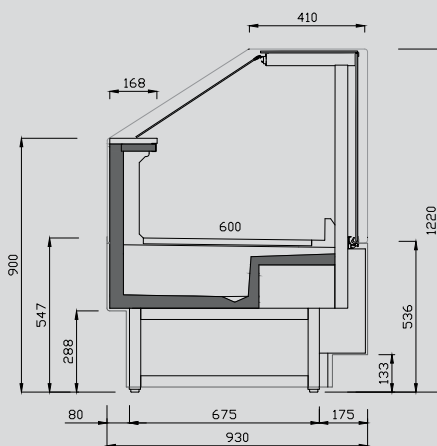

VEE U

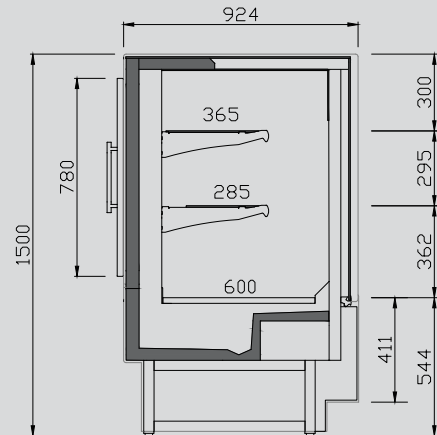

VEE U CA





Vitrina promocional grupo incorporado /
Promotional plug in counter /
Vitrine promotionnelle groupe incorporé

| MODELO MODELE MODÈLE | VVS | | SVS | | | | VCD | VVL | | |
|--|---|-----------------------------|-----------------------------|-----------------------------|------------------------------|------------------------------|--|-----------------------------|-----------------------------|--|
| | VVS 10 | VVS 12 | SVS 10 E1 | SVS 10 E2 | SVS 12 E1 | SVS 12 E2 | VCD 10 | VVL 10 | VVL 12 | |
| Precio Price Prix | 3.516 € | 3.679 € | 4.644 € | 4.856 € | 4.944 € | 5.160 € | 6.832 € | 3.593 € | 3.806 € | |
| Medidas Measures Mesures [mm] | 938 x 1000 x 950 mm. | 1250 x 1000 x 950 mm. | 938 x 1000 x 1200 mm. | 938 x 1000 x 1300 mm. | 1250 x 1000 x 1200 mm. | 1250 x 1000 x 1300 mm. | 1250 x 1250 x 950 mm. | 1106 x 1167 x 954 mm. | 1425 x 1167 x 954 mm. | |
| Temperatura Temperature Température [°C] | -1°C/+7°C | | | | | | -1°C/+1°C -22°C/-25°C | -1°C/+7°C | | |
| Clase Climática Climatic class Classe climatique [°C] | 4 / 30°C | | | | | | | | | |
| Tensión/Frecuencia Electrical data Tension électrique | 230V/1ph/50Hz | | | | | | | | | |
| Controlador Controller Régulateur | Digital | | | | | | | | | |
| Material Matériel [EXT/INT] | Acero epoxi / Epoxy steel / Acier epoxy | | | | | | | | | |
| Aislamiento Isolation Isolation [mm] | 40kg/m ³ / Free CFC's / Zero ODP-GWP | | | | | | 40kg/m ³ / Free CFC's / Zero ODP-GWP | | | |
| Capacidad Capacity Capacité [L] | 105 | 150 | 155 | 210 | 190 | 260 | 244 | 125 | 176 | |
| Superficie exposición Surface exhibition Surface d'exposition [m ²] | 0,64 | 0,85 | 0,97 | 1,20 | 1,30 | 1,60 | 1,06 | 0,85 | 1,14 | |
| Compresor Compressor Compresseur [HP] | 1/3 | 1/3 | 3/4 | 3/4 | 3/4 | 3/4 | 3/5 | 1/3 | 1/3 | |
| Costados [2] Sides [2] Joues [2] [mm] | - | | | | | | 42 | | | |
| Sistema de frío Cooling System Système de froid | Ventilado / Ventilated / Ventilé | | | | | | | | | |
| Desescarche Defrost Dégivrage | Automático / Automatic / Automatique | | | | | | | | | |
| Evaporación Evaporation Évaporation | Forzada / Forced / Ventilé | | | | | | | | | |
| Potencia Power Puissance [W] | 529 | 529 | 681 | 696 | 681 | 696 | 555 | 413 | 413 | |
| Potencia frig. Cooling capacity Puissance Frig. [W A -10°C] | - | | | | | | | | | |
| Consumo Consumption Consommation [kWh/ 24h] | 12,7 | 12,7 | 15,1 | 15,4 | 15,1 | 15,4 | 10,6 | 6,72 | 8,08 | |
| Refrigerante Refrigerant Gaz | R-290 | | | | | | | | | |
| Opcional Optional Options | | | | | | | Iluminación doble exposición 3000K / Double LED lighting 3000K color in exhibition area / Éclairage à double exposition 3000K | | 369 € | |
| | | | | | | | Tapa / Lid / Couvercle | | | |
| | | | | | | | - | | 307 € | |

Serie / Series / Série **VISION**

+Info: www.infrico.com

VVS 10



SVS 10E2



VCD 10

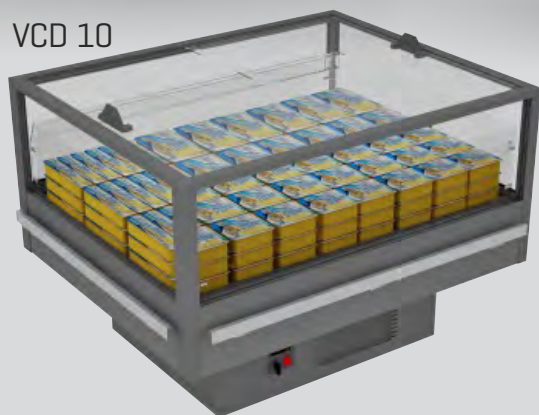

VWL 12



Laterales / Sides / Joutes

Incluidos / Includes / Inclus



Islas / Horizontal freezers / Îlots congélation



9



Isla de congelación cerrada estática /





Static closed horizontal freezer /

Îlot panoramique de congélation fermé statique

Armario combi superior para isla de congelación /

Top combi cabinet for horizontal freezer /

Armoire combi supérieure pour îlot de congélation

| MODELO MODELE MODÈLE |  GD21 PL1 |  GD25 PL1 |  GD C PL1 |  AS 25 UL1 |
|---|--|---|---|--|
| Precio Price Prix | 5.746 € | 6.157 € | 6.152 € | 8.386 € |
| Medidas Measures Mesures (mm) | 2100 x 980 x 1030 mm. | 2500 x 980 x 1220 mm. | 930 x 980 x 2100 mm. | 2500 x 750 x 2342 mm. |
| Temperatura Temperature Température (°C) | -15°C/-18°C | | | |
| Clase Climática Climatic class Classe climatique (°C) | 3 / 25°C | | | |
| Tensión/Frecuencia Electrical data Tension électrique | 230V/1ph/50Hz | | | |
| Controlador Controller Régulateur | Digital | | | |
| Material Material Matériel (EXT/INT) | Ext: acero plastificado / Plastified stainless steel / Acier plastifié Encimera / Worktop / Dessous: Inox Aisi 304 Plano exposición / Exhibition plan / Plan d'exposition: Inox Aisi 304 | | | |
| Aislamiento Isolation Isolation (mm) | 40kg/m ³ / Free CFC's / Zero ODP-GWP | | | |
| Capacidad Capacity Capacité (L) | 682 | 813 | 682 | 368 |
| Superficie exposición Surface exhibition Surface d'exposition (m ²) | 1,20 | 1,42 | 1,20 | 3,06 |
| Compresor Compressor Compresseur (HP) | 1 1/4 | 1 1/4 | 1 1/4 | 2/5 |
| Costados [2] Sides [2] Joues [2] (mm) | - | | | |
| Sistema de frío Cooling System Système de froid | Estático / Static / Estatique | | | Ventilado / Ventilated / Ventilé |
| Desescarche Defrost Dégivrage | Automático / Automatic / Automatique | | | Gas caliente/ Hot gas / Gaz chaud |
| Evaporación Evaporation Évaporation | Forzada / Forced / Ventilé | | | |
| Potencia Power Puissance (W) | 1803 | 2042 | 1803 | 1240 |
| Potencia frig. Cooling capacity Puissance Frig. (W A -10°C) | - | | | |
| Consumo Consumption Consommation (kWh/ 24h) | 12,1 | 14,5 | 12,1 | 24,0 |
| Refrigerante Refrigerant Gaz | R-290 | | | |
| Opcional Optional Options | Parrilla divisoria / Divider wire / Grille de séparation | | | 27 € |
| | Kit unión lateral / Lateral assembly kit / Kit union latérale | | | 82 € |
| | Kit unión zócalo / Base assembly kit / Kit union latérale | | | 18 € |
| | Kit unión cabecera / Header assembly kit / Kit union îlot de tête | | | 45 € |
| | Doble iluminación LED [encimera] / Double LED lighting [worktop] / Double éclairage LED [dessus] | Doble iluminación LED [encimera] / Double LED lighting [worktop] / Double éclairage LED [dessus] | | |
| | 91 € | 98 € | | |
| | Kit unión espalda / Back modules assembly kit / Kit union arrière | Kit unión espalda / Back modules assembly kit / Kit union arrière | | |
| | 62 € | 65 € | | |

Serie / Series / Série **GD**
 Serie / Series / Série **COMBI**

+Info: www.infrico.com

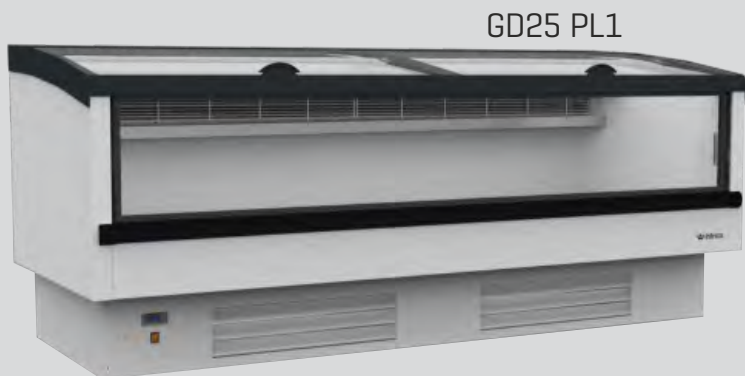

GD25 PL1

Laterales / Sides / Joes

Incluidos / Includes / Inclus

Decor. Interior / Exterior
 Interior Decor./ Exterior
 Décor. Intérieure / Extérieure

| | |
|---|--|
| Ral 9016 Blanco White Blanc | Ral 7016 Gris antracita Anthracite Gris anthracite |
|---|--|

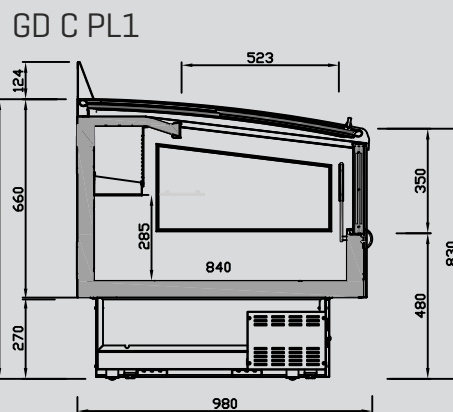
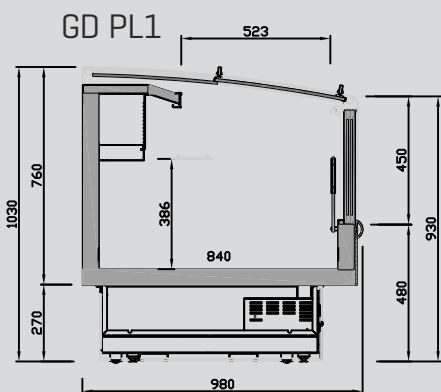

AS 25UL1

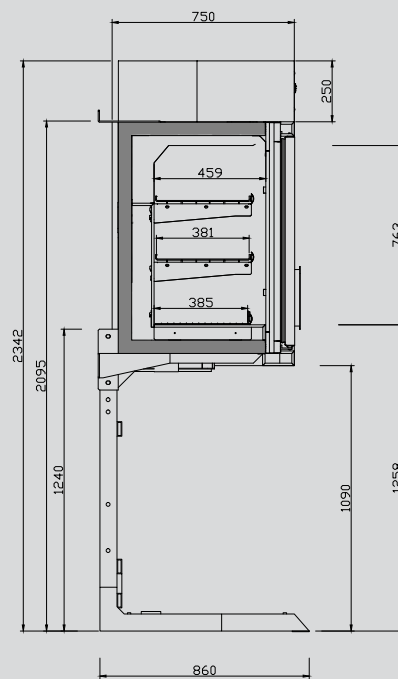

AS 25UL1

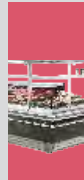

Murales

Multidecks / Murales





Serie / Series / Série

SMDG SMPB Edimburgo



SML DG
SML PB _____ 346-347

Serie / Series / Série

SMDCP Dublín



SMS DCP/DCPC
SML DCP/DCPC _____ 348-349

Serie / Series / Série

SMP Glasgow



SMS P/PC
SML P/PC _____ 350-351

Serie / Series / Série

VEG Elegance



VEG _____ 352-353

Serie / Series / Série

BIGGIE



VPG _____ 354-355

Serie / Series / Série

MDCP Rotterdam



MS DCP/DCPC
MN DCP/DCPC
ML DCP/DCPC
MS DCPI
MN DCPI
ML DCPI _____ 358-363

Serie / Series / Série

MP Munich



MS P/PC
MN P/PC
ML P/PC
MS PI
MN PI
ML PI _____ 364-369

Serie / Series / Série

MSBA Oporto MSDCBA Orleans



MS BA
MS DC BA _____ 370-371

Serie / Series / Série

MDR Rimini



MN DR
ML DR _____ 372-375

Serie / Series / Série

MDG Portland



MS DG
MN/MN22 DG
ML/ML22 DG
MX/MX22 DG 376-389

Serie / Series / Série

MDGU Detroit



MS DGU
MN DGU
ML/ML22 DGU 390-397

Serie / Series / Série

MPB Oslo



MN/MN22 PB
ML/ML22 PB
MX/MX22 PB 398-409

Serie / Series / Série

MBT Toronto



MN/MN22 BT
MF/MF22 BT 410-413

Serie / Series / Série

MBTU Montreal



MN BTU 414-415

Serie / Series / Série

MBTP Vancouver



MN BTP/BTPC 416-417

Serie / Series / Série

Opciones Options Options

418-419

Serie / Series / Série

Sigilus Intarbox Waterloop



Motocondensadoras
Condensing Units
Motocondensateurs 420-427

Serie / Series / Série

Intarcube



Centrales Frigoríficas
Refrigeration Units
Centrales Frigorifiques 428-429



10. Murales

Multidecks / Murales

Amplio rango dimensional para ofrecer la máxima capacidad.
Wide dimensional range for maximum capacity.
Une large gamme dimensionnelle pour offrir une capacité maximale.



6 625 **9** 938 **12** 1250 **18** 1875 **25** 2500 **31** 3125 **37** 3750

← Largo / Length / Longueur

S: 685 **N: 785** **L: 885** **F: 980** **X: 1085**

↙ Ancho / Width / Largeur



1075 **1500** **2000** **2200**

↑ Alto / Height / Hauteur

Máxima visibilidad de producto expuesto.
Maximum visibility of displayed product.
Visibilité maximale du produit exposé.



Iluminación / Lighting / Éclairage

Incorporación de iluminación LED, llegando a reducir el consumo energético entre un 80% y 90%, respecto a una bombilla tradicional. RGB opcional.

LED lighting incorporated, reducing energetic consumption between 80% and 90% respect to a traditional light bulb. RGB optional.

Éclairage LED, réduisant la consommation énergétique entre 80% et 90%, par rapport à une ampoule traditionnelle. RGB optionnel.



Rango completo de temperaturas.
Full temperature range.
Gamme de température complète.

T^a Prod. | T^a Aplic.

M0: -1/+4°C | -1/+1°C 🍷 🍹

M1: -1/+5°C | 0/+2°C 🍷 🍹 🍺 🍻

M2: -1/+7°C | +2/+4°C 🍷 🍹 🍺 🍻

H1: +1/+10°C | +4/+6°C 🍷 🍹

L1: -15/-18°C | -23/-25°C ❄️

+Info: www.infrico.com

Estantes regulables e inclinables optimizados para cada ancho, mejorando la capacidad de carga sin reposiciones.

Adjustable and tilting shelves optimised for each width, improving load capacity without repositioning.

Des étagères réglables et inclinables optimisées pour chaque largeur, améliorant la capacité de charge sans repositionnement.



Amplias posibilidades de personalización: amplia gama de colores, laterales, accesorios...

Extensive customisation possibilities: wide range of colours, sides, accessories...

Possibilités de personnalisation étendues : large gamme de couleurs, de côtés, d'accessoires...



Puertas / Doors / Portes

SLIM

Puerta estándar de gran aislamiento
Standard door highly efficient
Porte standard très isolée

Cristales dobles templados, carga de Argón 90%, integración total, bisagras oleodinámicas, cierre automático 0-85°.

Tempered double glass, Argon charge 90%, fully integrated, oleodynamic hinges, automatic closing 0-85°.

Double vitrage trempé, charge d'Argon 90%, intégration totale, charnières oléodynamiques, fermeture automatique 0-85°.

Puertas / Doors / Portes

TOTAL LOOK

Cristal doble completamente transparente
Fully transparent double glass door
Porte en verre double entièrement transparente

Cristales dobles templados, carga de Argón 90%, integración total, bisagras oleodinámicas, cierre automático 0-85°.

Tempered double glass, Argon charge 90%, fully integrated, oleodynamic hinges, automatic closing 0-85°.

Double vitrage trempé, charge d'Argon 90%, intégration totale, charnières oléodynamiques, fermeture automatique 0-85°.





10. Murales

Multidecks / Murales

Régimen de temperaturas / Temperature range / Régime de températures (ISO23953)

Tª Prod. | Tª Aplic.
M0: -1/+4°C | -1/+1°C

 Carne / Meat / Viande

 Pescado / Fish / Poisson

Tª Prod. | Tª Aplic.
M1: -1/+5°C | 0/+2°C

 Carne / Meat / Viande

 Pescado / Fish / Poisson

 4ª Gama / 4TH Range / 4ème Gamme

 Comida preparada / Grab & Go / Plats préparés

Tª Prod. | Tª Aplic.
M2: -1/+7°C | +2/+4°C

 Charcutería / Deli / Charcuterie

 Bebidas / Cold drinks / Boissons

 Lacteos / Dairy / Laitiers

Tª Prod. | Tª Aplic.
H1: +1/+10°C | +4/+6°C

 Lacteos / Dairy / Laitiers

 Frutas y verduras
Fruit vegetables

 Fruits et légumes

Tª Prod. | Tª Aplic.
L1: -15/-18°C | -23/-25°C

 Congelados

Frozen foods

Prod. Surgelés

Puertas / Doors / Portes

Total Look

Cristal doble completamente transparente

Fully transparent double glass door

Porte en verre double entièrement transparente



Cristales dobles templados, carga de Argón 90%, integración total, bisagras oleodinámicas, cierre automático 0-85°.

Tempered double glass, Argon charge 90%, fully integrated, oleodynamic hinges, automatic closing 0-85°.

Double vitrage trempé, charge d'Argon 90%, intégration totale, charnières oléodynamiques, fermeture automatique 0-85°.

Slim

Puerta estándar de gran aislamiento

Standard door highly efficient

Porte standard très isolée



Iluminación LED / LED lighting / Éclairage LED

Los sistemas de iluminación de Infrico te ayudan a dar la máxima visibilidad del producto manteniendo su frescura y conservación.

Infrico's lighting systems help you to give maximum product visibility while maintaining freshness and preservation.

Les systèmes d'éclairage d'Infrico vous permettent d'offrir une visibilité maximale du produit tout en maintenant la fraîcheur et la conservation.

24V, Led vertical IP65, Led visera IP54, plug and play, temp. de color de 3000-4000-6000K en función del producto.

24V, IP65 vertical LED, IP54 visor LED, plug and play, colour temperature 3000-4000-6000K depending on the product.

24V, LED verticale IP65, LED de visière IP54, plug and play, température de couleur 3000-4000-6000K selon le produit.



Waterin

Sistema Waterloop **R290** de Infrico

hasta
-25%

Sistema eficiente, hasta el 25% de ahorro de energía.
Efficient system with up to 25% energy saving.
Système efficace avec jusqu'à 25 % d'économies d'énergie.

-75%

75% reducción carga refrigerante.
75% refrigerant charge reduction.
Réduction de 75 % de la charge de réfrigérant.

0€

Refrigerantes naturales
SIN TASA.
Natural refrigerants WITHOUT CHARGE.
Réfrigérateurs naturels
SANS TÂCHE.



Mínima carga refrigerante, aprox. 0.1kg/kw.
Minimum refrigerant load, aprox. 0.1kg/kw.
Charge minimale de réfrigérant, avec environ 0,1 Kg/kw de réfrigération.



Flexibilidad de implantación.
Flexibility of implementation.
Flexibilité de mise en oeuvre.



Posibilidad de recuperación de calor en la instalación.
Possibility of heat recovery in the installation.
Possibilité de récupération de chaleur dans l'installation.



Condensadores sin mantenimiento.
Maintenance-free condensers.
Condensateurs de maintenance.



Posible eliminación de la sala de máquinas.
Possible elimination of the machine room.
Élimination possible, dans de nombreux cas, de la salle des machines.



Eliminación de riesgos típicos de inst. centralizadas.
Elimination of the typical risks of central installations.
Élimination des risques typiques des installations centralisées.



Menor riesgo de fugas.
Reduced risk of leakage.
Moins de risques de fuites.



El ahorro energético y el cuidado del medio ambiente son dos factores claves que han impulsado la iniciativa Waterin.

¿Qué es Waterin?

Waterin son muebles de refrigeración comercial para la conservación de productos refrigerados y congelados, con unidades individuales R290 y sistema de condensación por agua.

¿Dónde podemos instalar este sistema?

Este sistema es óptimo para instalaciones que cumplan los siguientes condicionantes:

- Sala de ventas de hasta 1400m² con aproximadamente hasta 40kW frigoríficos.
- Temperatura de trabajo exterior (DryCooler) máxima de 48°C.

¿Este nuevo sistema requiere un proyecto de instalación?

El sistema Waterin no requiere instalación frigorífica porque son muebles con la unidad ya instalada y cargada desde fábrica, aunque su implantación requiere un cálculo de instalación para el dimensionado de las tuberías de agua, el DryCooler, el sistema hidráulico necesarios y su ubicación, etc.

Beneficios del sistema Waterin

Waterin por ser un sistema ecológico y de condensación por agua ofrece múltiples beneficios en la refrigeración comercial. Mayor eficiencia energética, menor impacto ambiental y mejor control de temperatura son sólo algunas de sus ventajas.



Saving energy and respect for the environment are two key factors that have driven the Waterin initiative.

What's Waterin?

Waterin are commercial refrigeration display cases for the preservation of refrigerated and frozen products, with individual R290 units and water condensation system.

Where do we install this system?

This system is ideal for installations that meet the following conditions:

- Supermarkets up to 1400m² with approximately up to 40kW of refrigeration capacity.
- Outdoor working temperature (DryCooler) max. 48°C.

Is an installation project required?

The Waterin system doesn't require refrigeration installation because it's display cases with the unit already installed and loaded from the factory, although its implementation requires an installation calculation for the dimensioning of the water pipes, the DryCooler, the necessary hydraulic system and its location, etc.

Benefits of Waterin

Waterin is an environmentally friendly, water condensing system that offers multiple benefits in commercial refrigeration. Greater energy efficiency, lower environmental impact and better temperature control are just some of its advantages.



Les économies d'énergie et le respect de l'environnement sont deux facteurs qui ont motivé l'initiative Waterin.

Qu'est-ce que Waterin?

Waterin est une armoire de réfrigération commerciale pour les températures positives et négatives de stockage des produits, avec des unités R290 individuelles et un système de condensation à l'eau.

Où peut-on installer ce système?

Ce système est optimal pour les installations qui répondent aux conditions suivantes :

- Salle de vente jusqu'à 1400 m² avec environ jusqu'à 40kW d'unités de réfrigération
- Température extérieure de travail (DryCooler) maximale de 48°C.

Ce nouveau système nécessite-t-il un projet d'installation?

Le système Waterin ne nécessite pas d'installation frigorifique car il s'agit d'un meuble avec l'unité déjà installée et chargée en usine, bien que sa mise en œuvre dans la salle de vente nécessite un calcul de l'installation du système de condensation de l'eau et de ses composants.

Quels sont les avantages du système Waterin ?

Waterin est un système écologique à condensation par eau qui offre de multiples avantages dans le domaine de la réfrigération commerciale. Une meilleure efficacité énergétique, un impact environnemental réduit et un meilleur contrôle de la température ne sont que quelques-uns de ses avantages.



Waterin

Sistema Waterloop R290 de Infrico

Unidades R290 condensados por agua de Temperatura Positiva.
R290 units, Positive Temperature water condensed.
Unités R290 à condensation par eau à Température Positive.

Unidades R290 condensados por agua de Temperatura Negativa.
R290 units, Negative Temperature water condensed.
Unités R290 à condensation par eau à Température négative.



Posibilidad de recuperación de calor para calefacción o agua caliente sanitaria.

Possibility of heat recovery for heating or sanitary hot water.

Possibilité de récupération de chaleur pour le chauffage ou l'eau chaude sanitaire.

Unidades R290 condensados por agua de Temperatura Positiva.
R290 units, Positive Temperature water condensed.
Unités R290 à condensation par eau à Température Positive.



MDGW
MDGW22

MS(12-18-25-37) DGW M1-M2-H1
MN(12-18-25-37) DGW M1-M2-H1
ML(12-18-25-37) DGW M1-M2-H1
MN(12-18-25-37) DGW22 M1-M2-H1
ML(12-18-25-37) DGW22 M1-M2-H1



MBTW

MN(2P-3P) BTW L1
MN(2P-3P) BTW22 L1

Dry Coolers con grupo hidráulico.
 Dry Coolers with hydraulic power unit.
 Dry Coolers avec unité hydraulique.

Unidades R290 condensados por agua de Temperatura Negativa.
 R290 units, Negative Temperature water condensed.
 Unités R290 à condensation par eau à Température négative.

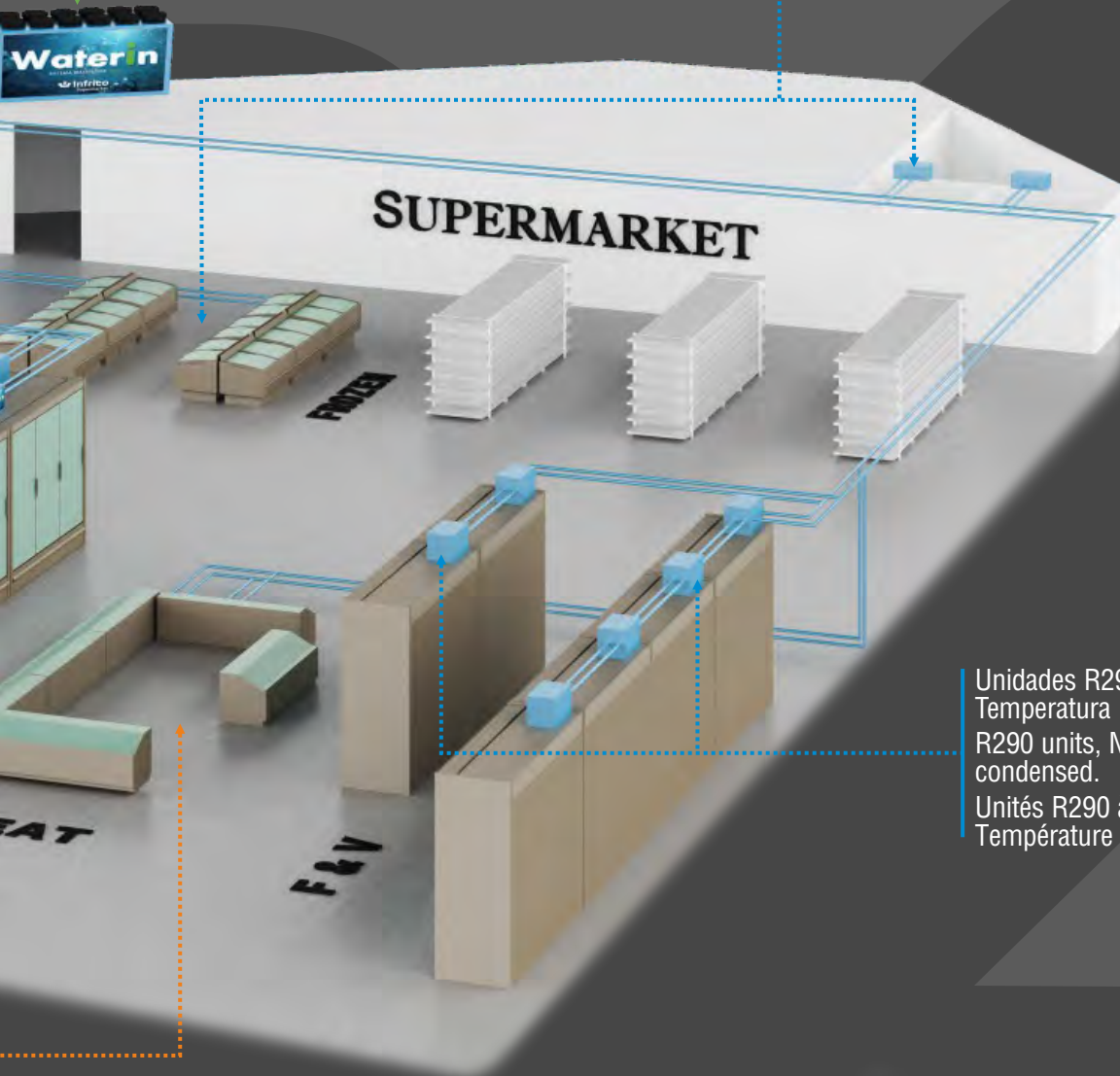

Unidades R290 condensados por agua de Temperatura Negativa.
 R290 units, Negative Temperature water condensed.
 Unités R290 à condensation par eau à Température négative.



**SEMIMURALES /
LOW MULTIDECK DISPLAY CASES /
VITRINES SEMI MURALES**



Aceites y Salsas
Arroces
Cafés y Solubles



Semimural abierta y cerrada refrigerada grupo remoto

Open and close refrigeration low multideck remote group

Semi murale de réfrigération ouverte et fermée groupe à distance



| | SMDG | | | | SMPB | | | | | | | | | | | | | | | | | | | | | |
|---|--|-----------------------------|-----------------------------|-----------------------------|-----------------------------|-----------------------------|-----------------------------|-----------------------------|------------------------|----------------------|----------|----------|----------|----------|----------|----------|----------|----------|----------|----------|----------|----------|----------|----------|----------|----------------------|
| MODELO MODELE MODÈLE | SML12 DG M1 | SML18 DG M1 | SML25 DG M1 | SML37 DG M1 | SML12 PB M1 | SML18 PB M1 | SML25 PB M1 | SML37 PB M1 | | | | | | | | | | | | | | | | | | |
| Precio Price Prix | M1 | 4.367 € | 5.691 € | 7.286 € | 10.198 € | 3.041 € | 3.865 € | 4.412 € | 5.572 € | | | | | | | | | | | | | | | | | |
| MOD. | SML12 DG M2 | SML18 DG M2 | SML25 DG M2 | SML37 DG M2 | SML12 PB M2 | SML18 PB M2 | SML25 PB M2 | SML37 PB M2 | | | | | | | | | | | | | | | | | | |
| Precio Price Prix | M2 | 4.570 € | 5.691 € | 7.286 € | 10.198 € | 3.037 € | 3.865 € | 4.412 € | 5.572 € | | | | | | | | | | | | | | | | | |
| Medidas / Mesures / Mesures / [mm] Sin costados / Without sides / Sans joues | 1250 x 904 x 1500 mm. | 1875 x 904 x 1500 mm. | 2500 x 904 x 1500 mm. | 3750 x 904 x 1500 mm. | 1250 x 904 x 1500 mm. | 1875 x 904 x 1500 mm. | 2500 x 904 x 1500 mm. | 3750 x 904 x 1500 mm. | | | | | | | | | | | | | | | | | | |
| T°. Prod. Aplic. Prod. T°. Applic. T°. (°C) Temp. Prod. Temp. Appliq. | M1: -1/+5°C 0/+2°C M2: -1/+7°C +2/+4°C | | | | | | | | | | | | | | | | | | | | | | | | | |
| Clase Climática Climatic class (°C) Classe climatique | 3 / 25°C | | | | | | | | | | | | | | | | | | | | | | | | | |
| Tensión/Frecuencia Electrical data Tension électrique | 230V/1ph/50Hz | | | | | | | | | | | | | | | | | | | | | | | | | |
| Controlador Controller Régulateur | Digital | | | | | | | | | | | | | | | | | | | | | | | | | |
| Material Material Matériel [EXT/INT] | Acero galvanizado plastificado / Plastified galvanised steel / Acier galvanisé plastifié | | | | | | | | | | | | | | | | | | | | | | | | | |
| Aislamiento Isolation Isolation [mm] | 40kg/m ³ / Free CFC's / Zero ODP-GWP | | | | | | | | | | | | | | | | | | | | | | | | | |
| Capacidad Capacity Capacité [L] | 486 | 729 | 973 | 1459 | 486 | 729 | 973 | 1459 | | | | | | | | | | | | | | | | | | |
| Superficie exposición Surface exhibition [x m ²] Surface d'exposition | 1,17 | 1,76 | 2,34 | 3,52 | 1,49 | 2,23 | 2,97 | 4,46 | | | | | | | | | | | | | | | | | | |
| Niveles Exposición Exposition Levels Niveaux d'exposition | 3+Expos. | | | | | | | | | | | | | | | | | | | | | | | | | |
| Costados [2] Sides [2] Joues [2] [mm] | 40 + 40 | | | | | | | | | | | | | | | | | | | | | | | | | |
| Sistema de frío Cooling System Système de froid | Ventilado / Ventilated / Ventilé | | | | | | | | | | | | | | | | | | | | | | | | | |
| Desescarche Defrost Dégivrage | Automático / Automatic / Automatique | | | | | | | | | | | | | | | | | | | | | | | | | |
| Evaporación Evaporation Évaporation | Forzada / Forced / Ventilé | | | | | | | | | | | | | | | | | | | | | | | | | |
| Potencia Power Puissance [W] | M1 80,5 M2 80,5 | M1 121 M2 121 | M1 161 M2 161 | M1 242 M2 242 | M1 80,5 M2 80,5 | M1 121 M2 121 | M1 161 M2 161 | M1 242 M2 242 | | | | | | | | | | | | | | | | | | |
| Potencia frig. Cooling capacity Puissance Frig. [W A -10°C] | M1 446 M2 338 | M1 669 M2 581 | M1 1339 M2 1163 | M1 2121 M2 1803 | M1 3188 M2 2704 | M1 4243 M2 3605 | M1 6364 M2 5408 | M1 5438 M2 4624 | | | | | | | | | | | | | | | | | | |
| Consumo Consumption Consommation [kWh/ 24h] | M1 1,35 M2 1,35 | M1 2,03 M2 2,03 | M1 2,70 M2 2,70 | M1 4,06 M2 4,06 | M1 1,35 M2 1,35 | M1 2,03 M2 2,03 | M1 2,70 M2 2,70 | M1 4,06 M2 4,06 | | | | | | | | | | | | | | | | | | |
| Refrigerante Refrigerant Gaz | FREON | | | | | | | | | | | | | | | | | | | | | | | | | |
| Laterales / Sides / Joues | No Incluidos / Not includes / Non inclus | | | | | | | | | | | | | | | | | | | | | | | | | |
| Colores estándar Standard colors Couleurs standard | Int. Estándar / Standar / Standard <table border="1"> <tr> <td>Blanco/White/ Blanc</td> <td>Negro/Black/ Noir</td> <td>Ral 7016</td> </tr> </table> | | | | | | | | Blanco/White/ Blanc | Negro/Black/ Noir | Ral 7016 | | | | | | | | | | | | | | | |
| Blanco/White/ Blanc | Negro/Black/ Noir | Ral 7016 | | | | | | | | | | | | | | | | | | | | | | | | |
| Laterales disponibles Available sides Joues disponibles | Ext. Estándar / Standar / Standard <table border="1"> <tr> <td>Blanco/White/ Blanc</td> <td>Ral 1015</td> <td>Ral 1018</td> </tr> <tr> <td>Ral 2003</td> <td>Ral 3003</td> <td>Ral 3020</td> </tr> <tr> <td>Ral 5015</td> <td>Ral 5017</td> <td>Ral 5011</td> </tr> <tr> <td>Ral 6002</td> <td>Ral 6018</td> <td>Ral 6019</td> </tr> <tr> <td>Ral 7035</td> <td>Ral 7037</td> <td>Ral 7042</td> </tr> <tr> <td>Ral 7016</td> <td>Ral 9006</td> <td>Negro/Black/ Noir</td> </tr> </table> | | | | | | | | Blanco/White/ Blanc | Ral 1015 | Ral 1018 | Ral 2003 | Ral 3003 | Ral 3020 | Ral 5015 | Ral 5017 | Ral 5011 | Ral 6002 | Ral 6018 | Ral 6019 | Ral 7035 | Ral 7037 | Ral 7042 | Ral 7016 | Ral 9006 | Negro/Black/ Noir |
| Blanco/White/ Blanc | Ral 1015 | Ral 1018 | | | | | | | | | | | | | | | | | | | | | | | | |
| Ral 2003 | Ral 3003 | Ral 3020 | | | | | | | | | | | | | | | | | | | | | | | | |
| Ral 5015 | Ral 5017 | Ral 5011 | | | | | | | | | | | | | | | | | | | | | | | | |
| Ral 6002 | Ral 6018 | Ral 6019 | | | | | | | | | | | | | | | | | | | | | | | | |
| Ral 7035 | Ral 7037 | Ral 7042 | | | | | | | | | | | | | | | | | | | | | | | | |
| Ral 7016 | Ral 9006 | Negro/Black/ Noir | | | | | | | | | | | | | | | | | | | | | | | | |
| Opciones pág. 426-427 Options pages 426-427 Options pages 426-427 |  <p>Lateral Espejo Mirror end panels Joue Miroir</p> <p>Lateral Panorámico Panoramic end panels Joue panoramique</p> <p>Lateral Display Display end panels Joue Display</p> | | | | | | | | | | | | | | | | | | | | | | | | | |

Serie / Series / Série **SMDG (EDIMBURGO)**
 Serie / Series / Série **SMPB (EDIMBURGO)**

+Info: www.infrico.com

SML25DG



SML25PB

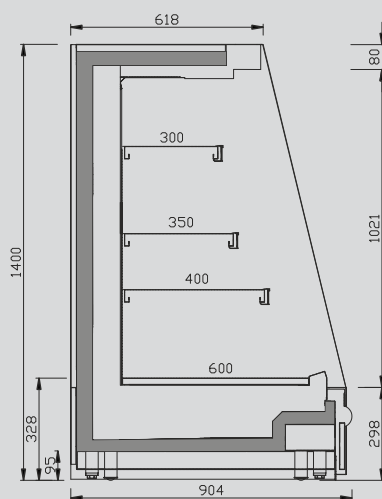

SML PB

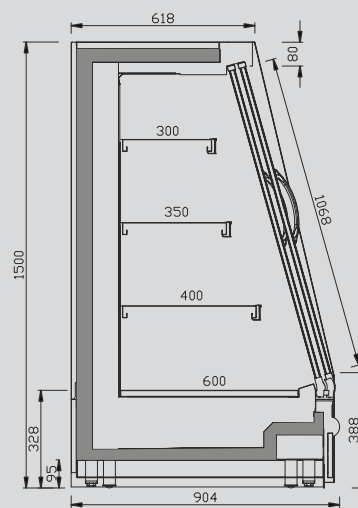

SML DG



Semimural plug in de refrigeración cerradas

Plug in refrigeration doors low multideck

Semi murale de réfrigération fermée groupe incorporé



| MODELO MODELE MODÈLE | | | | | | | |
|--|----------------------|--|----------------------------------|----------------------------------|---|----------------------------------|----------------------------------|
| Precio Price Prix | M1 | 4.205 € | 5.404 € | 7.197 € | 4.398 € | 5.609 € | 7.300 € |
| MOD. | SMS12 DCPC M1 | SMS18 DCPC M1 | SMS25 DCPC M1 | SML12 DCPC M1 | SML18 DCPC M1 | SML25 DCPC M1 | |
| Precio Price Prix | C M1 | 4.289 € | 5.513 € | 7.341 € | 4.487 € | 5.721 € | 7.446 € |
| MOD. | SMS12 DCP M2 | SMS18 DCP M2 | SMS25 DCP M2 | SML12 DCP M2 | SML18 DCP M2 | SML25 DCP M2 | |
| Precio Price Prix | M2 | 4.205 € | 5.404 € | 7.049 € | 4.398 € | 5.609 € | 7.300 € |
| MOD. | SMS12 DCPC M2 | SMS18 DCPC M2 | SMS25 DCPC M2 | SML12 DCPC M2 | SML18 DCPC M2 | SML25 DCPC M2 | |
| Precio Price Prix | C M2 | 4.289 € | 5.513 € | 7.189 € | 4.487 € | 5.721 € | 7.446 € |
| Medidas / Measures / Mesures / [mm] Sin costados / Without sides / Sans joues | | 1250 x 685 x 1500 mm. | 1875 x 685 x 1500 mm. | 2500 x 685 x 1500 mm. | 1250 x 885 x 1500 mm. | 1875 x 885 x 1500 mm. | 2500 x 885 x 1500 mm. |
| T°. Prod. Aplic. Prod. T°. Applic. T°. (°C) Temp. Prod. Temp. Appliq. | | M1: -1/+5°C 0/+2°C M2: -1/+7°C +2/+4°C | | | | | |
| Clase Climática Climatic class Classe climatique | | 3 / 25°C | | | | | |
| Tensión/Frecuencia Electrical data Tension électrique | | 230V/1ph/50Hz | | | | | |
| Controlador Controller Régulateur | | Digital | | | | | |
| Material Material Matériel | (EXT/INT) | Acero galvanizado plastificado / Plastified galvanised steel / Acier galvanisé plastifié | | | | | |
| Aislamiento Isolation Isolation | [mm] | 40kg/m ³ / Free CFC's / Zero ODP-GWP | | | | | |
| Capacidad Capacity Capacité | [L] | 263 | 396 | 528 | 345 | 518 | 690 |
| Superficie exposición Surface exhibition Surface d'exposition | [x m ²] | 1,14 | 1,72 | 2,08 | 1,20 | 2,10 | 2,80 |
| Niveles Exposición Exposition Levels Niveaux d'exposition | | 3+Expos. | | | | | |
| Costados [2] Sides [2] Joues [2] | [mm] | 40 + 40 | | | | | |
| Puertas Doors Portes | | 2 | | 4 | | 2 | 4 |
| Sistema de frío Cooling System Système de froid | | Ventilado / Ventilated / Ventilé | | | | | |
| Desescarche Defrost Dégivrage | | Automático / Automatic / Automatique | | | | | |
| Evaporación Evaporation Évaporation | | Forzada / Forced / Ventilé | | | | | |
| Potencia Power Puissance | [W] | M1 537 M2 537 | M1 725 M2 725 | M1 1116 M2 1116 | M1 537 M2 537 | M1 700 M2 700 | M1 1116 M2 1116 |
| Potencia frig. Cooling capacity Puissance Frig. | [W A -10°C] | - | | | | | |
| Consumo Consumption Consommation | [kWh/ 24h] | M1 8,18 M2 7,87 | M1 10,7 M2 10,3 | M1 15,1 M2 14,1 | M1 8,93 M2 7,87 | M1 11,0 M2 10,3 | M1 15,8 M2 15,3 |
| Refrigerante Refrigerant Gaz | | R-290 | | | | | |
| Colores estándar Standard colors Couleurs standard | | Ext. Estándar / Standar / Standard | | | Laterales / Sides / Joues | | |
| | | Blanco/White/ Blanc | Ral 1015 | Ral 1018 | No Incluidos / Not includes / Non inclus | | |
| | | Ral 2003 | Ral 3003 | Ral 3020 | | | |
| Laterales disponibles Available sides Joues disponibles | | Ral 5015 | Ral 5017 | Ral 5011 | Int. Estándar / Standar / Standard | | |
| | | Ral 6002 | Ral 6018 | Ral 6019 | Blanco/White/ Blanc | Negro/Black/ Noir | Ral 7016 |
| | | Ral 7035 | Ral 7037 | Ral 7042 | | | |
| Opciones pág. 426-427 Options pages 426-427 Options pages 426-427 | | Ral 7016 | Ral 9006 | Negro/Black/ Noir | | | |
| | | | | | | | |

Serie / Series / Série **SMDCP (DUBLÍN)**

+Info: www.infrico.com

SML25DCP

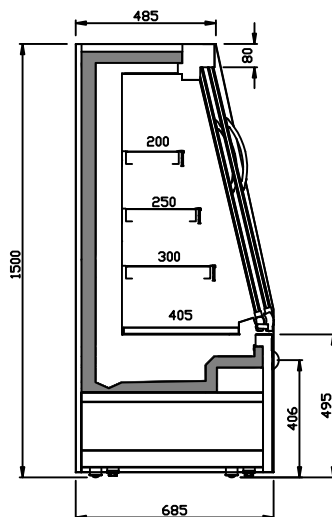
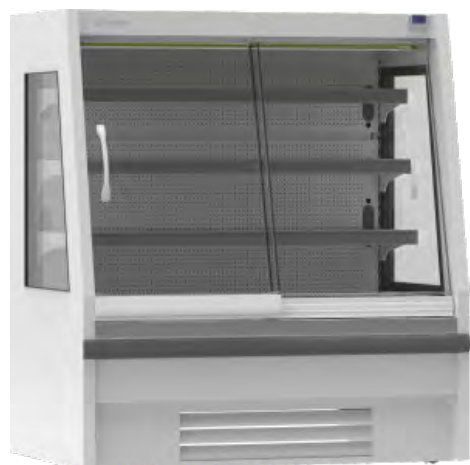

SMS DCP

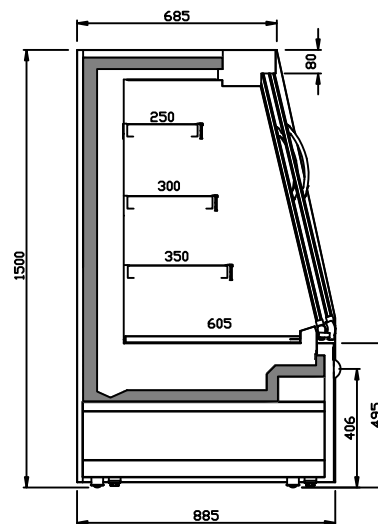

SML DCP

SMS12DCP



Semimural plug in de refrigeración abiertas

Plug in refrigeration open low multideck

Semi murale de réfrigération ouverte groupe incorporé



| MODELO MODEL MODÈLE | | | | | | | | | | | | | | | | | | | | | | | | | | | | | | | | |
|---|---|---|--|-----------------------------|-----------------------------|-----------------------------|----------------------------|----------------------------|-----------------------------|-----------------------------|-----------------------------|---|---|--|--|----------|----------|------------------------|----------------------|----------|--|----------|----------|----------|----------|----------|----------|----------|----------|----------|----------|----------------------|
| Precio Price Prix | M2 | 2.116€ | 2.561€ | 2.801€ | 3.669€ | 4.941€ | 2.201€ | 2.603€ | 2.912€ | 3.693€ | 4.988€ | | | | | | | | | | | | | | | | | | | | | |
| MOD. | SMS6 PC M2 | SMS9 PC M2 | SMS12 PC M2 | SMS18 PC M2 | SMS25 PC M2 | SML6 PC M2 | SML9 PC M2 | SML12 PC M2 | SML18 PC M2 | SML25 PC M2 | | | | | | | | | | | | | | | | | | | | | | |
| Precio Price Prix | C M2 | 2.158€ | 2.612€ | 2.857€ | 3.742€ | 5.040€ | 2.245€ | 2.655€ | 2.969€ | 3.766€ | 5.087€ | | | | | | | | | | | | | | | | | | | | | |
| Medidas / Mesures / Mesures / [mm] Sin costados / Without sides / Sans joues | | 625 x 685 x 1500 mm. | 938 x 685 x 1500 mm. | 1250 x 685 x 1500 mm. | 1875 x 685 x 1500 mm. | 2500 x 685 x 1500 mm. | 625 x 885 x 1500 mm. | 938 x 885 x 1500 mm. | 1250 x 885 x 1500 mm. | 1875 x 885 x 1500 mm. | 2500 x 885 x 1500 mm. | | | | | | | | | | | | | | | | | | | | | |
| T°. Prod. Aplic. Prod. T°. Applic. T°. (°C) Temp. Prod. Temp. Appliq. | | M2: -1/+7°C +2/+4°C | | | | | | | | | | | | | | | | | | | | | | | | | | | | | | |
| Clase Climática Climatic class (°C) Classe climatique | | 3 / 25°C | | | | | | | | | | | | | | | | | | | | | | | | | | | | | | |
| Tensión/Frecuencia Electrical data Tension électrique | | 230V/1ph/50Hz | | | | | | | | | | | | | | | | | | | | | | | | | | | | | | |
| Controlador Controller Régulateur | | Digital | | | | | | | | | | | | | | | | | | | | | | | | | | | | | | |
| Material Material Matériel [EXT/INT] | | Acero galvanizado plastificado / Plastified galvanised steel / Acier galvanisé plastifié | | | | | | | | | | | | | | | | | | | | | | | | | | | | | | |
| Aislamiento Isolation Isolation [mm] | | 40kg/m ³ / Free CFC's / Zero ODP-GWP | | | | | | | | | | | | | | | | | | | | | | | | | | | | | | |
| Capacidad Capacity Capacité [L] | | 63 | 95 | 127 | 190 | 253 | 179 | 269 | 358 | 537 | 716 | | | | | | | | | | | | | | | | | | | | | |
| Superficie exposición Surface exhibition Surface d'exposition [x m ²] | | 0,82 | 1,22 | 1,63 | 2,45 | 3,26 | 0,94 | 1,41 | 1,88 | 2,82 | 3,76 | | | | | | | | | | | | | | | | | | | | | |
| Niveles Exposición Exposition Levels Niveaux d'exposition | | 3+Expos. | | | | | | | | | | | | | | | | | | | | | | | | | | | | | | |
| Costados [2] Sides [2] Joues [2] [mm] | | 40 + 40 | | | | | | | | | | | | | | | | | | | | | | | | | | | | | | |
| Puertas Doors Portes | | - | | | | | | | | | | | | | | | | | | | | | | | | | | | | | | |
| Sistema de frío Cooling System Système de froid | | Ventilado / Ventilated / Ventilé | | | | | | | | | | | | | | | | | | | | | | | | | | | | | | |
| Desescarche Defrost Dégivrage | | Automático / Automatic / Automatique | | | | | | | | | | | | | | | | | | | | | | | | | | | | | | |
| Evaporación Evaporation Évaporation | | Forzada / Forced / Ventilé | | | | | | | | | | | | | | | | | | | | | | | | | | | | | | |
| Potencia Power Puissance [W] | | 461 | 599 | 609 | 1031 | 1331 | 461 | 599 | 609 | 1031 | 1331 | | | | | | | | | | | | | | | | | | | | | |
| Potencia frig. Cooling capacity Puissance Frig. [W A -10°C] | | - | | | | | | | | | | | | | | | | | | | | | | | | | | | | | | |
| Consumo Consumption Consommation [kWh/ 24h] | | 7,2 | 9,6 | 9,8 | 10,1 | 18,5 | 7,6 | 11,2 | 11,8 | 16,3 | 19,0 | | | | | | | | | | | | | | | | | | | | | |
| Refrigerante Refrigerant Gaz | | R-290 | | | | | | | | | | | | | | | | | | | | | | | | | | | | | | |
| Colores estándar Standar colors Couleurs standard | | <table border="0"> <tr> <td colspan="3">Int. Estándar / Standar / Standard</td> <td colspan="3">Laterales / Sides / Joues</td> </tr> <tr> <td>Blanco/White/ Blanc</td> <td>Negro/Black/ Noir</td> <td>Ral 7016</td> <td colspan="3" style="text-align: center;">No Incluidos / Not includes / Non inclus</td> </tr> </table> | | | | | | | | | | Int. Estándar / Standar / Standard | | | Laterales / Sides / Joues | | | Blanco/White/ Blanc | Negro/Black/ Noir | Ral 7016 | No Incluidos / Not includes / Non inclus | | | | | | | | | | | |
| Int. Estándar / Standar / Standard | | | Laterales / Sides / Joues | | | | | | | | | | | | | | | | | | | | | | | | | | | | | |
| Blanco/White/ Blanc | Negro/Black/ Noir | Ral 7016 | No Incluidos / Not includes / Non inclus | | | | | | | | | | | | | | | | | | | | | | | | | | | | | |
| Laterales disponibles Available sides Joues disponibles | | <table border="0"> <tr> <td colspan="3">Ext. Estándar / Standar / Standard</td> </tr> <tr> <td>Blanco/White/ Blanc</td> <td>Ral 1015</td> <td>Ral 1018</td> </tr> <tr> <td>Ral 2003</td> <td>Ral 3003</td> <td>Ral 3020</td> </tr> <tr> <td>Ral 5015</td> <td>Ral 5017</td> <td>Ral 5011</td> </tr> <tr> <td>Ral 6002</td> <td>Ral 6018</td> <td>Ral 6019</td> </tr> <tr> <td>Ral 7035</td> <td>Ral 7037</td> <td>Ral 7042</td> </tr> <tr> <td>Ral 7016</td> <td>Ral 9006</td> <td>Negro/Black/ Noir</td> </tr> </table> | | | | | | | | | | Ext. Estándar / Standar / Standard | | | Blanco/White/ Blanc | Ral 1015 | Ral 1018 | Ral 2003 | Ral 3003 | Ral 3020 | Ral 5015 | Ral 5017 | Ral 5011 | Ral 6002 | Ral 6018 | Ral 6019 | Ral 7035 | Ral 7037 | Ral 7042 | Ral 7016 | Ral 9006 | Negro/Black/ Noir |
| Ext. Estándar / Standar / Standard | | | | | | | | | | | | | | | | | | | | | | | | | | | | | | | | |
| Blanco/White/ Blanc | Ral 1015 | Ral 1018 | | | | | | | | | | | | | | | | | | | | | | | | | | | | | | |
| Ral 2003 | Ral 3003 | Ral 3020 | | | | | | | | | | | | | | | | | | | | | | | | | | | | | | |
| Ral 5015 | Ral 5017 | Ral 5011 | | | | | | | | | | | | | | | | | | | | | | | | | | | | | | |
| Ral 6002 | Ral 6018 | Ral 6019 | | | | | | | | | | | | | | | | | | | | | | | | | | | | | | |
| Ral 7035 | Ral 7037 | Ral 7042 | | | | | | | | | | | | | | | | | | | | | | | | | | | | | | |
| Ral 7016 | Ral 9006 | Negro/Black/ Noir | | | | | | | | | | | | | | | | | | | | | | | | | | | | | | |
| Opciones pág. 426-427 Options pages 426-427 Options pages 426-427 | | <table border="0"> <tr> <td></td> <td>Lateral Espejo Mirror end panels Joue Miroir</td> <td></td> <td>Lateral Display Display end panels Joue Display</td> </tr> </table> | | | | | | | | | | | Lateral Espejo Mirror end panels Joue Miroir | | Lateral Display Display end panels Joue Display | | | | | | | | | | | | | | | | | |
| | Lateral Espejo Mirror end panels Joue Miroir | | Lateral Display Display end panels Joue Display | | | | | | | | | | | | | | | | | | | | | | | | | | | | | |

Serie / Series / Série **SMP (GLASGOW)**

+Info: www.infrico.com

SMS18P C



**Nuevo
paragolpes
frontal**

**New
front
bumper**

**Nouveau
pare-chocs
frontale**



SML18P

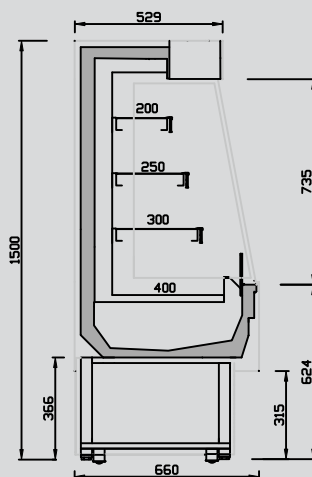

SMS P

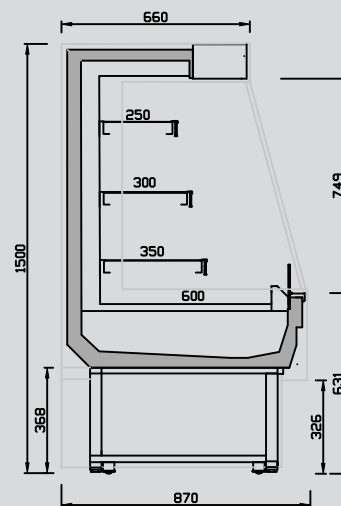

SML P



Semimural plug in R-290 de refrigeración abierta, estética vitrina

Closed plug in refrigeration low multideck, aesthetically display case

Semi murale de réfrigération R-290 groupe incorporé, esthétique vitrine

| MODELO MODELE MODÈLE | | | | |
|---|---|------------------------------|--|------------------------------|
| | VEG9U | VEG12U | VEG15U | VEG18U |
| Precio Price Prix | U 3.656 € | 4.089 € | 4.670 € | 5.117 € |
| MOD. | VEG9IU | VEG12IU | VEG15IU | VEG18IU |
| Precio Price Prix | IU 3.794 € | 4.283 € | 4.914 € | 5.380 € |
| Medidas Measures (mm) Mesures | 938 x 1075 x 1260 mm. | 1250 x 1075 x 1260 mm. | 1562 x 1075 x 1260 mm. | 1875 x 1075 x 1260 mm. |
| T°. Prod. Aplic. Prod. T°. Applic. T°. (°C) Temp. Prod. Temp. Appliq. | M2: -1/+7°C +2/+4°C | | | |
| Clase Climática Climatic class Classe climatique (°C) | 3 / 25°C | | | |
| Tensión/Frecuencia Electrical data Tension électrique | 230V/1ph/50Hz | | | |
| Controlador Controller Régulateur | Digital | | | |
| Material Material Matériel (EXT/INT) | Ext/Int: Acero galvanizado plastificado / Plastified galvanised steel / Acier galvanisé plastifié Int: Inox AISI 304 (mod. I) | | | |
| Aislamiento Isolation Isolation (mm) | 40kg/m ³ / Free CFC's / Zero ODP-GWP | | | |
| Capacidad Capacity Capacité (L) | 316 | 425 | 531 | 638 |
| Superficie exposición Surface exhibition (x m ²) Surface d'exposition | 0,83 | 1,12 | 1,39 | 1,67 |
| Compresor Compressor Compresseur (HP) | 3/4 | 3/4 | 1 | 1+1/4 |
| Estantes Shelving Étagères | - | | | |
| Costados (2) Sides (2) Joues (2) (mm) | 30+30 | | | |
| Sistema de frío Cooling System Système de froid | Ventilado / Ventilated / Ventilé | | | |
| Desescarche Defrost Dégivrage | Automático / Automatic / Automatique | | | |
| Evaporación Evaporation Évaporation | Forzada / Forced / Ventilé | | | |
| Potencia Power Puissance (W) | 595 | 741 | 838 | 1229 |
| Potencia frig. Cooling capacity Puissance Frig. (W A -10°C) | - | | | |
| Consumo Consumption Consommation (kWh/ 24h) | 7,85 | 9,8 | 11,1 | 14,8 |
| Refrigerante Refrigerant Gaz | R-290 | | | |
| Colores estándar Standar colors Couleurs standard | Int. Estándar / Standar / Standard Blanco/White/Blanc Negro/Black/Noir | | Laterales / Sides / Joues No Incluidos / Not includes / Non inclus | |
| Laterales disponibles Available sides Joues disponibles | Ext. Estándar / Standar / Standard Blanco/White/Blanc Ral 1001 Ral 1018 Ral 2003 Ral 3003 Ral 3020 Design 2108025 Ral 5015 Ral 4007 Ral 6002 Design 1107060 Design 3504035 Ral 9006 Ral 7016 Ral 8017 | | | |
| Opciones pág. 426-427 Options pages 426-427 Options pages 426-427 | | | | |

Serie / Series / Série **VEG (ELEGANCE)**

+Info: www.infrico.com

VEG18



VEG15

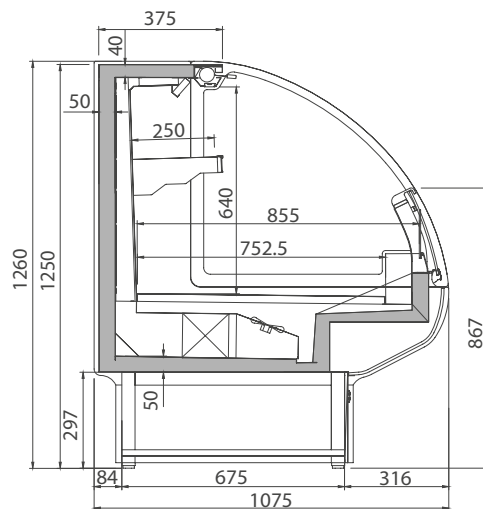

VEG



Isla promocional autoservicio

Self-service promotional island

Îlot promotionnel en libre-service



VPG37

| MODELO MODELE MODÈLE | |
|---|--|
| Precio Price Prix | 25.990 € |
| Medidas Measures [mm] Mesures | 3600 x 1895 x 1735 mm. |
| T°. Prod. Aplic. Prod. T°. Applic. T°. [°C] Temp. Prod. Temp. Appliq. | M2: -1/+7°C |
| Clase Climática Climatic class Classe climatique [°C] | 3 / 25°C |
| Tensión/Frecuencia Electrical data Tension électrique | 230V/1ph/50Hz |
| Controlador Controller Régulateur | Digital |
| Material Material [EXT/INT] Matériel | EXT: Acero negro y madera de roble natural / Black stainless and natural oak wood / Acier noir et bois de chêne naturel INT: Acero negro / Black stainless / Acier noir |
| Aislamiento Isolation [mm] Isolation | 40kg/m ³ / Free CFC's / Zero ODP-GWP |
| Capacidad Capacity [L] Capacité | 1026 |
| Superficie exposición Surface exhibition [x m ²] Surface d'exposition | 7,98 |
| Compresor Compressor [HP] Compresseur | 1 + 1 + 1 1/2 + 1 1/2 |
| Niveles Exposición Exposition Levels Niveaux d'exposition | 3 |
| Costados [2] Sides [2] [mm] Joues [2] | 40+40 |
| Sistema de frío Cooling System Système de froid | Ventilado / Ventilated / Ventilé |
| Desescarche Defrost Dégivrage | Automático / Automatic / Automatique |
| Evaporación Evaporation Évaporation | Forzada / Forced / Ventilé |
| Potencia Power [W] Puissance | 2x746 + 2x1112 |
| Potencia frig. Cooling capacity [W A -10°C] Puissance Frig. | - |
| Consumo Consumption [kWh/ 24h] Consommation | 2x5,21 + 2x7,53 |
| Refrigerante Refrigerant Gaz | R-290 |
| Colores estándar Standar colors Couleurs standard | |
| Laterales disponibles Available sides Joues disponibles | - |
| Opciones pág. 426-427 Options pages 426-427 Options pages 426-427 | |

Serie / Series / Série **VPG (BIGGIE)**

+Info: www.infrico.com

VPG37 (2xVGG18UCB + 2xMGG18PM2)

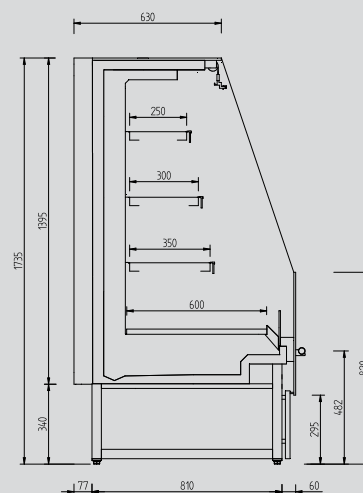
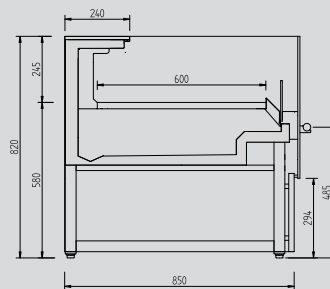

MURALES /
VERTICAL MULTIDECK DISPLAY CASES /
MURALES





Mural plug in de refrigeración cerrada

Plug in refrigeration doors multidecks

Murale de réfrigération fermée groupe incorporé



| MODELO Price Price MODÈLE | MS6 DCP M1 / DCPC M1 | MS9 DCP M1 / DCPC M1 | MS12 DCP M1 / DCPC M1 | MS18 DCP M1 / DCPC M1 | MS25 DCP M1 / DCPC M1 | | |
|--|-----------------------------|--|-------------------------------|----------------------------------|--|---|--|
| Precio Price Prix | M1 / C M1 | 3.399 / 3.479 € | 3.838 / 3.927 € | 3.893 / 3.984 € | 5.161 / 5.276 € | 6.270 / 6.407 € | |
| MOD. | MS6 DCP M2 / DCPC M2 | MS9 DCP M2 / DCPC M2 | MS12 DCP M2 / DCPC M2 | MS18 DCP M2 / DCPC M2 | MS25 DCP M2 / DCPC M2 | MS25 DCP M2 / DCPC M2 | |
| Precio Price Prix | M2 / C M2 | 3.399 / 3.479 € | 3.838 / 3.927 € | 3.893 / 3.984 € | 5.161 / 5.276 € | 6.270 / 6.407 € | |
| MOD. | - | MS9 DCP H1 / DCPC H1 | MS12 DCP H1 / DCPC H1 | MS18 DCP H1 / DCPC H1 | MS25 DCP H1 / DCPC H1 | MS25 DCP H1 / DCPC H1 | |
| Precio Price Prix | H1 / C H1 | - | 3.882 / 3.972 € | 3.939 / 4.030 € | 5.219 / 5.335 € | 6.338 / 6.476 € | |
| MOD. | - | MS9 DCPI M1 / DCPI M2 | MS12 DCPI M1 / DCPI M2 | MS18 DCPI M1 / DCPI M2 | - | - | |
| Precio Price Prix | INOX M1 / M2 | - | 4.380 / 4.380€ | 4.867 / 4.867 € | 6.609 / 6.609 € | - | |
| Medidas Measures (mm) Mesures | | 625 x 685 x 2000 mm. | 938 x 685 x 2000 mm. | 1250 x 685 x 2000 mm. | 1875 x 685 x 2000 mm. | 2500 x 685 x 2000 mm. | |
| Tª. Prod. Aplic. Prod. Tª. Applic. Tª. (°C) Temp. Prod. Temp. Appliq. | | M1: -1/+5°C 0/+2°C | | M2: -1/+7°C +2/+4°C | H1: +1/+10°C +4/+6°C | | |
| Clase Climática Climatic class (°C) Classe climatique | | 3 / 25°C | | | | | |
| Tensión/Frecuencia Electrical data Tension électrique | | 230V/1ph/50Hz | | | | | |
| Controlador Controller Régulateur | | Digital | | | | | |
| Material Material [EXT/INT] Matériel | | Acero galvanizado plastificado / Plastified galvanised steel / Acier galvanisé plastifié | | | | | |
| Aislamiento Isolation (mm) Isolation | | 40kg/m³ / Free CFC's / Zero ODP-GWP | | | | | |
| Capacidad Capacity (L) Capacité | | M1, M2: 230 H1: 184 | M1, M2: 341 H1: 278 | M1, M2: 455 H1: 370 | M1, M2: 683 H1: 555 | M1, M2: 910 H1: 740 | |
| Superficie exposición Surface exhibition (x m²) Surface d'exposition | | M1, M2: 0,80 H1: 0,80 | M1, M2: 1,11 H1: 1,11 | M1, M2: 1,45 H1: 1,45 | M1, M2: 2,17 H1: 2,17 | M1, M2: 2,90 H1: 2,90 | |
| Niveles Exposición Exposition Levels Niveaux d'exposition | | M1-M2: 4+Expos. H1: 3+Expos. | | | | | |
| Costados [2] Sides [2] (mm) Joues [2] | | 40 + 40 | | | | | |
| Puertas Doors Portes | | 1 | 2 | 2 | 3 | 4 | |
| Sistema de frío Cooling System Système de froid | | Ventilado / Ventilated / Ventilé | | | | | |
| Desescarche Defrost Dégivrage | | Automático / Automatic / Automatique | | | | | |
| Evaporación Evaporation Evaporation | | Forzada / Forced / Ventilé | | | | | |
| Potencia Power (W) Puissance | | M1: 539 M2: 539 H1: 539 | M1: 626 M2: 672 H1: 672 | M1: 714 M2: 770 H1: 770 | M1: 837 M2: 899 H1: 899 | M1: 2164 M2: 2374 H1: 2374 | |
| Potencia frig. Cooling capacity (W A -10°C) Puissance Frig. | | - | | | | | |
| Consumo Consumption (kWh/24h) Consommation | | M1: 7,86 M2: 6,88 H1: 5,99 | M1: 8,89 M2: 7,97 H1: 7,27 | M1: 9,88 M2: 8,79 H1: 8,62 | M1: 12,81 M2: 11,14 H1: 10,74 | M1: 17,10 M2: 15,64 H1: 14,08 | |
| Refrigerante Refrigerant Gaz | | R-290 | | | | | |
| Colores estándar Standar colors Couleurs standard | | Ext. Estándar / Standar / Standard | | Laterales / Sides / Joues | | | |
| | | Blanco/White/ Blanc | Ral 1015 | Ral 1018 | No incluidos / Not includes / Non inclus | | |
| | | Ral 2003 | Ral 3003 | Ral 3020 | | | |
| Laterales disponibles Available sides Joues disponibles | | Ral 5015 | Ral 5017 | Ral 5011 | Int. Estándar / Standar / Standard | | |
| | | Ral 6002 | Ral 6018 | Ral 6019 | Blanco/White/ Blanc | | |
| | | Ral 7035 | Ral 7037 | Ral 7042 | Negro/Black/ Noir | | |
| | | Ral 7016 | Ral 9006 | Negro/Black/ Noir | Ral 7016 | | |
| Opciones pág. 426-427 Options pages 426-427 Options pages 426-427 | | | | | | | |
| | | | | | | | |
| | | | | | Lateral Espejo Mirror end panels Joue Miroir | Lateral Display Display end panels Joue Display | |

Serie / Series / Série **MDCP (ROTTERDAM)**

+Info: www.infrico.com

MS25 DCPC M2



MS18 DCPI M1

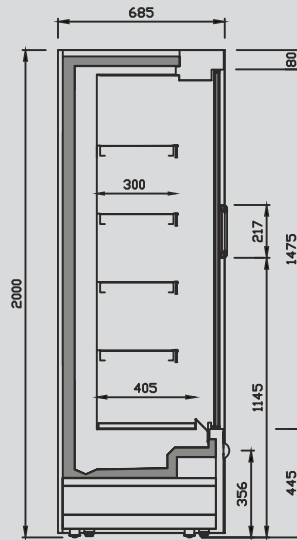

MS DCP M1/M2

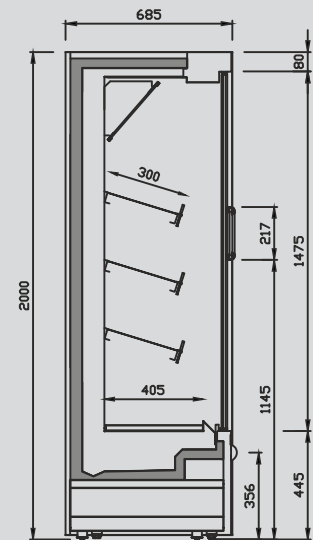

MS DCP H1



Los datos técnicos están sujetos a posibles variaciones que se actualizarán periódicamente en las fichas técnicas de producto que están disponibles en la web / The technical data are subject to possible variations, that will be updated periodically in the technical data sheets of the product which are available on the website / Les données techniques peuvent varier et seront actualisées dans les fiches techniques de produit disponibles sur le site internet

Mural plug in de refrigeración cerrada

Plug in refrigeration doors multidecks

Murale de réfrigération fermée groupe incorporé

N: 785

| MODELO MODELE MODÈLE | | | | | |
|---|------------------------------|--|----------------------------------|---|-------------------------------------|
| Precio Price Prix | M1 / C M1 | 3.908 / 3.998 € | 3.965 / 4.056 € | 5.257 / 5.375 € | 6.388 / 6.529 € |
| MOD. | MN9 DCP M2 / DCPC M2 | MN12 DCP M2 / DCPC M2 | MN18 DCP M2 / DCPC M2 | MN25 DCP M2 / DCPC M2 | |
| Precio Price Prix | M2 / C M2 | 3.908 / 3.998 € | 3.965 / 4.056 € | 5.257 / 5.375 € | 6.388 / 6.529 € |
| MOD. | MN9 DCP H1 / DCPC H1 | MN12 DCP H1 / DCPC H1 | MN18 DCP H1 / DCPC H1 | MN25 DCP H1 / DCPC H1 | |
| Precio Price Prix | H1 / C H1 | 3.953 / 4.045 € | 4.011 / 4.103 € | 5.316 / 5.435 € | 6.458 / 6.599 € |
| MOD. | MN9 DCPI M1 / DCPI M2 | MN12 DCPI M1 / DCPI M2 | MN18 DCPI M1 / DCPI M2 | - | |
| Precio Price Prix | INOX M1 / M2 | 4.369 / 4.369 € | 4.866 / 4.866 € | 6.642 / 6.642 € | - |
| Medidas Measures Mesures | (mm) | 938 x 785 x 2000 mm. | 1250 x 785 x 2000 mm. | 1875 x 785 x 2000 mm. | 2500 x 785 x 2000 mm. |
| Tª. Prod. Aplic. Prod. Tª. Applic. Tª. (°C) Temp. Prod. Temp. Appliq. | | M1: -1/+5°C 0/+2°C M2: -1/+7°C +2/+4°C H1: +1/+10°C +4/+6°C | | | |
| Clase Climática Climatic class Classe climatique | (°C) | 3 / 25°C | | | |
| Tensión/Frecuencia Electrical data Tension électrique | | 230V/1ph/50Hz | | | |
| Controlador Controller Régulateur | | Digital | | | |
| Material Matériel | [EXT/INT] | Acero galvanizado plastificado / Plastified galvanised steel / Acier galvanisé plastifié | | | |
| Aislamiento Isolation Isolation | (mm) | 40kg/m³ / Free CFC's / Zero ODP-GWP | | | |
| Capacidad Capacity Capacité | (L) | M1, M2: 394 H1: 319 | M1, M2: 526 H1: 426 | M1, M2: 789 H1: 639 | M1, M2: 1053 H1: 852 |
| Superficie exposición Surface exhibition Surface d'exposition | (x m²) | M1, M2: 1,97 H1: 1,60 | M1, M2: 2,63 H1: 2,10 | M1, M2: 3,95 H1: 3,20 | M1, M2: 5,30 H1: 4,20 |
| Niveles Exposición Exposition Levels Niveaux d'exposition | | M1-M2: 4+Expos. H1: 3+Expos. | | | |
| Costados [2] Sides [2] Joues [2] | (mm) | 40 + 40 | | | |
| Puertas Doors Portes | | 2 | 2 | 3 | 4 |
| Sistema de frío Cooling System Système de froid | | Ventilado / Ventilated / Ventilé | | | |
| Desescarche Defrost Dégivrage | | Automático / Automatic / Automatique | | | |
| Evaporación Evaporation Evaporation | | Forzada / Forced / Ventilé | | | |
| Potencia Power Puissance | (W) | M1: 626 M2: 672 H1: 672 | M1: 714 M2: 770 H1: 770 | M1: 837 M2: 899 H1: 899 | M1: 1192 M2: 1297 H1: 1297 |
| Potencia frig. Cooling capacity Puissance Frig. | (W A -10°C) | - | | | |
| Consumo Consumption Consommation | (kWh/ 24h) | M1: 8.09 M2: 7.54 H1: 6.07 | M1: 8.99 M2: 8.38 H1: 7.10 | M1: 15.59 M2: 9.53 H1: 8.57 | M1: 16.56 M2: 14.91 H1: 13.41 |
| Refrigerante Refrigerant Gaz | | R-290 | | | |
| Colores estándar Standard colors Couleurs standard | | Ext. Estándar / Standar / Standard | | Laterales / Sides / Joues | |
| | | Blanco/White/ Blanc | Ral 1015 Ral 1018 | No incluidos / Not includes / Non inclus | |
| | | Ral 2003 | Ral 3003 Ral 3020 | | |
| Laterales disponibles Available sides Joues disponibles | | Ral 5015 | Ral 5017 Ral 5011 | Int. Estándar / Standar / Standard | |
| | | Ral 6002 | Ral 6018 Ral 6019 | Blanco/White/ Blanc | |
| | | Ral 7035 | Ral 7037 Ral 7042 | Negro/Black/ Noir | |
| | | Ral 7016 | Ral 9006 Negro/Black/ Noir | Ral 7016 | |
| Opciones pág. 426-427 Options pages 426-427 Options pages 426-427 | | | | | |

Serie / Series / Série **MDCP (ROTTERDAM)**

+Info: www.infrico.com

MN25 DCPC M2



**Nuevo
paragolpes
frontal**

**New
front
bumper**

**Nouveau
pare-chocs
frontale**



MN25 DCP H1

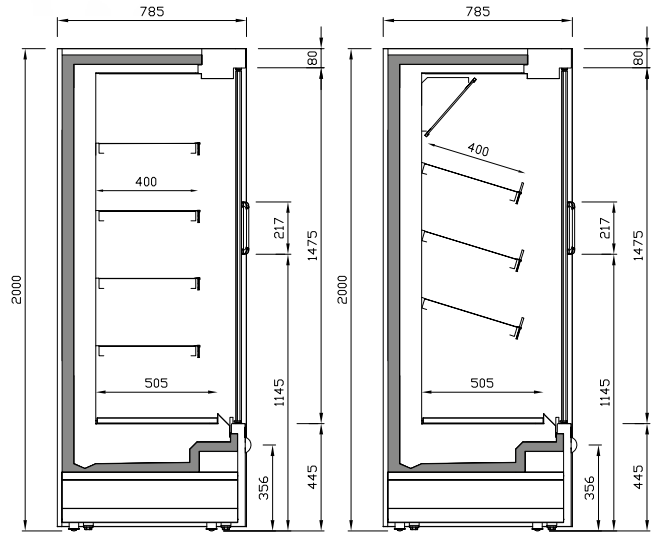

MN DCP M1/M2

MN DCP H1



están sujetos a cambios de precio y disponibilidad de los productos, disponibles en la web /
 are subject to price changes and availability of the products, available on the website.
 Les prix et la disponibilité des produits sont susceptibles de varier et sont disponibles sur le site web.



Selección de productos
 para reducir el ruido
 en la puerta.
GRACIAS

Mural plug in de refrigeración cerrada

Plug in refrigeration doors multidecks

Murale de réfrigération fermée groupe incorporé



| MODELO MODELE MODÈLE | | | | | |
|---|------------------------------|--|----------------------------------|---|-------------------------------------|
| Precio Price Prix | M1 / C M1 | 3.973 / 4.066 € | 4.031 / 4.124 € | 5.350 / 5.469 € | 6.503 / 6.645 € |
| MOD. | ML9 DCP M2 / DCPC M2 | ML12 DCP M2 / DCPC M2 | ML18 DCP M2 / DCPC M2 | ML25 DCP M2 / DCPC M2 | |
| Precio Price Prix | M2 / C M2 | 3.973 / 4.066 € | 4.031 / 4.124 € | 5.350 / 5.469 € | 6.503 / 6.645 € |
| MOD. | M19 DCP H1 / DCPC H1 | ML12 DCP H1 / DCPC H1 | ML18 DCP H1 / DCPC H1 | ML25 DCP H1 / DCPC H1 | |
| Precio Price Prix | H1 / C H1 | 4.019 / 4.113 € | 4.078 / 4.173 € | 50410 / 5.530 € | 6.574 / 6.719 € |
| MOD. | ML9 DCPI M1 / DCPI M2 | ML12 DCPI M1 / DCPI M2 | ML18 DCPI M1 / DCPI M2 | - | |
| Precio Price Prix | INOX M1 / M2 | 4.358 / 4.358 € | 4.865 / 4.865 € | 6.676 / 6.676 € | - |
| Medidas Measures Mesures | (mm) | 938 x 885 x 2000 mm. | 1250 x 885 x 2000 mm. | 1875 x 885 x 2000 mm. | 2500 x 885 x 2000 mm. |
| Tª. Prod. Aplic. Prod. Tª. Applic. Tª. (°C) Temp. Prod. Temp. Appliq. | | M1: -1/+5°C 0/+2°C M2: -1/+7°C +2/+4°C H1: +1/+10°C +4/+6°C | | | |
| Clase Climática Climatic class Classe climatique | (°C) | 3 / 25°C | | | |
| Tensión/Frecuencia Electrical data Tension électrique | | 230V/1ph/50Hz | | | |
| Controlador Controller Régulateur | | Digital | | | |
| Material Matériel | [EXT/INT] | Acero galvanizado plastificado / Plastified galvanised steel / Acier galvanisé plastifié | | | |
| Aislamiento Isolation Isolation | (mm) | 40kg/m³ / Free CFC's / Zero ODP-GWP | | | |
| Capacidad Capacity Capacité | (L) | M1, M2: 414 H1: 339 | M1, M2: 551 H1: 451 | M1, M2: 827 H1: 677 | M1, M2: 1103 H1: 903 |
| Superficie exposición Surface exhibition Surface d'exposition | (x m²) | M1, M2: 2,07 H1: 1,70 | M1, M2: 2,80 H1: 2,30 | M1, M2: 4,10 H1: 3,40 | M1, M2: 5,50 H1: 4,50 |
| Niveles Exposición Exposition Levels Niveaux d'exposition | | M1-M2: 4+Expos. H1: 3+Expos. | | | |
| Costados [2] Sides [2] Joues [2] | (mm) | 40 + 40 | | | |
| Puertas Doors Portes | | 2 | 2 | 3 | 4 |
| Sistema de frío Cooling System Système de froid | | Ventilado / Ventilated / Ventilé | | | |
| Desescarche Defrost Dégivrage | | Automático / Automatic / Automatique | | | |
| Evaporación Evaporation Evaporation | | Forzada / Forced / Ventilé | | | |
| Potencia Power Puissance | (W) | M1: 627 M2: 672 H1: 673 | M1: 714 M2: 770 H1: 770 | M1: 837 M2: 899 H1: 899 | M1: 1192 M2: 1297 H1: 1297 |
| Potencia frig. Cooling capacity Puissance Frig. | (W A -10°C) | - | | | |
| Consumo Consumption Consommation | (kWh/ 24h) | M1: 8.09 M2: 7.54 H1: 6.07 | M1: 9.34 M2: 8.38 H1: 7.10 | M1: 10.59 M2: 9.53 H1: 8.57 | M1: 16.56 M2: 14.91 H1: 13.41 |
| Refrigerante Refrigerant Gaz | | R-290 | | | |
| Colores estándar Standard colors Couleurs standard | | Ext. Estándar / Standar / Standard | | Laterales / Sides / Joues | |
| | | Blanco/White/ Blanc | Ral 1015 Ral 1018 | No incluidos / Not includes / Non inclus | |
| | | Ral 2003 | Ral 3003 Ral 3020 | | |
| Laterales disponibles Available sides Joues disponibles | | Ral 5015 | Ral 5017 Ral 5011 | Int. Estándar / Standar / Standard | |
| | | Ral 6002 | Ral 6018 Ral 6019 | Blanco/White/ Blanc | |
| | | Ral 7035 | Ral 7037 Ral 7042 | Negro/Black/ Noir | |
| | | Ral 7016 | Ral 9006 Negro/Black/ Noir | Ral 7016 | |
| Opciones pág. 426-427 Options pages 426-427 Options pages 426-427 | | | | | |

Serie / Series / Série **MDCP (ROTTERDAM)**

+Info: www.infrico.com

ML25 DCPC M2



**Nuevo
paragolpes
frontal**

**New
front
bumper**

**Nouveau
pare-chocs
frontale**



ML25 DCP H1

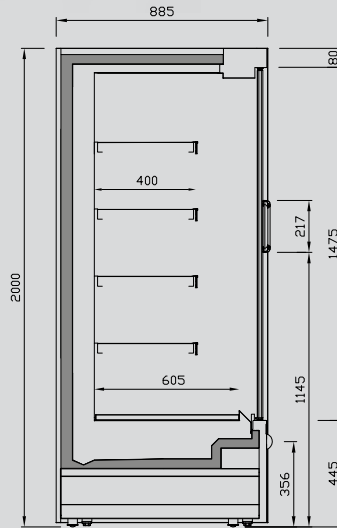

ML DCP M1/M2

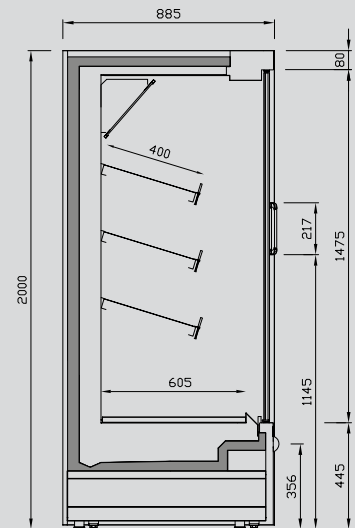

ML DCP H1



Para reducir
nuestro huella
medioambiental

Selección
de productos
verdes de origen
local.

GRACIAS

363

Las especificaciones técnicas de los productos pueden variar sin previo aviso. Se recomienda consultar el catálogo de productos actualizado periódicamente en www.infrico.com.
The technical specifications of the products may vary without prior notice. It is recommended to consult the product catalogue updated periodically on www.infrico.com.
Les caractéristiques techniques des produits peuvent varier sans préavis. Il est recommandé de consulter le catalogue de produits actualisé périodiquement sur www.infrico.com.

Mural plug in de refrigeración abierta frente bajo

Plug in refrigeration open low front multidecks

Murale de réfrigération ouverte groupe incorporé avec frontal bas



| MODELO MODELE MODÈLE | | | | | | |
|---|-------------------------|--|-----------------------------|-------------------------------|---|-------------------------------|
| Precio Price Prix | M1 / C M1 | 2.610 / 2.674 € | 3.141 / 3.215 € | 3.565 / 3.648 € | 5.291 / 5.409 € | 5.658 / 5.783 € |
| MOD. | MS6 P M2 / PC M2 | MS9 P M2 / PC M2 | MS12 P M2 / PC M2 | MS18 P M2 / PC M2 | MS25 P M2 / PC M2 | |
| Precio Price Prix | M2 / C M2 | 2.610 / 2.674 € | 3.141 / 3.215 € | 3.565 / 3.648 € | 5.291 / 5.409 € | 5.658 / 5.783 € |
| MOD. | MS6 P H1 / PC H1 | MS9 P H1 / PC H1 | MS12 P H1 / PC H1 | MS18 P H1 / PC H1 | MS25 P H1 / PC H1 | |
| Precio Price Prix | H1 / C H1 | 2.643 / 2.708 € | 3.178 / 3.254 € | 3.607 / 3.691 € | 5.350 / 5.468 € | 5.721 / 5.849 € |
| MOD. | - | MS9 PI M1 / PI M2 | MS12 PI M1 / PI M2 | MS18 PI M1 / PI M2 | - | |
| Precio Price Prix | INOX M1 / M2 | - | 3.575 / 3.575 € | 4.059 / 4.059 € | 6.050 / 6.050 € | - |
| Medidas Measures Mesures | (mm) | 625 x 685 x 2000 mm. | 938 x 685 x 2000 mm. | 1250 x 685 x 2000 mm. | 1875 x 685 x 2000 mm. | 2500 x 685 x 2000 mm. |
| Tª. Prod. Aplic. Prod. Tª. Applic. Tª. (°C) Temp. Prod. Temp. Appliq. | | M1: -1/+5°C 0/+2°C | | M2: -1/+7°C +2/+4°C | H1: +1/+10°C +4/+6°C | |
| Clase Climática Climatic class Classe climatique | (°C) | 3 / 25°C | | | | |
| Tensión/Frecuencia Electrical data Tension électrique | | 230V/1ph/50Hz | | | | |
| Controlador Controller Régulateur | | Digital | | | | |
| Material Material Matériel | [EXT/INT] | Acero galvanizado plastificado / Plastified galvanised steel / Acier galvanisé plastifié | | | | |
| Aislamiento Isolation Isolation | (mm) | 40kg/m³ / Free CFC's / Zero ODP-GWP | | | | |
| Capacidad Capacity Capacité | (L) | M1, M2: 213 H1: 176 | M1, M2: 320 H1: 264 | M1, M2: 427 H1: 352 | M1, M2: 640 H1: 527 | M1, M2: 853 H1: 703 |
| Área refrigerada Refrigerated area Zone réfrigérée | (x m²) | M1, M2: 1,00 H1: 0,82 | M1, M2: 1,51 H1: 1,22 | M1, M2: 2,01 H1: 1,63 | M1, M2: 3,01 H1: 2,45 | M1, M2: 4,01 H1: 3,26 |
| Niveles Exposición Exposition Levels Niveaux d'exposition | | M1-M2: 4+Expos. H1: 3+Expos. | | | | |
| Costados [2] Sides [2] Joues [2] | (mm) | 40 + 40 | | | | |
| Puertas Doors Portes | | - | - | - | - | - |
| Sistema de frío Cooling System Système de froid | | Ventilado / Ventilated / Ventilé | | | | |
| Desescarche Defrost Dégivrage | | Automático / Automatic / Automatique | | | | |
| Evaporación Evaporation Evaporation | | Forzada / Forced / Ventilé | | | | |
| Potencia Power Puissance | (W) | M1: 587 M2: - H1: 587 | M1: 858 M2: 858 H1: 858 | M1: 1250 M2: 1250 H1: 1250 | M1: 2413 M2: 2413 H1: 2413 | M1: 2374 M2: 2374 H1: 2374 |
| Potencia frig. Cooling capacity Puissance Frig. | (W A -10°C) | - | - | - | - | - |
| Consumo Consumption Consommation | (kWh/ 24h) | M1: 7,05 M2: 6,7 H1: 6,7 | M1: 10,3 M2: 9,8 H1: 9,3 | M1: 14,9 M2: 14,4 H1: 13,5 | M1: 26,1 M2: 25,7 H1: 24,3 | M1: 29,9 M2: 28,7 H1: 26,9 |
| Refrigerante Refrigerant Gaz | | R-290 | | | | |
| Colores estándar Standar colors Couleurs standard | | Ext. Estándar / Standar / Standard | | | Laterales / Sides / Joues | |
| | | Blanco/White/ Blanc | Ral 1015 | Ral 1018 | No incluidos / Not includes / Non inclus | |
| | | Ral 2003 | Ral 3003 | Ral 3020 | | |
| Laterales disponibles Available sides Joues disponibles | | Ral 5015 | Ral 5017 | Ral 5011 | Int. Estándar / Standar / Standard | |
| | | Ral 6002 | Ral 6018 | Ral 6019 | Blanco/White/ Blanc | Negro/Black/ Noir |
| | | Ral 7035 | Ral 7037 | Ral 7042 | Ral 7016 | |
| | | Ral 7016 | Ral 9006 | Negro/Black/ Noir | | |
| Opciones pág. 426-427 Options pages 426-427 Options pages 426-427 | | | | | | |

Serie / Series / Série **MP (MUNICH)**

+Info: www.infrico.com



MS18 P H1



**Nuevo
paragolpes
frontal**

**New
front
bumper**

**Nouveau
pare-chocs
frontale**



MS18 P M2

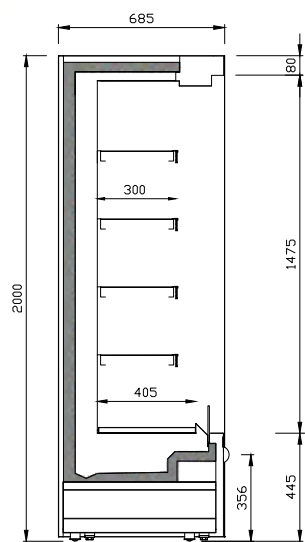

MS P M1/M2

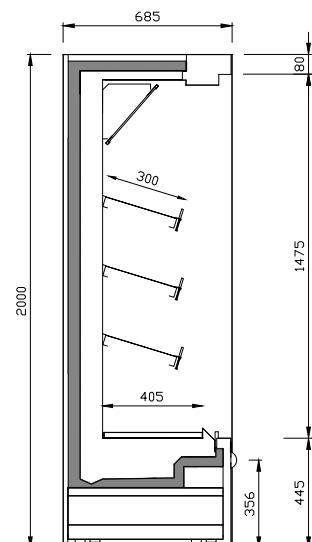

MS P H1



Mural plug in de refrigeración abierta frente bajo

Plug in refrigeration open low front multidecks

Murale de réfrigération ouverte groupe incorporé avec frontal bas

N: 785

| MODELO MODELE MODÈLE | | | | | | |
|---|-------------------------|--|------------------------------|-------------------------------|---|-------------------------------|
| Precio Price Prix | M1 / C M1 | 2.655 / 2.722 € | 3.196 / 3.273 € | 3.629 / 3.714 € | 5.390 / 5.510 € | 5.765 / 5.893 € |
| MOD. | MN6 P M2 / PC M2 | MN9 P M2 / PC M2 | MN12 P M2 / PC M2 | MN18 P M2 / PC M2 | MN25 P M2 / PC M2 | |
| Precio Price Prix | M2 / C M2 | 2.655 / 2.722 € | 3.196 / 3.273 € | 3.629 / 3.714 € | 5.390 / 5.510 € | 5.765 / 5.893 € |
| MOD. | MN6 P H1 / PC H1 | MN9 P H1 / PC H1 | MN12 P H1 / PC H1 | MN18 P H1 / PC H1 | MN25 P H1 / PC H1 | |
| Precio Price Prix | H1 / C H1 | 2.689 / 2.755 € | 3.235 / 3.313 € | 3.672 / 3.758 € | 5.450 / 5.571 € | 5.830 / 5.959 € |
| MOD. | - | MN9 PI M1 / PI M2 | MN12 PI M1 / PI M2 | MN18 PI M1 / PI M2 | - | |
| Precio Price Prix | INOX M1 / M2 | - | 3.548 / 3.548 € | 4.043 / 4.043 € | 6.073 / 6.073 € | - |
| Medidas Measures Mesures | (mm) | 625 x 785 x 2000 mm. | 938 x 785 x 2000 mm. | 1250 x 785 x 2000 mm. | 1875 x 785 x 2000 mm. | 2500 x 785 x 2000 mm. |
| Tª. Prod. Aplic. Prod. Tª. Applic. Tª. (°C) Temp. Prod. Temp. Appliq. | | M1: -1/+5°C 0/+2°C | | M2: -1/+7°C +2/+4°C | H1: +1/+10°C +4/+6°C | |
| Clase Climática Climatic class Classe climatique | (°C) | 3 / 25°C | | | | |
| Tensión/Frecuencia Electrical data Tension électrique | | 230V/1ph/50Hz | | | | |
| Controlador Controller Régulateur | | Digital | | | | |
| Material Material Matériel | [EXT/INT] | Acero galvanizado plastificado / Plastified galvanised steel / Acier galvanisé plastifié | | | | |
| Aislamiento Isolation Isolation | (mm) | 40kg/m³ / Free CFC's / Zero ODP-GWP | | | | |
| Capacidad Capacity Capacité | (L) | M1, M2: 279 H1: 229 | M1, M2: 419 H1: 344 | M1, M2: 558 H1: 458 | M1, M2: 837 H1: 687 | M1, M2: 1116 H1: 916 |
| Área refrigerada Refrigerated area Zone réfrigérée | (x m²) | M1, M2: 1,32 H1: 1,07 | M1, M2: 1,97 H1: 1,60 | M1, M2: 2,63 H1: 2,13 | M1, M2: 3,95 H1: 3,20 | M1, M2: 4,26 H1: 3,04 |
| Niveles Exposición Exposition Levels Niveaux d'exposition | | M1-M2: 4+Expos. H1: 3+Expos. | | | | |
| Costados [2] Sides [2] Joues [2] | (mm) | 40 + 40 | | | | |
| Puertas Doors Portes | | - | - | - | - | - |
| Sistema de frío Cooling System Système de froid | | Ventilado / Ventilated / Ventilé | | | | |
| Desescarche Defrost Dégivrage | | Automático / Automatic / Automatique | | | | |
| Evaporación Evaporation Evaporation | | Forzada / Forced / Ventilé | | | | |
| Potencia Power Puissance | (W) | M1: - M2: - H1: - | M1: 833 M2: 833 H1: 833 | M1: 1225 M2: 1225 H1: 1225 | M1: 2413 M2: 2413 H1: 2143 | M1: 2449 M2: 2449 H1: 2449 |
| Potencia frig. Cooling capacity Puissance Frig. | (W A -10°C) | - | - | - | - | - |
| Consumo Consumption Consommation | (kWh/ 24h) | M1: - M2: - H1: - | M1: 12.7 M2: 11.3 H1: 9.3 | M1: 17.1 M2: 17.8 H1: 13.3 | M1: 26.7 M2: 24.2 H1: 21.6 | M1: 29.1 M2: 28.7 H1: 23.9 |
| Refrigerante Refrigerant Gaz | | R-290 | | | | |
| Colores estándar Standar colors Couleurs standard | | Ext. Estándar / Standar / Standard | | | Laterales / Sides / Joues | |
| | | Blanco/White/ Blanc | Ral 1015 | Ral 1018 | No Incluidos / Not includes / Non inclus | |
| | | Ral 2003 | Ral 3003 | Ral 3020 | | |
| Laterales disponibles Available sides Joues disponibles | | Ral 5015 | Ral 5017 | Ral 5011 | Int. Estándar / Standar / Standard | |
| | | Ral 6002 | Ral 6018 | Ral 6019 | Blanco/White/ Blanc | |
| | | Ral 7035 | Ral 7037 | Ral 7042 | Negro/Black/ Noir | |
| | | Ral 7016 | Ral 9006 | Negro/Black/ Noir | Ral 7016 | |
| Opciones pág. 426-427 Options pages 426-427 Options pages 426-427 | | | | | | |
| | | | | | | |

Serie / Series / Série **MP (MUNICH)**

+Info: www.infrico.com

MN18 P M2



MN18 P H1

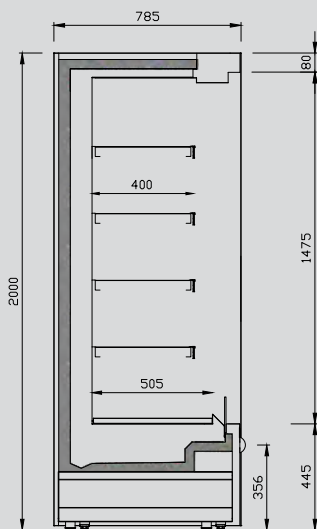

MN P M1/M2

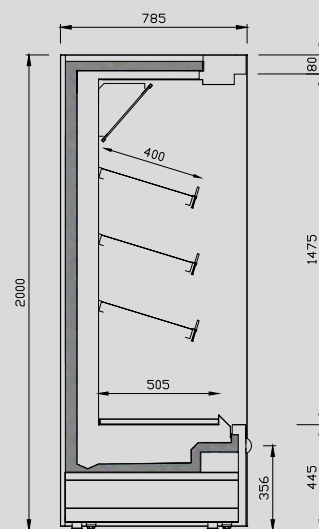

MN P H1





Mural plug in de refrigeración abierta frente bajo

Plug in refrigeration open low front multidecks

Murale de réfrigération ouverte groupe incorporé avec frontal bas



| MODELO MODELE MODÈLE | | | | | | |
|---|-------------------------|---|-------------------------------|-------------------------------|---|-------------------------------|
| Precio Price Prix | M1 / C M1 | 2.697 / 2.765 € | 3.249 / 3.326 € | 3.690 / 3.777 € | 5.485 / 5.608 € | 5.867 / 5.998 € |
| MOD. | ML6 P M2 / PC M2 | ML9 P M2 / PC M2 | ML12 P M2 / PC M2 | ML18 P M2 / PC M2 | ML25 P M2 / PC M2 | |
| Precio Price Prix | M2 / C M2 | 2.697 / 2.765 € | 3.249 / 3.326 € | 3.690 / 3.777 € | 5.485 / 5.608 € | 5.867 / 5.998 € |
| MOD. | ML6 P H1 / PC H1 | ML9 P H1 / PC H1 | ML12 P H1 / PC H1 | ML18 P H1 / PC H1 | ML25 P H1 / PC H1 | |
| Precio Price Prix | H1 / C H1 | 2.731 / 2.798 € | 3.288 / 3.366 € | 3.734 / 3.821 € | 5.546 / 5.670 € | 5.933 / 6.064 € |
| MOD. | - | ML9 PI M1 / PI M2 | ML12 PI M1 / PI M2 | ML18 PI M1 / PI M2 | - | |
| Precio Price Prix | INOX M1 / M2 | - | 3.522 / 3.522 € | 4.025 / 4.025 € | 6.095 / 6.095 € | - |
| Medidas Measures Mesures (mm) | | 625 x 885 x 2000 mm. | 938 x 885 x 2000 mm. | 1250 x 885 x 2000 mm. | 1875 x 885 x 2000 mm. | 2500 x 885 x 2000 mm. |
| Tª. Prod. Aplic. Prod. Tª. Applic. Tª. (°C) Temp. Prod. Temp. Appliq. | | M1: -1/+5°C 0/+2°C | | M2: -1/+7°C +2/+4°C | H1: +1/+10°C +4/+6°C | |
| Clase Climática Climatic class Classe climatique (°C) | | 3 / 25°C | | | | |
| Tensión/Frecuencia Electrical data Tension électrique | | 230V/1ph/50Hz | | | | |
| Controlador Controller Régulateur | | Digital | | | | |
| Material Material Matériel [EXT/INT] | | Acero galvanizado plastificado / Plastified galvanised steel / Acier galvanisé plastifié | | | | |
| Aislamiento Isolation Isolation (mm) | | 40kg/m³ / Free CFC's / Zero ODP-GWP | | | | |
| Capacidad Capacity Capacité (L) | | M1, M2: 295 H1: 245 | M1, M2: 442 H1: 367 | M1, M2: 589 H1: 489 | M1, M2: 884 H1: 734 | M1, M2: 1178 H1: 978 |
| Área refrigerada Refrigerated area Zone réfrigérée (x m²) | | M1, M2: 1,38 H1: 1,13 | M1, M2: 2,07 H1: 1,69 | M1, M2: 2,76 H1: 2,26 | M1, M2: 4,13 H1: 3,38 | M1, M2: 5,51 H1: 4,51 |
| Niveles Exposición Exposition Levels Niveaux d'exposition | | M1-M2: 4+Expos. H1: 3+Expos. | | | | |
| Costados [2] Sides [2] Joues [2] (mm) | | 40 + 40 | | | | |
| Puertas Doors Portes | | - | - | - | - | - |
| Sistema de frío Cooling System Système de froid | | Ventilado / Ventilated / Ventilé | | | | |
| Desescarche Defrost Dégivrage | | Automático / Automatic / Automatique | | | | |
| Evaporación Evaporation Evaporation | | Forzada / Forced / Ventilé | | | | |
| Potencia Power Puissance (W) | | M1: - M2: - H1: - | M1: 833 M2: 833 H1: 833 | M1: 1225 M2: 1225 H1: 1225 | M1: 2338 M2: 2338 H1: 2338 | M1: 2374 M2: 2374 H1: 2374 |
| Potencia frig. Cooling capacity Puissance Frig. (W A -10°C) | | - | - | - | - | - |
| Consumo Consumption Consommation (kWh/24h) | | M1: - M2: - H1: - | M1: 12.1 M2: 11.4 H1: 9.44 | M1: 17.5 M2: 18.1 H1: 13.6 | M1: 27.3 M2: 24.7 H1: 22.1 | M1: 29.6 M2: 27.7 H1: 24.4 |
| Refrigerante Refrigerant Gaz | | R-290 | | | | |
| Colores estándar Standar colors Couleurs standard | | Ext. Estándar / Standar / Standard | | | Laterales / Sides / Joues | |
| | | Blanco/White/ Blanc | Ral 1015 | Ral 1018 | No Incluidos / Not includes / Non inclus | |
| | | Ral 2003 | Ral 3003 | Ral 3020 | | |
| Laterales disponibles Available sides Joues disponibles | | Ral 5015 | Ral 5017 | Ral 5011 | Int. Estándar / Standar / Standard | |
| | | Ral 6002 | Ral 6018 | Ral 6019 | Blanco/White/ Blanc | |
| | | Ral 7035 | Ral 7037 | Ral 7042 | Negro/Black/ Noir | |
| | | Ral 7016 | Ral 9006 | Negro/Black/ Noir | Ral 7016 | |
| Opciones pág. 426-427 Options pages 426-427 Options pages 426-427 | |   | | | | |

Serie / Series / Série **MP (MUNICH)**

+Info: www.infrico.com

ML18 P H1



**Nuevo
paragolpes
frontal**

**New
front
bumper**

**Nouveau
pare-chocs
frontale**



ML18 P M2

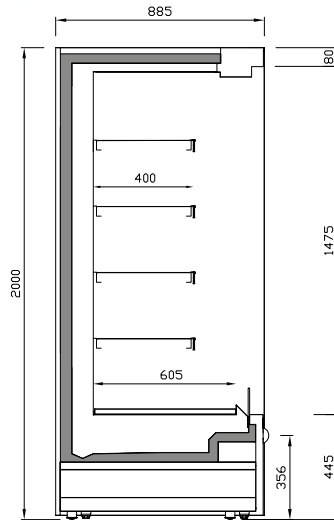

ML P M1/M2

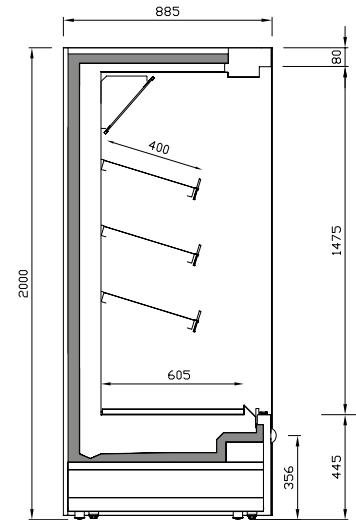

ML P H1







The technical data are subject to possible variations that may occur without notice. The company is not responsible for the use of the product. The company is not responsible for the use of the product. The company is not responsible for the use of the product.

Murales Experience para Quesos y Bacalao

Plug in R-290 Experience multidecks for cheese and codfish

Murale Experience de réfrigération groupe incorporé R-290 pour le fromage et la morue



| MODELO MODELE MODÈLE | QUESOS / CHEESE / FROMAGE | | BACALAO / CODFISH / MORUE | |
|---|--|-----------------------------|---|-----------------------------|
| | MS 9 BA M1 | MS 12 BA M1 | MS 9 DC BA M1 | MS 12 DC BA M1 |
| Precio Price Prix | 4.337 € | 4.942 € | 4.944 € | 5.476 € |
| Medidas Measures Mesures [mm] | 938 x 685 x 2000 mm. | 1250 x 685 x 2000 mm. | 938 x 685 x 2000 mm. | 1250 x 685 x 2000 mm. |
| T°. Prod. Aplic. Prod. T°. Applic. T°. [°C] Temp. Prod. Temp. Appliq. | M1: -1/+5°C 0/+2°C | | | |
| Clase Climática Climatic class Classe climatique [°C] | 3 / 25°C | | | |
| Tensión/Frecuencia Electrical data Tension électrique | 230V/1ph/50Hz | | | |
| Controlador Controller Régulateur | Digital | | | |
| Material Matériel [EXT/INT] | EXT: Acero inox AISI304 / Stainless Steel AISI304 / Acier inox AISI304 INT: Acero inox AISI304 (ventiladores, cubre evaporador, cuba) / Stainless Steel AISI304 (fans, cooler cover, tank) / Acier inox AISI304 (ventilateurs, couvercle évaporateur, bac) INT en contacto con producto / in contact with product / en contact avec le produit : Acero inox AISI316 / Stainless Steel AISI316 / Acier inox AISI316 | | | |
| Aislamiento Isolation Isolation [mm] | 40kg/m ³ / Free CFC's / Zero ODP-GWP | | | |
| Capacidad Capacity Capacité [L] | 321 | 428 | 321 | 428 |
| Superficie exposición Surface exhibition Surface d'exposition [x m ²] | 1,51 | 2,01 | 1,51 | 2,01 |
| Compresor Compressor Compresseur [HP] | 3/4 | 3/4 | 1 | 1+1/4 |
| Niveles Exposición Exposition Levels Niveaux d'exposition | - | | | |
| Costados [2] Sides [2] Joues [2] [mm] | 40+40 | | | |
| Sistema de frío Cooling System Système de froid | Ventilado / Ventilated / Ventilé | | | |
| Desescarche Defrost Dégivrage | Automático / Automatic / Automatique | | | |
| Evaporación Evaporation Évaporation | Forzada / Forced / Ventilé | | | |
| Potencia Power Puissance [W] | 858 | 1250 | 602 | 715 |
| Potencia frig. Cooling capacity Puissance Frig. [W A -10°C] | - | | | |
| Consumo Consumption Consommation [kWh/ 24h] | 10,3 | 14,9 | 8,9 | 9,9 |
| Refrigerante Refrigerant Gaz | R-290 | | | |
| Colores estándar Standar colors Couleurs standard | Color exterior / Exterior color / Couleur extérieure  | |   | |
| Laterales disponibles Available sides Joues disponibles | Color interior / Interior color / Couleur intérieure  | | | |
| Opciones pág. 426-427 Options pages 426-427 Options pages 426-427 | | | | |

Serie / Series / Série **MSBA (OPORTO)**
 Serie / Series / Série **MSDCBA (ORLEANS)**

+Info: www.infrico.com

MS 12 DC BA



MS 9 BA

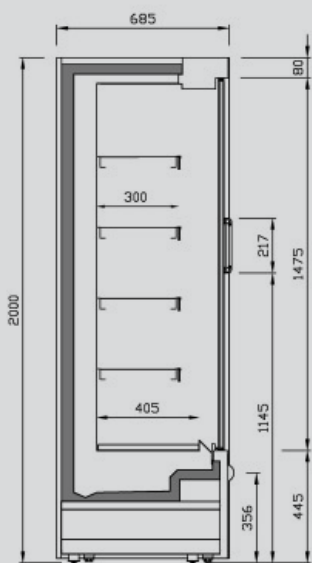

MS DC BA



Nuevo paragolpes frontal

New front bumper

Nouveau pare-chocs frontale

Evaporador anticorrosión con tratamiento de cataforesis

Anti-corrosion evaporator with cataphoresis treatment

Evaporateur anti-corrosion avec traitement par cataphorèse



**Cataforesis
 Cataphoresis
 Cataphorèse**

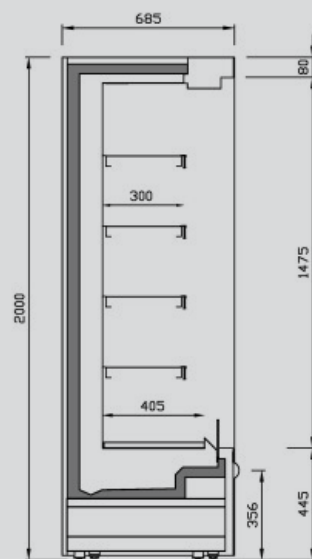

MS BA









Mural remota de refrigeración cerrada frente medio

Remote refrigeration doors middle front multideck

Murale de réfrigération fermée groupe à distance front moyenne



| MODELO MODELE MODÈLE | |  |  |  |  |
|---|------------------------------------|--|---|---|--|
| Precio Price Prix | M1 | 3.859 € | 5.108 € | 6.131 € | 8.203 € |
| MOD. | | MN12 DR M2 | MN18 DR M2 | MN25 DR M2 | MN37 DR M2 |
| Precio Price Prix | M2 | 3.859 € | 5.108 € | 6.131 € | 8.203 € |
| MOD. | | MN12 DR H1 | MN18 DR H1 | MN25 DR H1 | MN37 DR H1 |
| Precio Price Prix | H1 | 3.928 € | 5.203 € | 6.246 € | 8.359 € |
| Medidas / Measures / Mesures / [mm] | | 1250 x 785 x 2050 mm. | 1875 x 785 x 2050 mm. | 2500 x 785 x 2050 mm. | 3750 x 785 x 2050 mm. |
| Sin costados / Without sides / Sans joues | | | | | |
| T°. Prod. Aplic. Prod. T°. Applic. T°. [°C] Temp. Prod. Temp. Appliq. | | M1: -1/+5°C 0/+2°C M2: -1/+7°C +2/+4°C H1: +1/+10°C +4/+6°C | | | |
| Clase Climática Climatic class [°C] Classe climatique | | 3 / 25°C | | | |
| Tensión/Frecuencia Electrical data Tension électrique | | 230V/1ph/50Hz | | | |
| Controlador Controller Régulateur | | Digital | | | |
| Material Material Matériel [EXT/INT] | | Acero galvanizado plastificado / Plastified galvanised steel / Acier galvanisé plastifié | | | |
| Aislamiento Isolation Isolation [mm] | | 40kg/m³ / Free CFC's / Zero ODP-GWP | | | |
| Capacidad Capacity Capacité [L] | | M1, M2: 505 H1: 423 | M1, M2: 758 H1: 634 | M1, M2: 1010 H1: 845 | M1, M2: 1515 H1: 1268 |
| Superficie exposición Surface exhibition [x m²] Surface d'exposition | | 1,65 | 2,47 | 3,30 | 5,04 |
| Niveles Exposición Exposition Levels Niveaux d'exposition | | M1, M2: 4+Expos. H1: 3+Expos. | | | |
| Costados [2] Sides [2] Joues [2] [mm] | | 40 + 40 | | | |
| Puertas Doors Portes | | 2 | 3 | 4 | 6 |
| Sistema de frío Cooling System Système de froid | | Ventilado / Ventilated / Ventilé | | | |
| Desescarche Defrost Dégivrage | | Automático / Automatic / Automatique | | | |
| Evaporación Evaporation Évaporation | | Forzada / Forced / Ventilé | | | |
| Potencia Power Puissance [W] | | - | | | |
| Potencia frig. Cooling capacity Puissance Frig. [W A -10°C] | | M1: 850 M2: 734 H1: 606 | M1: 1275 M2: 1101 H1: 908 | M1: 1701 M2: 1468 H1: 1211 | M1: 2551 M2: 2202 H1: 1817 |
| Consumo Consumption Consommation [kWh/ 24h] | | - | | | |
| Refrigerante Refrigerant Gaz | | FREON | | | |
| Colores estándar Standard colors Couleurs standard | Int. Estándar / Standar / Standard | Blanco/White/ Blanc | Negro/Black/ Noir | Ral 7016 | Laterales / Sides / Joues No Incluidos / Not includes / Non inclus |
| | Ext. Estándar / Standar / Standard | Blanco/White/ Blanc | Ral 1015 | Ral 1018 | |
| Laterales disponibles Available sides Joues disponibles | | Ral 2003 | Ral 3003 | Ral 3020 |  Lateral Espejo Mirror end panels Joue Miroir |
| | | Ral 5015 | Ral 5017 | Ral 5011 | |
| Opciones pág. 426-427 Options pages 426-427 Options pages 426-427 | | Ral 6002 | Ral 6018 | Ral 6019 |  Lat. Panorámico Panoramic end panels Joue panoramique |
| | | Ral 7035 | Ral 7037 | Ral 7042 | |
| | | Ral 7016 | Ral 9006 | Negro/Black/ Noir | |

Serie / Series / Série **MDR (RIMINI)**

+Info: www.infrico.com

MN25DR M1

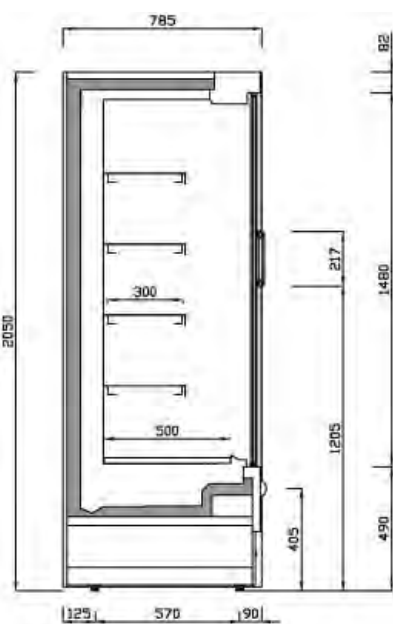

MN DR M1/M2



Nuevo paragolpes frontal

New front bumper

Nouveau pare-chocs frontale

Frente medio
Middle front
Front moyenne

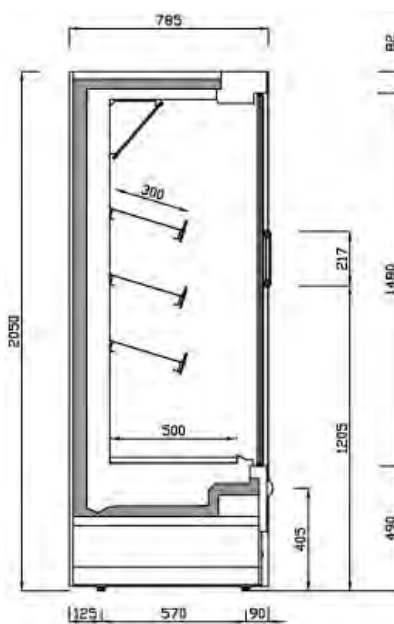

MN DR H1





Mural remota de refrigeración cerrada frente medio

Remote refrigeration doors middle front multideck

Murale de réfrigération fermée groupe à distance front moyenne



| MODELO MODELE MODÈLE | ML12 DR M1 | ML18 DR M1 | ML25 DRM1 | ML31 DRM1 | ML37 DR M1 | |
|---|--|-----------------------------|--|---|-----------------------------|--|
| Precio Price Prix | M1 3.930 € | 5.255 € | 6.249 € | 7.299 € | 8.362 € | |
| MOD. | ML12 DR M2 | ML18 DR M2 | ML25 DR M2 | ML31 DR M2 | ML37 DR M2 | |
| Precio Price Prix | M2 3.930 € | 5.255 € | 6.249 € | 7.299 € | 8.362 € | |
| MOD. | ML12 DR H1 | ML18 DR H1 | ML25 DR H1 | ML31 DR H1 | ML37 DR H1 | |
| Precio Price Prix | H1 4.002 € | 5.353 € | 6.366 € | 7.437 € | 8.522 € | |
| Medidas / Measures / Mesures / [mm] Sin costados / Without sides / Sans joues | 1250 x 885 x 2050 mm. | 1875 x 885 x 2050 mm. | 2500 x 885 x 2050 mm. | 3125 x 885 x 2050 mm. | 3750 x 885 x 2050 mm. | |
| T°. Prod. Aplic. Prod. T°. Applic. T°. [°C] Temp. Prod. Temp. Appliq. | M1: -1/+5°C 0/+2°C M2: -1/+7°C +2/+4°C H1: +1/+10°C +4/+6°C | | | | | |
| Clase Climática Climatic class [°C] Classe climatique | 3 / 25°C | | | | | |
| Tensión/Frecuencia Electrical data Tension électrique | 230V/1ph/50Hz | | | | | |
| Controlador Controller Régulateur | Digital | | | | | |
| Material Material Matériel [EXT/INT] | Acero galvanizado plastificado / Plastified galvanised steel / Acier galvanisé plastifié | | | | | |
| Aislamiento Isolation Isolation [mm] | 40kg/m ³ / Free CFC's / Zero ODP-GWP | | | | | |
| Capacidad Capacity Capacité [L] | M1, M2: 588 H1: 488 | M1, M2: 881 H1: 731 | M1, M2: 1175 H1: 975 | M1, M2: 1469 H1: 1219 | M1, M2: 1763 H1: 1460 | |
| Superficie exposición Surface exhibition [x m ²] Surface d'exposition | M1, M2: 2,75 H1: 2,25 | M1, M2: 4,13 H1: 3,40 | M1, M2: 5,50 H1: 4,80 | M1, M2: 6,80 H1: 5,60 | M1, M2: 8,30 H1: 6,70 | |
| Niveles Exposición Exposition Levels Niveaux d'exposition | M1, M2: 4+Expos. H1: 3+Expos. | | | | | |
| Costados [2] Sides [2] Joues [2] [mm] | 40 + 40 | | | | | |
| Puertas Doors Portes | 2 | 3 | 4 | 5 | 6 | |
| Sistema de frío Cooling System Système de froid | Ventilado / Ventilated / Ventilé | | | | | |
| Desescarche Defrost Dégivrage | Automático / Automatic / Automatique | | | | | |
| Evaporación Evaporation Évaporation | Forzada / Forced / Ventilé | | | | | |
| Potencia Power Puissance [W] | - | | | | | |
| Potencia frig. Cooling capacity Puissance Frig. [W A -10°C] | M1: 895 H1: 638 | M2: 773 H1: 956 | M1: 1343 H1: 1159 | M2: 1545 H1: 1275 | M1: 1790 H1: 1594 | |
| Consumo Consumption Consommation [kWh/ 24h] | - | | | | | |
| Refrigerante Refrigerant Gaz | FREON | | | | | |
| Colores estándar Standard colors Couleurs standard | Int. Estándar / Standar / Standard | | | Laterales / Sides / Joues | | |
| | Blanco/White/ Blanc | Negro/Black/ Noir | Ral 7016 | No Incluidos / Not includes / Non inclus | | |
| Laterales disponibles Available sides Joues disponibles | Ext. Estándar / Standar / Standard | | |  Lateral Espejo Mirror end panels Joue Miroir | | |
| | Blanco/White/ Blanc | Ral 1015 | Ral 1018 | | | |
| Ral 2003 | Ral 3003 | Ral 3020 |  Lat. Panorámico Panoramic end panels Joue panoramique | | | |
| Ral 5015 | Ral 5017 | Ral 5011 | | | | |
| Ral 6002 | Ral 6018 | Ral 6019 | | | | |
| Ral 7035 | Ral 7037 | Ral 7042 | | | | |
| Ral 7016 | Ral 9006 | Negro/Black/ Noir | | | | |
| Opciones pág. 426-427 Options pages 426-427 Options pages 426-427 |  Lateral Display Display end panels Joue Display | | | | | |

Serie / Series / Série **MDR (RIMINI)**

+Info: www.infrico.com

ML37 DR M1



Nuevo paragolpes frontal

New front bumper

Nouveau pare-chocs frontale

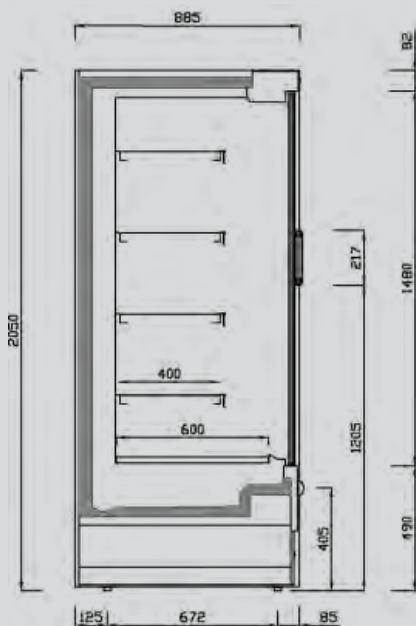

ML DR M1/M2

Frente medio
Middle front
Front moyenne

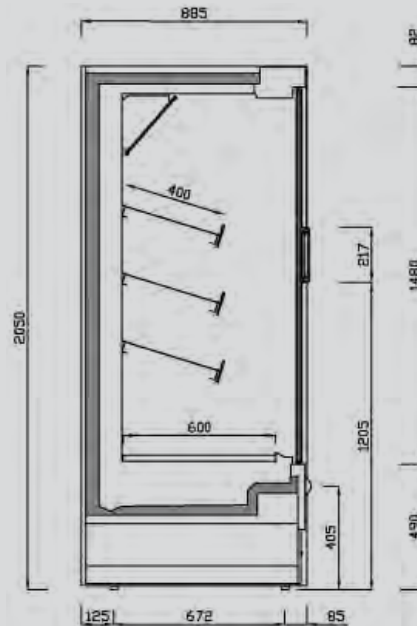

ML DR H1









Mural remota de refrigeración cerradas

Remote refrigeration doors multideck

Murales de réfrigération fermée groupe à distance



| MODELO MODELE MODÈLE |  |  |  |  | | | | |
|---|--|---|--|---|-------------------------------|--|--|--|
| Precio Price Prix | M1 | 3.859 € | 5.108 € | 6.131 € | 8.203 € | | | |
| MOD. | MS12 DG M2 | MS18 DG M2 | MS25 DG M2 | MS37 DG M2 | | | | |
| Precio Price Prix | M2 | 3.859 € | 5.108 € | 6.131 € | 8.203 € | | | |
| MOD. | MS12 DG H1 | MS18 DG H1 | MS25 DG H1 | MS37 DG H1 | | | | |
| Precio Price Prix | H1 | 3.928 € | 5.203 € | 6.246 € | 8.281 € | | | |
| Medidas / Measures / Mesures / (mm) | | 1250 x 680 x 2050 mm. | 1875 x 680 x 2050 mm. | 2500 x 680 x 2050 mm. | 3750 x 680 x 2050 mm. | | | |
| Sin costados / Without sides / Sans joues | | | | | | | | |
| T°. Prod. Aplic. Prod. T°. Applic. T°. (°C) Temp. Prod. Temp. Appliq. | M1: -1/+5°C 0/+2°C M2: -1/+7°C +2/+4°C H1: +1/+10°C +4/+6°C | | | | | | | |
| Clase Climática Climatic class Classe climatique (°C) | 3 / 25°C | | | | | | | |
| Tensión/Frecuencia Electrical data Tension électrique | 230V/1ph/50Hz | | | | | | | |
| Controlador Controller Régulateur | Digital | | | | | | | |
| Material Material Matériel (EXT/INT) | Acero galvanizado plastificado / Plastified galvanised steel / Acier galvanisé plastifié | | | | | | | |
| Aislamiento Isolation Isolation (mm) | 40kg/m ³ / Free CFC's / Zero ODP-GWP | | | | | | | |
| Capacidad Capacity Capacité (L) | | M1, M2: 401 H1: 326 | M1, M2: 602 H1: 489 | M1, M2: 803 H1: 653 | M1, M2: 1204 H1: 979 | | | |
| Superficie exposición Surface exhibition Surface d'exposition (x m ²) | | M1, M2: 2,01 H1: 1,63 | M1, M2: 3,01 H1: 2,45 | M1, M2: 4,01 H1: 3,26 | M1, M2: 6,02 H1: 4,89 | | | |
| Niveles Exposición Exposition Levels Niveaux d'exposition | M1, M2: 4+Expos. H1: 3+Expos. | | | | | | | |
| Costados (2) Sides (2) Joues (2) (mm) | 40 + 40 | | | | | | | |
| Puertas Doors Portes | | 2 | 3 | 4 | 6 | | | |
| Sistema de frío Cooling System Système de froid | Ventilado / Ventilated / Ventilé | | | | | | | |
| Desescarche Defrost Dégivrage | Automático / Automatic / Automatique | | | | | | | |
| Evaporación Evaporation Évaporation | Forzada / Forced / Ventilé | | | | | | | |
| Potencia Power Puissance (W) | - | | | | | | | |
| Potencia frig. Cooling capacity Puissance Frig. (W A -10°C) | | M1: 895 M2: 773 H1: 638 | M1: 1343 M2: 1159 H1: 956 | M1: 1790 M2: 1545 H1: 1275 | M1: 2685 M2: 2318 H1: 1913 | | | |
| Consumo Consumption Consommation (kWh/ 24h) | - | | | | | | | |
| Refrigerante Refrigerant Gaz | FREON | | | | | | | |
| Colores estándar Standar colors Couleurs standard | Int. Estándar / Standar / Standard | | | Laterales / Sides / Joues | | | | |
| | Blanco/White/ Blanc | Negro/Black/ Noir | Ral 7016 | No Incluidos / Not includes / Non inclus | | | | |
| Laterales disponibles Available sides Joues disponibles | Ext. Estándar / Standar / Standard | | |  Lateral Espejo Mirror end panels Joue Miroir | | | | |
| | Blanco/White/ Blanc | Ral 1015 | Ral 1018 | | |  Lat. Panorámico Panoramic end panels Joue panoramique | | |
| Ral 2003 | Ral 3003 | Ral 3020 |  Lateral Display Display end panels Joue Display | | | | | |
| Ral 5015 | Ral 5017 | Ral 5011 | | | | | | |
| Ral 6002 | Ral 6018 | Ral 6019 | | | | | | |
| Ral 7035 | Ral 7037 | Ral 7042 | | | | | | |
| Ral 7016 | Ral 9006 | Negro/Black/ Noir | | | | | | |
| Opciones pág. 426-427 Options pages 426-427 Options pages 426-427 | | | | | | | | |

Serie / Series / Série **MDG (PORTLAND)**

+Info: www.infrico.com



MS37DG M2



**Nuevo
paragolpes
frontal**

**New
front
bumper**

**Nouveau
pare-chocs
frontale**



MS25DG H1

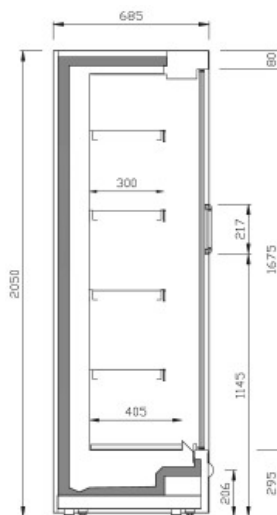

MS DG M1/M2

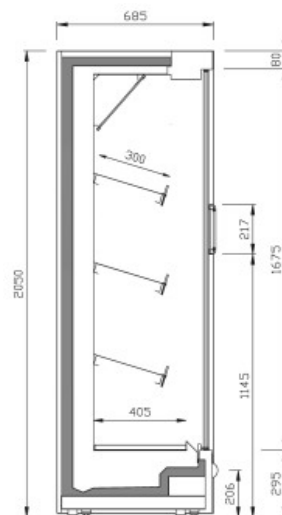

MS DG H1

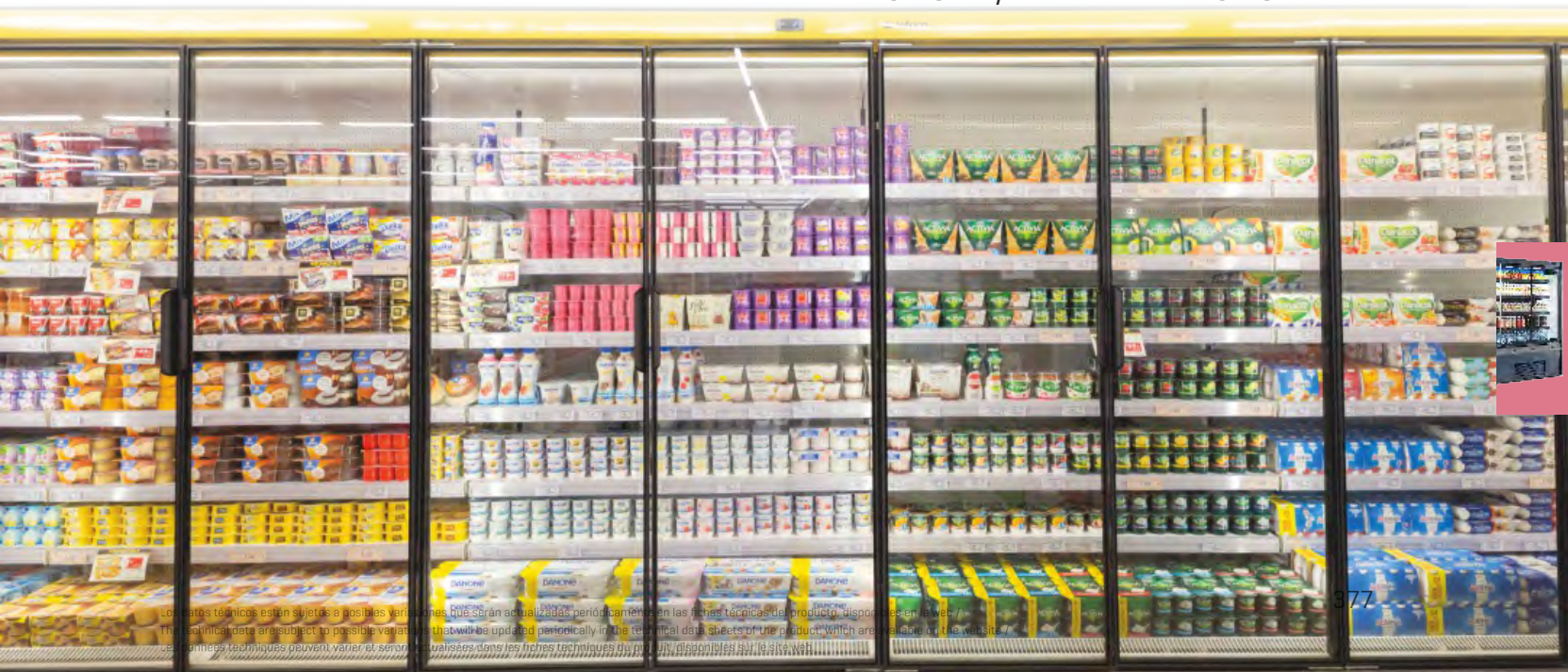







Mural remota de refrigeración cerradas

Remote refrigeration doors multideck

Murales de réfrigération fermée groupe à distance



| MODELO MODEL MODÈLE |  |  |  |  | | | | | | | | | | | | | | | | | | | | | |
|--|---|---|---|---|----------------------|---|----------------------|----------------------|----------|----------|----------|----------|----------|----------|----------|----------|----------|----------|----------|----------------------|--|--|------------------------|----------------------|----------|
| Precio Price Prix | M0 | 3.859 € | 5.108 € | 6.131 € | 8.203 € | | | | | | | | | | | | | | | | | | | | |
| MOD. | MN12 DG M1 | MN18 DG M1 | MN25 DG M1 | MN37 DG M1 | | | | | | | | | | | | | | | | | | | | | |
| Precio Price Prix | M1 | 3.859 € | 5.108 € | 6.131 € | 8.203 € | | | | | | | | | | | | | | | | | | | | |
| MOD. | MN12 DG M2 | MN18 DG M2 | MN25 DG M2 | MN37 DG M2 | | | | | | | | | | | | | | | | | | | | | |
| Precio Price Prix | M2 | 3.859 € | 5.108 € | 6.131 € | 8.203 € | | | | | | | | | | | | | | | | | | | | |
| MOD. | MN12 DG H1 | MN18 DG H1 | MN25 DG H1 | MN37 DG H1 | | | | | | | | | | | | | | | | | | | | | |
| Precio Price Prix | H1 | 3.928 € | 5.203 € | 6.246 € | 8.359 € | | | | | | | | | | | | | | | | | | | | |
| Medidas / Measures / Mesures / [mm] Sin costados / Without sides / Sans joues | 1250 x 785 x 2050 mm. | 1875 x 785 x 2050 mm. | 2500 x 785 x 2050 mm. | 3750 x 785 x 2050 mm. | | | | | | | | | | | | | | | | | | | | | |
| T°. Prod. Aplic. Prod. T°. Applic. T°. (°C) Temp. Prod. Temp. Appliq. | M0: -1/+4°C -1/+1°C M1: -1/+5°C 0/+2°C M2: -1/+7°C +2/+4°C H1: +1/+10°C +4/+6°C | | | | | | | | | | | | | | | | | | | | | | | | |
| Clase Climática Climatic class (°C) Classe climatique | 3 / 25°C | | | | | | | | | | | | | | | | | | | | | | | | |
| Tensión/Frecuencia Electrical data Tension électrique | 230V/1ph/50Hz | | | | | | | | | | | | | | | | | | | | | | | | |
| Controlador Controller Régulateur | Digital | | | | | | | | | | | | | | | | | | | | | | | | |
| Material Material (EXT/INT) Matériel | Acero galvanizado plastificado / Plastified galvanised steel / Acier galvanisé plastifié | | | | | | | | | | | | | | | | | | | | | | | | |
| Aislamiento Isolation [mm] Isolation | 40kg/m ³ / Free CFC's / Zero ODP-GWP | | | | | | | | | | | | | | | | | | | | | | | | |
| Capacidad Capacity [L] Capacité | M0, M1, M2: 766 H1: 655 | M0, M1, M2: 1149 H1: 983 | M0, M1, M2: 1533 H1: 1310 | M0, M1, M2: 2299 H1: 1965 | | | | | | | | | | | | | | | | | | | | | |
| Superficie exposición Surface exhibition [x m ²] Surface d'exposition | M0, M1, M2: 2,64 H1: 2,14 | M0, M1, M2: 3,96 H1: 3,21 | M0, M1, M2: 5,28 H1: 4,30 | M0, M1, M2: 7,91 H1: 6,40 | | | | | | | | | | | | | | | | | | | | | |
| Niveles Exposición Exposition Levels Niveaux d'exposition | M0, M1, M2: 4+Expos. H1: 3+Expos. | | | | | | | | | | | | | | | | | | | | | | | | |
| Costados [2] Sides [2] [mm] Joues [2] | 40 + 40 | | | | | | | | | | | | | | | | | | | | | | | | |
| Puertas Doors Portes | 2 | 3 | 4 | 6 | | | | | | | | | | | | | | | | | | | | | |
| Sistema de frío Cooling System Système de froid | Ventilado / Ventilated / Ventilé | | | | | | | | | | | | | | | | | | | | | | | | |
| Desescarche Defrost Dégivrage | Automático / Automatic / Automatique | | | | | | | | | | | | | | | | | | | | | | | | |
| Evaporación Evaporation Évaporation | Forzada / Forced / Ventilé | | | | | | | | | | | | | | | | | | | | | | | | |
| Potencia Power [W] Puissance | - | | | | | | | | | | | | | | | | | | | | | | | | |
| Potencia frig. Cooling capacity [W A -10°C] Puissance Frig. | M0: 986 M2: 773 | M1: 895 H1: 638 | M0: 1479 M2: 1159 | M1: 1343 H1: 956 | M0: 1973 M2: 1545 | M1: 1790 H1: 1275 | M0: 2959 M2: 2318 | M1: 2685 H1: 1913 | | | | | | | | | | | | | | | | | |
| Consumo Consumption [kWh/ 24h] Consommation | - | | | | | | | | | | | | | | | | | | | | | | | | |
| Refrigerante Refrigerant Gaz | FREON | | | | | | | | | | | | | | | | | | | | | | | | |
| Colores estándar Standard colors Couleurs standard | Ext. Estándar / Standar / Standard | | Int. Estándar / Standar / Standard | | | | | | | | | | | | | | | | | | | | | | |
| Laterales disponibles Available sides Joues disponibles | <table border="1"> <tr> <td>Blanco/White/ Blanc</td> <td>Ral 1015</td> <td>Ral 1018</td> </tr> <tr> <td>Ral 2003</td> <td>Ral 3003</td> <td>Ral 3020</td> </tr> <tr> <td>Ral 5015</td> <td>Ral 5017</td> <td>Ral 5011</td> </tr> <tr> <td>Ral 6002</td> <td>Ral 6018</td> <td>Ral 6019</td> </tr> <tr> <td>Ral 7035</td> <td>Ral 7037</td> <td>Ral 7042</td> </tr> <tr> <td>Ral 7016</td> <td>Ral 9006</td> <td>Negro/Black/ Noir</td> </tr> </table> | | Blanco/White/ Blanc | Ral 1015 | Ral 1018 | Ral 2003 | Ral 3003 | Ral 3020 | Ral 5015 | Ral 5017 | Ral 5011 | Ral 6002 | Ral 6018 | Ral 6019 | Ral 7035 | Ral 7037 | Ral 7042 | Ral 7016 | Ral 9006 | Negro/Black/ Noir | <table border="1"> <tr> <td>Blanco/White/ Blanc</td> <td>Negro/Black/ Noir</td> <td>Ral 7016</td> </tr> </table> | | Blanco/White/ Blanc | Negro/Black/ Noir | Ral 7016 |
| Blanco/White/ Blanc | Ral 1015 | Ral 1018 | | | | | | | | | | | | | | | | | | | | | | | |
| Ral 2003 | Ral 3003 | Ral 3020 | | | | | | | | | | | | | | | | | | | | | | | |
| Ral 5015 | Ral 5017 | Ral 5011 | | | | | | | | | | | | | | | | | | | | | | | |
| Ral 6002 | Ral 6018 | Ral 6019 | | | | | | | | | | | | | | | | | | | | | | | |
| Ral 7035 | Ral 7037 | Ral 7042 | | | | | | | | | | | | | | | | | | | | | | | |
| Ral 7016 | Ral 9006 | Negro/Black/ Noir | | | | | | | | | | | | | | | | | | | | | | | |
| Blanco/White/ Blanc | Negro/Black/ Noir | Ral 7016 | | | | | | | | | | | | | | | | | | | | | | | |
| Opciones pág. 426-427 Options pages 426-427 Options pages 426-427 | <table border="1"> <tr> <td colspan="3">No Incluidos / Not includes / Non inclus</td> </tr> </table> | | No Incluidos / Not includes / Non inclus | | |    | | | | | | | | | | | | | | | | | | | |
| No Incluidos / Not includes / Non inclus | | | | | | | | | | | | | | | | | | | | | | | | | |
| | | | <p>Lateral Espejo Mirror end panels Joue Miroir</p> <p>Lat. Panorámico Panoramic end panels Joue panoramique</p> <p>Lateral Display Display end panels Joue Display</p> | | | | | | | | | | | | | | | | | | | | | | |

Serie / Series / Série **MDG (PORTLAND)**

+Info: www.infrico.com

MN25DG M2



**Nuevo
paragolpes
frontal**

**New
front
bumper**

**Nouveau
pare-chocs
frontale**



MN25DG H1

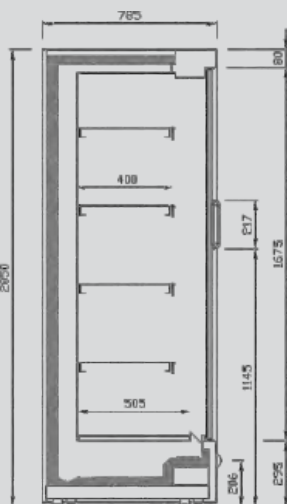

MN DG M0/M1/M2

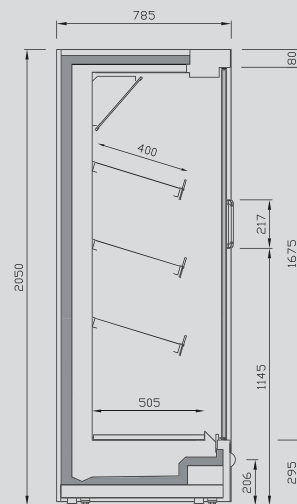

MN DG H1



Mural remota de refrigeración cerradas

Remote refrigeration doors multideck

Murales de réfrigération fermée groupe à distance

| MODELO MODEL MODÈLE | | | | | | | | | | | | | | | | | | | | | | | | | |
|--|---|--|--|---|---|----------|----------|----------|----------|----------|----------|----------|----------|----------|----------|----------|----------|----------|----------------------|--|------------------------|----------------------|----------|--|--|
| Precio Price Prix | M0 | 4.068 € | 5.393 € | 6.476 € | 8.673 € | | | | | | | | | | | | | | | | | | | | |
| MOD. | MN12 DG22 M1 | MN18 DG22 M1 | MN25 DG22 M1 | MN37 DG22 M1 | | | | | | | | | | | | | | | | | | | | | |
| Precio Price Prix | M1 | 4.068 € | 5.393 € | 6.476 € | 8.673 € | | | | | | | | | | | | | | | | | | | | |
| MOD. | MN12 DG22 M2 | MN18 DG22 M2 | MN25 DG22 M2 | MN37 DG22 M2 | | | | | | | | | | | | | | | | | | | | | |
| Precio Price Prix | M2 | 4.068 € | 5.393 € | 6.476 € | 8.673 € | | | | | | | | | | | | | | | | | | | | |
| MOD. | MN12 DG22 H1 | MN18 DG22 H1 | MN25 DG22 H1 | MN37 DG22 H1 | | | | | | | | | | | | | | | | | | | | | |
| Precio Price Prix | H1 | 4.141 € | 5.494 € | 6.598 € | 8.839 € | | | | | | | | | | | | | | | | | | | | |
| Medidas / Measures / Mesures / [mm] Sin costados / Without sides / Sans joues | | 1250 x 785 x 2200 mm. | 1875 x 785 x 2200 mm. | 2500 x 785 x 2200 mm. | 3750 x 785 x 2200 mm. | | | | | | | | | | | | | | | | | | | | |
| T°. Prod. Aplic. Prod. T°. Applic. T°. [°C] Temp. Prod. Temp. Appliq. | | M0: -1/+4°C -1/+1°C | M1: -1/+5°C 0/+2°C | M2: -1/+7°C +2/+4°C | H1: +1/+10°C +4/+6°C | | | | | | | | | | | | | | | | | | | | |
| Clase Climática Climatic class [°C] Classe climatique | | 3 / 25°C | | | | | | | | | | | | | | | | | | | | | | | |
| Tensión/Frecuencia Electrical data Tension électrique | | 230V/1ph/50Hz | | | | | | | | | | | | | | | | | | | | | | | |
| Controlador Controller Régulateur | | Digital | | | | | | | | | | | | | | | | | | | | | | | |
| Material Material [EXT/INT] Matériel | | Acero galvanizado plastificado / Plastified galvanised steel / Acier galvanisé plastifié | | | | | | | | | | | | | | | | | | | | | | | |
| Aislamiento Isolation [mm] Isolation | | 40kg/m ³ / Free CFC's / Zero ODP-GWP | | | | | | | | | | | | | | | | | | | | | | | |
| Capacidad Capacity [L] Capacité | | M0, M1, M2: 816 H1: 705 | M0, M1, M2: 1224 H1: 1058 | M0, M1, M2: 1633 H1: 1410 | M0, M1, M2: 2449 H1: 2115 | | | | | | | | | | | | | | | | | | | | |
| Superficie exposición Surface exhibition [x m ²] Surface d'exposition | | M0, M1, M2: 3,14 H1: 2,64 | M0, M1, M2: 4,71 H1: 3,96 | M0, M1, M2: 6,28 H1: 5,30 | M0, M1, M2: 9,41 H1: 7,90 | | | | | | | | | | | | | | | | | | | | |
| Niveles Exposición Exposition Levels Niveaux d'exposition | | M0, M1, M2: 5+Expos. H1: 4+Expos. | | | | | | | | | | | | | | | | | | | | | | | |
| Costados [2] Sides [2] [mm] Joues [2] | | 40 + 40 | | | | | | | | | | | | | | | | | | | | | | | |
| Puertas Doors Portes | | 2 | 3 | 4 | 6 | | | | | | | | | | | | | | | | | | | | |
| Sistema de frío Cooling System Système de froid | | Ventilado / Ventilated / Ventilé | | | | | | | | | | | | | | | | | | | | | | | |
| Desescarche Defrost Dégivrage | | Automático / Automatic / Automatique | | | | | | | | | | | | | | | | | | | | | | | |
| Evaporación Evaporation Évaporation | | Forzada / Forced / Ventilé | | | | | | | | | | | | | | | | | | | | | | | |
| Potencia Power [W] Puissance | | - | | | | | | | | | | | | | | | | | | | | | | | |
| Potencia frig. Cooling capacity [W A -10°C] Puissance Frig. | | M0: 1018 M1: 928 M2: 815 H1: 683 | M0: 1596 M1: 1391 M2: 1223 H1: 1024 | M0: 2035 M1: 1855 M2: 1630 H1: 1365 | M0: 3053 M1: 2783 M2: 2445 H1: 2048 | | | | | | | | | | | | | | | | | | | | |
| Consumo Consumption [kWh/ 24h] Consommation | | - | | | | | | | | | | | | | | | | | | | | | | | |
| Refrigerante Refrigerant Gaz | | FREON | | | | | | | | | | | | | | | | | | | | | | | |
| Colores estándar Standard colors Couleurs standard | Ext. Estándar / Standar / Standard | Int. Estándar / Standar / Standard | | | | | | | | | | | | | | | | | | | | | | | |
| Laterales disponibles Available sides Joues disponibles | <table border="1"> <tr> <td>Blanco/White/ Blanc</td> <td>Ral 1015</td> <td>Ral 1018</td> </tr> <tr> <td>Ral 2003</td> <td>Ral 3003</td> <td>Ral 3020</td> </tr> <tr> <td>Ral 5015</td> <td>Ral 5017</td> <td>Ral 5011</td> </tr> <tr> <td>Ral 6002</td> <td>Ral 6018</td> <td>Ral 6019</td> </tr> <tr> <td>Ral 7035</td> <td>Ral 7037</td> <td>Ral 7042</td> </tr> <tr> <td>Ral 7016</td> <td>Ral 9006</td> <td>Negro/Black/ Noir</td> </tr> </table> | Blanco/White/ Blanc | Ral 1015 | Ral 1018 | Ral 2003 | Ral 3003 | Ral 3020 | Ral 5015 | Ral 5017 | Ral 5011 | Ral 6002 | Ral 6018 | Ral 6019 | Ral 7035 | Ral 7037 | Ral 7042 | Ral 7016 | Ral 9006 | Negro/Black/ Noir | <table border="1"> <tr> <td>Blanco/White/ Blanc</td> <td>Negro/Black/ Noir</td> <td>Ral 7016</td> </tr> </table> | Blanco/White/ Blanc | Negro/Black/ Noir | Ral 7016 | | |
| Blanco/White/ Blanc | Ral 1015 | Ral 1018 | | | | | | | | | | | | | | | | | | | | | | | |
| Ral 2003 | Ral 3003 | Ral 3020 | | | | | | | | | | | | | | | | | | | | | | | |
| Ral 5015 | Ral 5017 | Ral 5011 | | | | | | | | | | | | | | | | | | | | | | | |
| Ral 6002 | Ral 6018 | Ral 6019 | | | | | | | | | | | | | | | | | | | | | | | |
| Ral 7035 | Ral 7037 | Ral 7042 | | | | | | | | | | | | | | | | | | | | | | | |
| Ral 7016 | Ral 9006 | Negro/Black/ Noir | | | | | | | | | | | | | | | | | | | | | | | |
| Blanco/White/ Blanc | Negro/Black/ Noir | Ral 7016 | | | | | | | | | | | | | | | | | | | | | | | |
| Opciones pág. 426-427 Options pages 426-427 Options pages 426-427 | | No Incluidos / Not includes / Non inclus | | Lateral Espejo Mirror end panels Joue Miroir | Lat. Panorámico Panoramic end panels Joue panoramique | | | | | | | | | | | | | | | | | | | | |
| | | | | Lateral Display Display end panels Joue Display | | | | | | | | | | | | | | | | | | | | | |

Serie / Series / Série **MDG (PORTLAND)**

+Info: www.infrico.com

MN37DG22 M2



**Nuevo
paragolpes
frontal**

**New
front
bumper**

**Nouveau
pare-chocs
frontale**



MN25DG22 H1

Lateral panorámico
Panoramic side panel
Joue panoramique

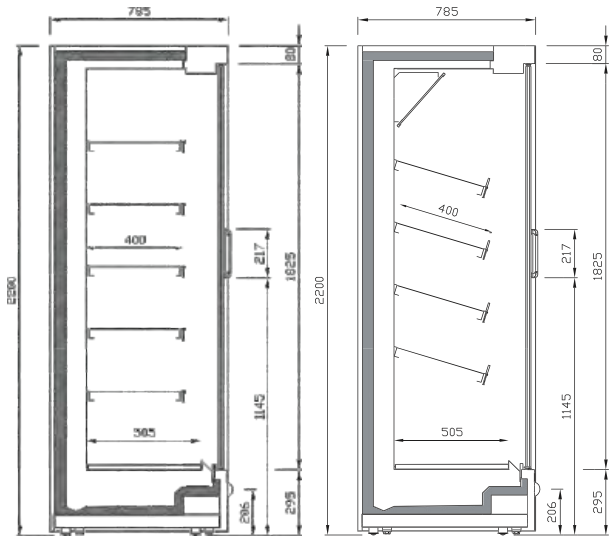

MN DG22 M0/M1/M2

MN DG22 H1











Mural remota de refrigeración cerradas

Remote refrigeration doors multideck

Murales de réfrigération fermée groupe à distance



| MODELO MODELE MODÈLE |  |  |  |  |  | | | | | | | | | | | | | | | | | | | | | | | | | | | | | | | | |
|---|---|---|---|---|---|-----------------------------|----------------------|--|----------------------|----------------------|----------------------|--|----------|----------|----------|--|----------|----------|----------|--|----------|----------|----------|--|----------|----------|----------------------|--|--|--|--|------------------------|----------------------|----------|---|--|--|
| Precio Price Prix | M0 | 3.930 € | 5.255 € | 6.249 € | 7.299 € | 8.362 € | | | | | | | | | | | | | | | | | | | | | | | | | | | | | | | |
| MOD. | ML12 DG M1 | ML18 DG M1 | ML25 DG M1 | ML31 DG M1 | ML37 DG M1 | | | | | | | | | | | | | | | | | | | | | | | | | | | | | | | | |
| Precio Price Prix | M1 | 3.930 € | 5.255 € | 6.249 € | 7.299 € | 8.362 € | | | | | | | | | | | | | | | | | | | | | | | | | | | | | | | |
| MOD. | ML12 DG M2 | ML18 DG M2 | ML25 DG M2 | ML31 DG M2 | ML37 DG M2 | | | | | | | | | | | | | | | | | | | | | | | | | | | | | | | | |
| Precio Price Prix | M2 | 3.930 € | 5.255 € | 6.249 € | 7.299 € | 8.362 € | | | | | | | | | | | | | | | | | | | | | | | | | | | | | | | |
| MOD. | ML12 DG H1 | ML18 DG H1 | ML25 DG H1 | ML31 DG H1 | ML37 DG H1 | | | | | | | | | | | | | | | | | | | | | | | | | | | | | | | | |
| Precio Price Prix | H1 | 4.002 € | 5.353 € | 6.366 € | 7.437 € | 8.522 € | | | | | | | | | | | | | | | | | | | | | | | | | | | | | | | |
| Medidas / Mesures / Mesures / [mm] Sin costados / Without sides / Sans joues | | 1250 x 885 x 2050 mm. | 1875 x 885 x 2050 mm. | 2500 x 885 x 2050 mm. | 3125 x 885 x 2050 mm. | 3750 x 885 x 2050 mm. | | | | | | | | | | | | | | | | | | | | | | | | | | | | | | | |
| T°. Prod. Aplic. Prod. T°. Applic. T°. (°C) Temp. Prod. Temp. Appliq. | | M0: -1/+4°C -1/+1°C M1: -1/+5°C 0/+2°C M2: -1/+7°C +2/+4°C H1: +1/+10°C +4/+6°C | | | | | | | | | | | | | | | | | | | | | | | | | | | | | | | | | | | |
| Clase Climática Climatic class (°C) Classe climatique | | 3 / 25°C | | | | | | | | | | | | | | | | | | | | | | | | | | | | | | | | | | | |
| Tensión/Frecuencia Electrical data Tension électrique | | 230V/1ph/50Hz | | | | | | | | | | | | | | | | | | | | | | | | | | | | | | | | | | | |
| Controlador Controller Régulateur | | Digital | | | | | | | | | | | | | | | | | | | | | | | | | | | | | | | | | | | |
| Material Material Matériel (EXT/INT) | | Acero galvanizado plastificado / Plastified galvanised steel / Acier galvanisé plastifié | | | | | | | | | | | | | | | | | | | | | | | | | | | | | | | | | | | |
| Aislamiento Isolation Isolation [mm] | | 40kg/m ³ / Free CFC's / Zero ODP-GWP | | | | | | | | | | | | | | | | | | | | | | | | | | | | | | | | | | | |
| Capacidad Capacity Capacité [L] | | 803 | 1204 | 1605 | 2006 | 2408 | | | | | | | | | | | | | | | | | | | | | | | | | | | | | | | |
| Superficie exposición Surface exhibition [x m ²] Surface d'exposition | | 2,76 | 4,13 | 5,51 | 6,80 | 8,30 | | | | | | | | | | | | | | | | | | | | | | | | | | | | | | | |
| Niveles Exposición Exposition Levels Niveaux d'exposition | | M0, M1, M2: 4+Expos. H1: 3+Expos. | | | | | | | | | | | | | | | | | | | | | | | | | | | | | | | | | | | |
| Costados [2] Sides [2] Joues [2] [mm] | | 40 + 40 | | | | | | | | | | | | | | | | | | | | | | | | | | | | | | | | | | | |
| Puertas Doors Portes | | 2 | 3 | 4 | 5 | 6 | | | | | | | | | | | | | | | | | | | | | | | | | | | | | | | |
| Sistema de frío Cooling System Système de froid | | Ventilado / Ventilated / Ventilé | | | | | | | | | | | | | | | | | | | | | | | | | | | | | | | | | | | |
| Desescarche Defrost Dégivrage | | Automático / Automatic / Automatique | | | | | | | | | | | | | | | | | | | | | | | | | | | | | | | | | | | |
| Evaporación Evaporation Évaporation | | Forzada / Forced / Ventilé | | | | | | | | | | | | | | | | | | | | | | | | | | | | | | | | | | | |
| Potencia Power Puissance [W] | | - | | | | | | | | | | | | | | | | | | | | | | | | | | | | | | | | | | | |
| Potencia frig. Cooling capacity Puissance Frig. [W A -10°C] | | M0: 986 M2: 773 | M1: 895 H1: 638 | M0: 1479 M2: 1159 | M1: 1343 H1: 956 | M0: 1973 M2: 1545 | M1: 1790 H1: 1275 | M0: 2466 M2: 1931 | M1: 2238 H1: 1594 | M0: 2959 M2: 2318 | M1: 2685 H1: 1913 | | | | | | | | | | | | | | | | | | | | | | | | | | |
| Consumo Consumption Consommation [kWh/ 24h] | | - | | | | | | | | | | | | | | | | | | | | | | | | | | | | | | | | | | | |
| Refrigerante Refrigerant Gaz | | FREON | | | | | | | | | | | | | | | | | | | | | | | | | | | | | | | | | | | |
| Colores estándar Standard colors Couleurs standard | | Ext. Estándar / Standar / Standard | | | Int. Estándar / Standar / Standard | | | | | | | | | | | | | | | | | | | | | | | | | | | | | | | | |
| Laterales disponibles Available sides Joues disponibles | | <table border="1"> <tr> <td>Blanco/White/ Blanc</td> <td>Ral 1015</td> <td>Ral 1018</td> <td></td> </tr> <tr> <td>Ral 2003</td> <td>Ral 3003</td> <td>Ral 3020</td> <td></td> </tr> <tr> <td>Ral 5015</td> <td>Ral 5017</td> <td>Ral 5011</td> <td></td> </tr> <tr> <td>Ral 6002</td> <td>Ral 6018</td> <td>Ral 6019</td> <td></td> </tr> <tr> <td>Ral 7035</td> <td>Ral 7037</td> <td>Ral 7042</td> <td></td> </tr> <tr> <td>Ral 7016</td> <td>Ral 9006</td> <td>Negro/Black/ Noir</td> <td></td> </tr> </table> | | | Blanco/White/ Blanc | Ral 1015 | Ral 1018 | | Ral 2003 | Ral 3003 | Ral 3020 | | Ral 5015 | Ral 5017 | Ral 5011 | | Ral 6002 | Ral 6018 | Ral 6019 | | Ral 7035 | Ral 7037 | Ral 7042 | | Ral 7016 | Ral 9006 | Negro/Black/ Noir | | <table border="1"> <tr> <td>Blanco/White/ Blanc</td> <td>Negro/Black/ Noir</td> <td>Ral 7016</td> </tr> </table> | | | Blanco/White/ Blanc | Negro/Black/ Noir | Ral 7016 |    | | |
| Blanco/White/ Blanc | Ral 1015 | Ral 1018 | | | | | | | | | | | | | | | | | | | | | | | | | | | | | | | | | | | |
| Ral 2003 | Ral 3003 | Ral 3020 | | | | | | | | | | | | | | | | | | | | | | | | | | | | | | | | | | | |
| Ral 5015 | Ral 5017 | Ral 5011 | | | | | | | | | | | | | | | | | | | | | | | | | | | | | | | | | | | |
| Ral 6002 | Ral 6018 | Ral 6019 | | | | | | | | | | | | | | | | | | | | | | | | | | | | | | | | | | | |
| Ral 7035 | Ral 7037 | Ral 7042 | | | | | | | | | | | | | | | | | | | | | | | | | | | | | | | | | | | |
| Ral 7016 | Ral 9006 | Negro/Black/ Noir | | | | | | | | | | | | | | | | | | | | | | | | | | | | | | | | | | | |
| Blanco/White/ Blanc | Negro/Black/ Noir | Ral 7016 | | | | | | | | | | | | | | | | | | | | | | | | | | | | | | | | | | | |
| Opciones pág. 426-427 Options pages 426-427 Options pages 426-427 | | | | | No Incluidos / Not includes / Non inclus | | | Lateral Espejo Mirror end panels Joue Miroir Lat. Panorámico Panoramic end panels Joue panoramique Lateral Display Display end panels Joue Display | | | | | | | | | | | | | | | | | | | | | | | | | | | | | |

Serie / Series / Série **MDG (PORTLAND)**

+Info: www.infrico.com

ML25DG H1



**Nuevo
paragolpes
frontal**

**New
front
bumper**

**Nouveau
pare-chocs
frontale**



ML25DG M2

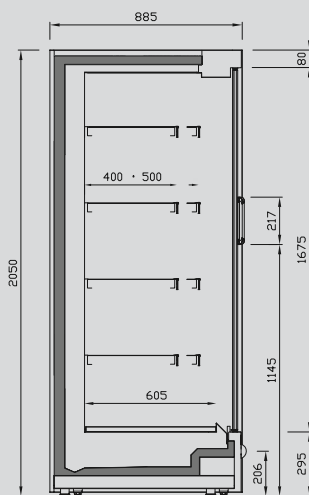

ML DG M0/M1/M2

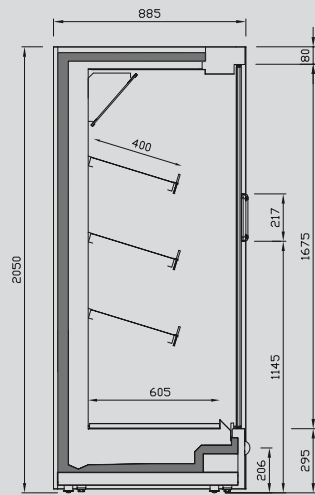

ML DG H1











Mural remota de refrigeración cerradas

Remote refrigeration doors multideck

Murales de réfrigération fermée groupe à distance



| MODELO MODELE MODÈLE |  |  |  |  |  | | | | | | | | | | | | | | | | | | | | | | | | | | | | | | | | |
|---|---|---|---|---|---|-----------------------------|----------------------|---|----------------------|----------------------|----------------------|--|----------|----------|----------|--|----------|----------|----------|--|----------|----------|----------|--|----------|----------|----------------------|--|--|--|--|------------------------|----------------------|----------|---|--|--|
| Precio Price Prix | M0 | 4.144 € | 5.548 € | 6.601 € | 7.714 € | 8.842 € | | | | | | | | | | | | | | | | | | | | | | | | | | | | | | | |
| MOD. | ML12 DG22 M1 | ML18 DG22 M1 | ML25 DG22 M1 | ML31 DG22 M1 | ML37 DG22 M1 | | | | | | | | | | | | | | | | | | | | | | | | | | | | | | | | |
| Precio Price Prix | M1 | 4.144 € | 5.548 € | 6.601 € | 7.714 € | 8.842 € | | | | | | | | | | | | | | | | | | | | | | | | | | | | | | | |
| MOD. | ML12 DG22 M2 | ML18 DG22 M2 | ML25 DG22 M2 | ML31 DG22 M2 | ML37 DG22 M2 | | | | | | | | | | | | | | | | | | | | | | | | | | | | | | | | |
| Precio Price Prix | M2 | 4.144 € | 5.548 € | 6.601 € | 7.714 € | 8.842 € | | | | | | | | | | | | | | | | | | | | | | | | | | | | | | | |
| MOD. | ML12 DG22 H1 | ML18 DG22 H1 | ML25 DG22 H1 | ML31 DG22 H1 | ML37 DG22 H1 | | | | | | | | | | | | | | | | | | | | | | | | | | | | | | | | |
| Precio Price Prix | H1 | 4.182 € | 5.652 € | 6.726 € | 7.861 € | 8.927 € | | | | | | | | | | | | | | | | | | | | | | | | | | | | | | | |
| Medidas / Mesures / Mesures / [mm] Sin costados / Without sides / Sans joues | | 1250 x 885 x 2200 mm. | 1875 x 885 x 2200 mm. | 2500 x 885 x 2200 mm. | 3125 x 885 x 2200 mm. | 3750 x 885 x 2200 mm. | | | | | | | | | | | | | | | | | | | | | | | | | | | | | | | |
| T°. Prod. Aplic. Prod. T°. Applic. T°. (°C) Temp. Prod. Temp. Appliq. | | M0: -1/+4°C -1/+1°C M1: -1/+5°C 0/+2°C M2: -1/+7°C +2/+4°C H1: +1/+10°C +4/+6°C | | | | | | | | | | | | | | | | | | | | | | | | | | | | | | | | | | | |
| Clase Climática Climatic class Classe climatique (°C) | | 3 / 25°C | | | | | | | | | | | | | | | | | | | | | | | | | | | | | | | | | | | |
| Tensión/Frecuencia Electrical data Tension électrique | | 230V/1ph/50Hz | | | | | | | | | | | | | | | | | | | | | | | | | | | | | | | | | | | |
| Controlador Controller Régulateur | | Digital | | | | | | | | | | | | | | | | | | | | | | | | | | | | | | | | | | | |
| Material Material Matériel (EXT/INT) | | Acero galvanizado plastificado / Plastified galvanised steel / Acier galvanisé plastifié | | | | | | | | | | | | | | | | | | | | | | | | | | | | | | | | | | | |
| Aislamiento Isolation Isolation [mm] | | 40kg/m ³ / Free CFC's / Zero ODP-GWP | | | | | | | | | | | | | | | | | | | | | | | | | | | | | | | | | | | |
| Capacidad Capacity Capacité [L] | | 849 | 1273 | 1698 | 2122 | 2546 | | | | | | | | | | | | | | | | | | | | | | | | | | | | | | | |
| Superficie exposición Surface exhibition [x m ²] Surface d'exposition | | 3,26 | 4,88 | 6,51 | 8,14 | 9,7 | | | | | | | | | | | | | | | | | | | | | | | | | | | | | | | |
| Niveles Exposición Exposition Levels Niveaux d'exposition | | M0, M1, M2: 5+Expos. H1: 4+Expos. | | | | | | | | | | | | | | | | | | | | | | | | | | | | | | | | | | | |
| Costados (2) Sides (2) Joues (2) [mm] | | 40 + 40 | | | | | | | | | | | | | | | | | | | | | | | | | | | | | | | | | | | |
| Puertas Doors Portes | | 2 | 3 | 4 | 5 | 6 | | | | | | | | | | | | | | | | | | | | | | | | | | | | | | | |
| Sistema de frío Cooling System Système de froid | | Ventilado / Ventilated / Ventilé | | | | | | | | | | | | | | | | | | | | | | | | | | | | | | | | | | | |
| Desescarche Defrost Dégivrage | | Automático / Automatic / Automatique | | | | | | | | | | | | | | | | | | | | | | | | | | | | | | | | | | | |
| Evaporación Evaporation Évaporation | | Forzada / Forced / Ventilé | | | | | | | | | | | | | | | | | | | | | | | | | | | | | | | | | | | |
| Potencia Power Puissance [W] | | - | | | | | | | | | | | | | | | | | | | | | | | | | | | | | | | | | | | |
| Potencia frig. Cooling capacity Puissance Frig. [W A -10°C] | | M0: 1018 M2: 815 | M1: 928 H1: 683 | M0: 1596 M2: 1223 | M1: 1391 H1: 1024 | M0: 2035 M2: 1630 | M1: 1855 H1: 1365 | M0: 2544 M2: 2041 | M1: 2319 H1: 1706 | M0: 3053 M2: 2445 | M1: 2783 H1: 2048 | | | | | | | | | | | | | | | | | | | | | | | | | | |
| Consumo Consumption Consommation [kWh/ 24h] | | - | | | | | | | | | | | | | | | | | | | | | | | | | | | | | | | | | | | |
| Refrigerante Refrigerant Gaz | | FREON | | | | | | | | | | | | | | | | | | | | | | | | | | | | | | | | | | | |
| Colores estándar Standard colors Couleurs standard | | Ext. Estándar / Standar / Standard | | | Int. Estándar / Standar / Standard | | | | | | | | | | | | | | | | | | | | | | | | | | | | | | | | |
| Laterales disponibles Available sides Joues disponibles | | <table border="1"> <tr> <td>Blanco/White/ Blanc</td> <td>Ral 1015</td> <td>Ral 1018</td> <td></td> </tr> <tr> <td>Ral 2003</td> <td>Ral 3003</td> <td>Ral 3020</td> <td></td> </tr> <tr> <td>Ral 5015</td> <td>Ral 5017</td> <td>Ral 5011</td> <td></td> </tr> <tr> <td>Ral 6002</td> <td>Ral 6018</td> <td>Ral 6019</td> <td></td> </tr> <tr> <td>Ral 7035</td> <td>Ral 7037</td> <td>Ral 7042</td> <td></td> </tr> <tr> <td>Ral 7016</td> <td>Ral 9006</td> <td>Negro/Black/ Noir</td> <td></td> </tr> </table> | | | Blanco/White/ Blanc | Ral 1015 | Ral 1018 | | Ral 2003 | Ral 3003 | Ral 3020 | | Ral 5015 | Ral 5017 | Ral 5011 | | Ral 6002 | Ral 6018 | Ral 6019 | | Ral 7035 | Ral 7037 | Ral 7042 | | Ral 7016 | Ral 9006 | Negro/Black/ Noir | | <table border="1"> <tr> <td>Blanco/White/ Blanc</td> <td>Negro/Black/ Noir</td> <td>Ral 7016</td> </tr> </table> | | | Blanco/White/ Blanc | Negro/Black/ Noir | Ral 7016 |    | | |
| Blanco/White/ Blanc | Ral 1015 | Ral 1018 | | | | | | | | | | | | | | | | | | | | | | | | | | | | | | | | | | | |
| Ral 2003 | Ral 3003 | Ral 3020 | | | | | | | | | | | | | | | | | | | | | | | | | | | | | | | | | | | |
| Ral 5015 | Ral 5017 | Ral 5011 | | | | | | | | | | | | | | | | | | | | | | | | | | | | | | | | | | | |
| Ral 6002 | Ral 6018 | Ral 6019 | | | | | | | | | | | | | | | | | | | | | | | | | | | | | | | | | | | |
| Ral 7035 | Ral 7037 | Ral 7042 | | | | | | | | | | | | | | | | | | | | | | | | | | | | | | | | | | | |
| Ral 7016 | Ral 9006 | Negro/Black/ Noir | | | | | | | | | | | | | | | | | | | | | | | | | | | | | | | | | | | |
| Blanco/White/ Blanc | Negro/Black/ Noir | Ral 7016 | | | | | | | | | | | | | | | | | | | | | | | | | | | | | | | | | | | |
| Opciones pág. 426-427 Options pages 426-427 Options pages 426-427 | | | | | <p>No Incluidos / Not includes / Non inlues</p> | | | <p>Lateral Espejo Mirror end panels Joue Miroir</p> <p>Lat. Panorámico Panoramic end panels Joue panoramique</p> <p>Lateral Display Display end panels Joue Display</p> | | | | | | | | | | | | | | | | | | | | | | | | | | | | | |

Serie / Series / Série **MDG (PORTLAND)**

+Info: www.infrico.com



ML37DG22 M2



Nuevo paragolpes frontal

New front bumper

Nouveau pare-chocs frontale



ML37DG22 M2

Lateral panorámico
Panoramic side panel
Joue panoramique

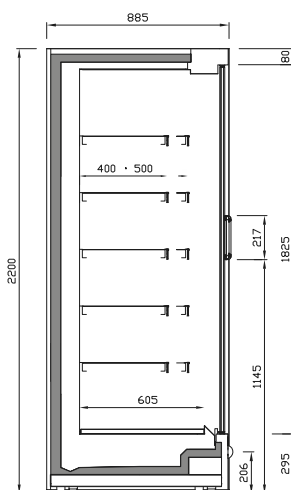

ML DG22 MO/M1/M2

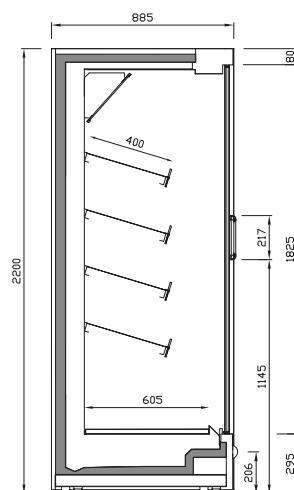

ML DG22 H1











Mural remota de refrigeración cerradas

Remote refrigeration doors multideck

Murales de réfrigération fermée groupe à distance



| MODELO MODELE MODÈLE |  |  |  |  |  | | | | | | | | | | | | | | | | | | | | | | | | | | | | | | | | |
|---|---|---|---|---|---|------------------------------|----------------------|--|----------------------|----------------------|--|--|----------|----------|----------|--|----------|----------|----------|--|----------|----------|----------|--|----------|----------|----------------------|--|--|--|--|------------------------|----------------------|----------|---|--|--|
| Precio Price Prix | M0 | 4.215 € | 5.646 € | 6.719 € | 7.853 € | 9.002 € | | | | | | | | | | | | | | | | | | | | | | | | | | | | | | | |
| MOD. | MX12 DG M1 | MX18 DG M1 | MX25 DG M1 | MX31 DG M1 | MX37 DG M1 | | | | | | | | | | | | | | | | | | | | | | | | | | | | | | | | |
| Precio Price Prix | M1 | 4.215 € | 5.646 € | 6.719 € | 7.853 € | 9.002 € | | | | | | | | | | | | | | | | | | | | | | | | | | | | | | | |
| MOD. | MX12 DG M2 | MX18 DG M2 | MX25 DG M2 | MX31 DG M2 | MX37 DG M2 | | | | | | | | | | | | | | | | | | | | | | | | | | | | | | | | |
| Precio Price Prix | M2 | 4.215 € | 5.646 € | 6.719 € | 7.853 € | 9.002 € | | | | | | | | | | | | | | | | | | | | | | | | | | | | | | | |
| MOD. | MX12 DG H1 | MX18 DG H1 | MX25 DG H1 | MX31 DG H1 | MX37 DG H1 | | | | | | | | | | | | | | | | | | | | | | | | | | | | | | | | |
| Precio Price Prix | H1 | 4.254 € | 5.698 € | 6.846 € | 7.853 € | 9.174 € | | | | | | | | | | | | | | | | | | | | | | | | | | | | | | | |
| Medidas / Measures / Mesures / [mm] Sin costados / Without sides / Sans joues | | 1250 x 1085 x 2050 mm. | 1875 x 1085 x 2050 mm. | 2500 x 1085 x 2050 mm. | 3125 x 1085 x 2050 mm. | 3750 x 1085 x 2050 mm. | | | | | | | | | | | | | | | | | | | | | | | | | | | | | | | |
| T°. Prod. Aplic. Prod. T°. Applic. T°. [°C] Temp. Prod. Temp. Appliq. | | M0: -1/+4°C -1/+1°C | | M1: -1/+5°C 0/+2°C | | M2: -1/+7°C +2/+4°C | | H1: +1/+10°C +4/+6°C | | | | | | | | | | | | | | | | | | | | | | | | | | | | | |
| Clase Climática Climatic class [°C] Classe climatique | | 3 / 25°C | | | | | | | | | | | | | | | | | | | | | | | | | | | | | | | | | | | |
| Tensión/Frecuencia Electrical data Tension électrique | | 230V/1ph/50Hz | | | | | | | | | | | | | | | | | | | | | | | | | | | | | | | | | | | |
| Controlador Controller Régulateur | | Digital | | | | | | | | | | | | | | | | | | | | | | | | | | | | | | | | | | | |
| Material Material Matériel [EXT/INT] | | Acero galvanizado plastificado / Plastified galvanised steel / Acier galvanisé plastifié | | | | | | | | | | | | | | | | | | | | | | | | | | | | | | | | | | | |
| Aislamiento Isolation Isolation [mm] | | 40kg/m ³ / Free CFC's / Zero ODP-GWP | | | | | | | | | | | | | | | | | | | | | | | | | | | | | | | | | | | |
| Capacidad Capacity Capacité [L] | | M0, M1, M2: 1166 H1: 985 | M0, M1, M2: 1749 H1: 1478 | M0, M1, M2: 2333 H1: 1970 | M0, M1, M2: 2916 H1: 2463 | M0, M1, M2: 3499 H1: 2955 | | | | | | | | | | | | | | | | | | | | | | | | | | | | | | | |
| Superficie exposición Surface exhibition [x m ²] Surface d'exposition | | M0, M1, M2: 4,01 H1: 3,26 | M0, M1, M2: 6,02 H1: 4,90 | M0, M1, M2: 8,10 H1: 6,50 | M0, M1, M2: 10,1 H1: 8,10 | M0, M1, M2: 12,0 H1: 9,80 | | | | | | | | | | | | | | | | | | | | | | | | | | | | | | | |
| Niveles Exposición Exposition Levels Niveaux d'exposition | | M0, M1, M2: 4+Expos. H1: 3+Expos. | | | | | | | | | | | | | | | | | | | | | | | | | | | | | | | | | | | |
| Costados [2] Sides [2] Joues [2] [mm] | | 40 + 40 | | | | | | | | | | | | | | | | | | | | | | | | | | | | | | | | | | | |
| Puertas Doors Portes | | 2 | 3 | 4 | 5 | 6 | | | | | | | | | | | | | | | | | | | | | | | | | | | | | | | |
| Sistema de frío Cooling System Système de froid | | Ventilado / Ventilated / Ventilé | | | | | | | | | | | | | | | | | | | | | | | | | | | | | | | | | | | |
| Desescarche Defrost Dégivrage | | Automático / Automatic / Automatique | | | | | | | | | | | | | | | | | | | | | | | | | | | | | | | | | | | |
| Evaporación Evaporation Évaporation | | Forzada / Forced / Ventilé | | | | | | | | | | | | | | | | | | | | | | | | | | | | | | | | | | | |
| Potencia Power Puissance [W] | | - | | | | | | | | | | | | | | | | | | | | | | | | | | | | | | | | | | | |
| Potencia frig. Cooling capacity Puissance Frig. [W A -10°C] | | M0: 986 M2: 773 | M1: 895 H1: 638 | M0: 1479 M2: 1159 | M1: 1343 H1: 956 | M0: 1973 M2: 1545 | M1: 1790 H1: 1275 | M0: 2466 M2: 1931 | M1: 2238 H1: 1594 | M0: 2959 M2: 2318 | M1: 2685 H1: 1913 | | | | | | | | | | | | | | | | | | | | | | | | | | |
| Consumo Consumption Consommation [kWh/ 24h] | | - | | | | | | | | | | | | | | | | | | | | | | | | | | | | | | | | | | | |
| Refrigerante Refrigerant Gaz | | FREON | | | | | | | | | | | | | | | | | | | | | | | | | | | | | | | | | | | |
| Colores estándar Standard colors Couleurs standard | | Ext. Estándar / Standar / Standard | | | Int. Estándar / Standar / Standard | | | | | | | | | | | | | | | | | | | | | | | | | | | | | | | | |
| Laterales disponibles Available sides Joues disponibles | | <table border="1"> <tr> <td>Blanco/White/ Blanc</td> <td>Ral 1015</td> <td colspan="2">Ral 1018</td> </tr> <tr> <td>Ral 2003</td> <td>Ral 3003</td> <td colspan="2">Ral 3020</td> </tr> <tr> <td>Ral 5015</td> <td>Ral 5017</td> <td colspan="2">Ral 5011</td> </tr> <tr> <td>Ral 6002</td> <td>Ral 6018</td> <td colspan="2">Ral 6019</td> </tr> <tr> <td>Ral 7035</td> <td>Ral 7037</td> <td colspan="2">Ral 7042</td> </tr> <tr> <td>Ral 7016</td> <td>Ral 9006</td> <td colspan="2">Negro/Black/ Noir</td> </tr> </table> | | | Blanco/White/ Blanc | Ral 1015 | Ral 1018 | | Ral 2003 | Ral 3003 | Ral 3020 | | Ral 5015 | Ral 5017 | Ral 5011 | | Ral 6002 | Ral 6018 | Ral 6019 | | Ral 7035 | Ral 7037 | Ral 7042 | | Ral 7016 | Ral 9006 | Negro/Black/ Noir | | <table border="1"> <tr> <td>Blanco/White/ Blanc</td> <td>Negro/Black/ Noir</td> <td>Ral 7016</td> </tr> </table> | | | Blanco/White/ Blanc | Negro/Black/ Noir | Ral 7016 |    | | |
| Blanco/White/ Blanc | Ral 1015 | Ral 1018 | | | | | | | | | | | | | | | | | | | | | | | | | | | | | | | | | | | |
| Ral 2003 | Ral 3003 | Ral 3020 | | | | | | | | | | | | | | | | | | | | | | | | | | | | | | | | | | | |
| Ral 5015 | Ral 5017 | Ral 5011 | | | | | | | | | | | | | | | | | | | | | | | | | | | | | | | | | | | |
| Ral 6002 | Ral 6018 | Ral 6019 | | | | | | | | | | | | | | | | | | | | | | | | | | | | | | | | | | | |
| Ral 7035 | Ral 7037 | Ral 7042 | | | | | | | | | | | | | | | | | | | | | | | | | | | | | | | | | | | |
| Ral 7016 | Ral 9006 | Negro/Black/ Noir | | | | | | | | | | | | | | | | | | | | | | | | | | | | | | | | | | | |
| Blanco/White/ Blanc | Negro/Black/ Noir | Ral 7016 | | | | | | | | | | | | | | | | | | | | | | | | | | | | | | | | | | | |
| Opciones pág. 426-427 Options pages 426-427 Options pages 426-427 | | <p>No Incluidos / Not includes / Non inclus</p> | | | <p>Lateral Espejo Mirror end panels Joue Miroir</p> | | | <p>Lat. Panorámico Panoramic end panels Joue panoramique</p> | | | <p>Lateral Display Display end panels Joue Display</p> | | | | | | | | | | | | | | | | | | | | | | | | | | |

Serie / Series / Série **MDG (PORTLAND)**

+Info: www.infrico.com

MX25DG H1



MX37DG M2

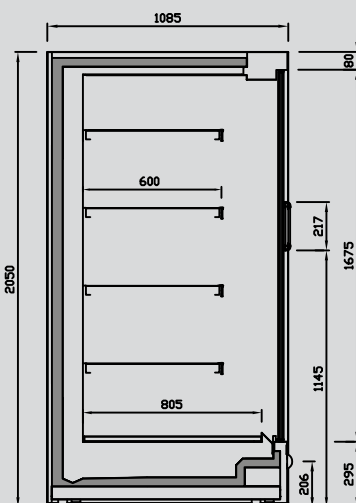

MX DG M0/M1/M2

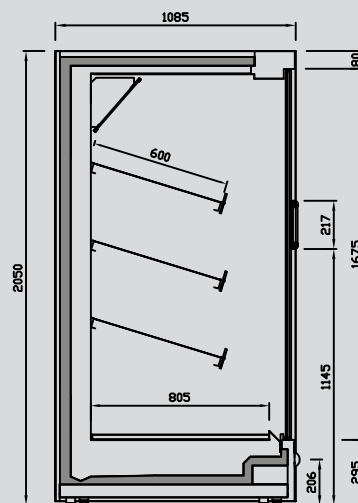

MX DG H1











Mural remota de refrigeración cerradas

Remote refrigeration doors multideck

Murales de réfrigération fermée groupe à distance



| MODELO MODELE MODÈLE |  |  |  |  |  | | | | | | | | | | | | | | | | | | | | | | | | | | | | | | | | |
|---|---|---|---|---|---|------------------------------|----------------------|-------------------------------|----------------------|----------------------|----------------------|--|----------|----------|----------|--|----------|----------|----------|--|----------|----------|----------|--|----------|----------|----------------------|--|--|--|--|------------------------|----------------------|----------|---|--|--|
| Precio Price Prix | M0 | 4.446 € | 5.909 € | 7.100 € | 8.227 € | 9.519 € | | | | | | | | | | | | | | | | | | | | | | | | | | | | | | | |
| MOD. | MX12 DG22 M1 | MX18 DG22 M1 | MX25 DG22 M1 | MX31 DG22 M1 | MX37 DG22 M1 | | | | | | | | | | | | | | | | | | | | | | | | | | | | | | | | |
| Precio Price Prix | M1 | 4.446 € | 5.909 € | 7.100 € | 8.227 € | 9.519 € | | | | | | | | | | | | | | | | | | | | | | | | | | | | | | | |
| MOD. | MX12 DG22 M2 | MX18 DG22 M2 | MX25 DG22 M2 | MX31 DG22 M2 | MX37 DG22 M2 | | | | | | | | | | | | | | | | | | | | | | | | | | | | | | | | |
| Precio Price Prix | M2 | 4.446 € | 5.909 € | 7.100 € | 8.227 € | 9.519 € | | | | | | | | | | | | | | | | | | | | | | | | | | | | | | | |
| MOD. | MX12 DG22 H1 | MX18 DG22 H1 | MX25 DG22 H1 | MX31 DG22 H1 | MX37 DG22 H1 | | | | | | | | | | | | | | | | | | | | | | | | | | | | | | | | |
| Precio Price Prix | H1 | 4.446 € | 5.965 € | 7.235 € | 8.306 € | 9.702 € | | | | | | | | | | | | | | | | | | | | | | | | | | | | | | | |
| Medidas / Measures / Mesures / [mm] Sin costados / Without sides / Sans joues | | 1250 x 1085 x 2200 mm. | 1875 x 1085 x 2200 mm. | 2500 x 1085 x 2200 mm. | 3125 x 1085 x 2200 mm. | 3750 x 1085 x 2200 mm. | | | | | | | | | | | | | | | | | | | | | | | | | | | | | | | |
| T°. Prod. Aplic. Prod. T°. Applic. T°. [°C] Temp. Prod. Temp. Appliq. | | M0: -1/+4°C -1/+1°C | | M1: -1/+5°C 0/+2°C | | M2: -1/+7°C +2/+4°C | | H1: +1/+10°C +4/+6°C | | | | | | | | | | | | | | | | | | | | | | | | | | | | | |
| Clase Climática Climatic class [°C] Classe climatique | | 3 / 25°C | | | | | | | | | | | | | | | | | | | | | | | | | | | | | | | | | | | |
| Tensión/Frecuencia Electrical data Tension électrique | | 230V/1ph/50Hz | | | | | | | | | | | | | | | | | | | | | | | | | | | | | | | | | | | |
| Controlador Controller Régulateur | | Digital | | | | | | | | | | | | | | | | | | | | | | | | | | | | | | | | | | | |
| Material Material [EXT/INT] Matériel | | Acero galvanizado plastificado / Plastified galvanised steel / Acier galvanisé plastifié | | | | | | | | | | | | | | | | | | | | | | | | | | | | | | | | | | | |
| Aislamiento Isolation [mm] Isolation | | 40kg/m ³ / Free CFC's / Zero ODP-GWP | | | | | | | | | | | | | | | | | | | | | | | | | | | | | | | | | | | |
| Capacidad Capacity [L] Capacité | | M0, M1, M2: 951 H1: 801 | M0, M1, M2: 1427 H1: 1202 | M0, M1, M2: 1903 H1: 1601 | M0, M1, M2: 2378 H1: 2003 | M0, M1, M2: 2854 H1: 2404 | | | | | | | | | | | | | | | | | | | | | | | | | | | | | | | |
| Superficie exposición Surface exhibition [x m ²] Surface d'exposition | | M0, M1, M2: 4,76 H1: 4,01 | M0, M1, M2: 7,10 H1: 6,10 | M0, M1, M2: 9,50 H1: 8,10 | M0, M1, M2: 11,9 H1: 10,1 | M0, M1, M2: 14,3 H1: 12,1 | | | | | | | | | | | | | | | | | | | | | | | | | | | | | | | |
| Niveles Exposición Exposition Levels Niveaux d'exposition | | M0, M1, M2: 5+Expos. H1: 4+Expos. | | | | | | | | | | | | | | | | | | | | | | | | | | | | | | | | | | | |
| Costados [2] Sides [2] [mm] Joues [2] | | 40 + 40 | | | | | | | | | | | | | | | | | | | | | | | | | | | | | | | | | | | |
| Puertas Doors Portes | | 2 | 3 | 4 | 5 | 6 | | | | | | | | | | | | | | | | | | | | | | | | | | | | | | | |
| Sistema de frío Cooling System Système de froid | | Ventilado / Ventilated / Ventilé | | | | | | | | | | | | | | | | | | | | | | | | | | | | | | | | | | | |
| Desescarche Defrost Dégivrage | | Automático / Automatic / Automatique | | | | | | | | | | | | | | | | | | | | | | | | | | | | | | | | | | | |
| Evaporación Evaporation Évaporation | | Forzada / Forced / Ventilé | | | | | | | | | | | | | | | | | | | | | | | | | | | | | | | | | | | |
| Potencia Power [W] Puissance | | - | | | | | | | | | | | | | | | | | | | | | | | | | | | | | | | | | | | |
| Potencia frig. Cooling capacity Puissance Frig. [W A -10°C] | | M0: 1018 M2: 816 | M1: 928 H1: 683 | M0: 1596 M2: 1224 | M1: 1391 H1: 1024 | M0: 2035 M2: 1633 | M1: 1855 H1: 1365 | M0: 2544 M2: 2041 | M1: 2319 H1: 1706 | M0: 3053 M2: 2449 | M1: 2783 H1: 2048 | | | | | | | | | | | | | | | | | | | | | | | | | | |
| Consumo Consumption [kWh/ 24h] Consommation | | - | | | | | | | | | | | | | | | | | | | | | | | | | | | | | | | | | | | |
| Refrigerante Refrigerant Gaz | | FREON | | | | | | | | | | | | | | | | | | | | | | | | | | | | | | | | | | | |
| Colores estándar Standard colors Couleurs standard | | Ext. Estándar / Standar / Standard | | | Int. Estándar / Standar / Standard | | | | | | | | | | | | | | | | | | | | | | | | | | | | | | | | |
| Laterales disponibles Available sides Joues disponibles | | <table border="1"> <tr> <td>Blanco/White/ Blanc</td> <td>Ral 1015</td> <td>Ral 1018</td> <td></td> </tr> <tr> <td>Ral 2003</td> <td>Ral 3003</td> <td>Ral 3020</td> <td></td> </tr> <tr> <td>Ral 5015</td> <td>Ral 5017</td> <td>Ral 5011</td> <td></td> </tr> <tr> <td>Ral 6002</td> <td>Ral 6018</td> <td>Ral 6019</td> <td></td> </tr> <tr> <td>Ral 7035</td> <td>Ral 7037</td> <td>Ral 7042</td> <td></td> </tr> <tr> <td>Ral 7016</td> <td>Ral 9006</td> <td>Negro/Black/ Noir</td> <td></td> </tr> </table> | | | Blanco/White/ Blanc | Ral 1015 | Ral 1018 | | Ral 2003 | Ral 3003 | Ral 3020 | | Ral 5015 | Ral 5017 | Ral 5011 | | Ral 6002 | Ral 6018 | Ral 6019 | | Ral 7035 | Ral 7037 | Ral 7042 | | Ral 7016 | Ral 9006 | Negro/Black/ Noir | | <table border="1"> <tr> <td>Blanco/White/ Blanc</td> <td>Negro/Black/ Noir</td> <td>Ral 7016</td> </tr> </table> | | | Blanco/White/ Blanc | Negro/Black/ Noir | Ral 7016 |    | | |
| Blanco/White/ Blanc | Ral 1015 | Ral 1018 | | | | | | | | | | | | | | | | | | | | | | | | | | | | | | | | | | | |
| Ral 2003 | Ral 3003 | Ral 3020 | | | | | | | | | | | | | | | | | | | | | | | | | | | | | | | | | | | |
| Ral 5015 | Ral 5017 | Ral 5011 | | | | | | | | | | | | | | | | | | | | | | | | | | | | | | | | | | | |
| Ral 6002 | Ral 6018 | Ral 6019 | | | | | | | | | | | | | | | | | | | | | | | | | | | | | | | | | | | |
| Ral 7035 | Ral 7037 | Ral 7042 | | | | | | | | | | | | | | | | | | | | | | | | | | | | | | | | | | | |
| Ral 7016 | Ral 9006 | Negro/Black/ Noir | | | | | | | | | | | | | | | | | | | | | | | | | | | | | | | | | | | |
| Blanco/White/ Blanc | Negro/Black/ Noir | Ral 7016 | | | | | | | | | | | | | | | | | | | | | | | | | | | | | | | | | | | |
| Opciones pág. 426-427 Options pages 426-427 Options pages 426-427 | | <p>No Incluidos / Not includes / Non includes</p> | | | <p>Lateral Espejo Mirror end panels Joue Miroir</p> <p>Lat. Panorámico Panoramic end panels Joue panoramique</p> <p>Lateral Display Display end panels Joue Display</p> | | | | | | | | | | | | | | | | | | | | | | | | | | | | | | | | |

Serie / Series / Série **MDG (PORTLAND)**

+Info: www.infrico.com



MX37DG22 M2



**Nuevo
paragolpes
frontal**

**New
front
bumper**

**Nouveau
pare-chocs
frontale**



MX37DG22 H1

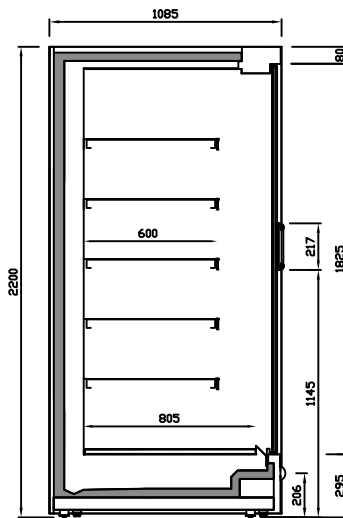

MX DG22 M0/M1/M2

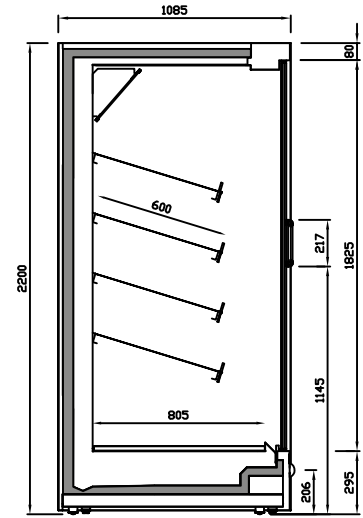

MX DG22 H1



Las fotografías que están en estas páginas son fotografías que se actualizan periódicamente en función de las necesidades del punto de venta. Los datos que se muestran en estas páginas son solo orientativos y pueden estar sujetos a modificaciones sin previo aviso. Las fotografías que están en estas páginas son fotografías que se actualizan periódicamente en función de las necesidades del punto de venta. Los datos que se muestran en estas páginas son solo orientativos y pueden estar sujetos a modificaciones sin previo aviso.

Murales Mixtas de refrigeración cerradas

Mixed refrigeration doors multideck

Murales mixtes fermées groupe à distance

| MODELO MODELE MODÈLE | | | | | | |
|---|--|-------------------------------|----------------------------------|--|--------------------------------|--|
| Precio Price Prix | M1 | 3.932 € | 5.145 € | 6.257 € | 9.074 € | |
| MOD. | MS12 DGU M2 | MS18 DGU M2 | MS25 DGU M2 | MS37 DGU M2 | | |
| Precio Price Prix | M2 | 3.932 € | 5.145 € | 6.257 € | 9.074 € | |
| MOD. | MS12 DGU H1 | MS18 DGU H1 | MS25 DGU H1 | MS37 DGU H1 | | |
| Precio Price Prix | H1 | 4.011 € | 5.248 € | 6.382 € | 9.256 € | |
| Medidas / Measures / Mesuras / [mm] | | 1250 x 680 x 2050 mm. | 1875 x 680 x 2050 mm. | 2500 x 680 x 2050 mm. | 3750 x 680 x 2050 mm. | |
| Sin costados / Without sides / Sans joues | | | | | | |
| T°. Prod. Aplic. Prod. T°. Applic. T°. [°C] Temp. Prod. Temp. Appliq. | M1: -1/+5°C 0/+2°C M2: -1/+7°C +2/+4°C H1: +1/+10°C +4/+6°C | | | | | |
| Clase Climática Climatic class Classe climatique [°C] | 3 / 25°C | | | | | |
| Tensión/Frecuencia Electrical data Tension électrique | 230V/1ph/50Hz | | | | | |
| Controlador Controller Régulateur | Digital | | | | | |
| Material Material Matériel [EXT/INT] | Acero galvanizado plastificado / Plastified galvanised steel / Acier galvanisé plastifié | | | | | |
| Aislamiento Isolation Isolation [mm] | 40kg/m ³ / Free CFC's / Zero ODP-GWP | | | | | |
| Capacidad Capacity Capacité [L] | | M1, M2: 401 H1: 326 | M1, M2: 602 H1: 489 | M1, M2: 803 H1: 653 | M1, M2: 1204 H1: 979 | |
| Superficie exposición Surface exhibition Surface d'exposition [x m ²] | | M1, M2: 2,01 H1: 1,64 | M1, M2: 3,02 H1: 2,46 | M1, M2: 4,02 H1: 3,27 | M1, M2: 6,04 H1: 4,91 | |
| Niveles Exposición Exposition Levels Niveaux d'exposition | M1, M2: 4+Expos. H1: 3+Expos. | | | | | |
| Costados [2] Sides [2] Joues [2] [mm] | 40 + 40 | | | | | |
| Puertas Doors Portes | | 2 | 3 | 4 | 6 | |
| Sistema de frío Cooling System Système de froid | Ventilado / Ventilated / Ventilé | | | | | |
| Desescarche Defrost Dégivrage | Automático / Automatic / Automatique | | | | | |
| Evaporación Evaporation Évaporation | Forzada / Forced / Ventilé | | | | | |
| Potencia Power Puissance [W] | | M1: 665 M2: 665 H1: 665 | M1: 772 M2: 772 H1: 772 | M1: 1147 M2: 1147 H1: 1147 | M1: 2270 M2: 2270 H1: 2270 | |
| Potencia frig. Cooling capacity Puissance Frig. [W A -10°C] | - | | | | | |
| Consumo Consumption Consommation [kWh/ 24h] | | M1: 11.7 M2: 10.9 H1: 10.4 | M1: 13.1 M2: 12.6 H1: 12.0 | M1: 19.8 M2: 18.7 H1: 17.8 | M1: 38.1 M2: 37.1 H1: 35.41 | |
| Refrigerante Refrigerant Gaz | R290 | | | | | |
| Colores estándar Standar colors Couleurs standard | Int. Estándar / Standar / Standard | | Laterales / Sides / Joues | | | |
| | Blanco/White/ Blanc | Negro/Black/ Noir | Ral 7016 | No Incluidos / Not includes / Non inclus | | |
| Laterales disponibles Available sides Joues disponibles | Ext. Estándar / Standar / Standard | | | | | |
| | Blanco/White/ Blanc | Ral 1015 | Ral 1018 | | | |
| Opciones pág. 426-427 Options pages 426-427 Options pages 426-427 | Ral 2003 | Ral 3003 | Ral 3020 | | | |
| | Ral 5015 | Ral 5017 | Ral 5011 | | | |
| | Ral 6002 | Ral 6018 | Ral 6019 | | | |
| | Ral 7035 | Ral 7037 | Ral 7042 | | | |
| | Ral 7016 | Ral 9006 | Negro/Black/ Noir | | | |
| | | | | | | |

Serie / Series / Série **MDGU (DETROIT)**

+Info: www.infrico.com



MS37DGU M2



**Nuevo
paragolpes
frontal**

**New
front
bumper**

**Nouveau
pare-chocs
frontale**



MS25DGU H1

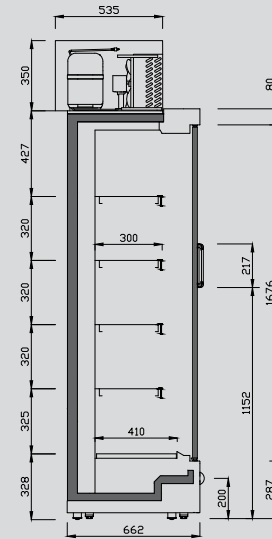

MS DGU M1/M2

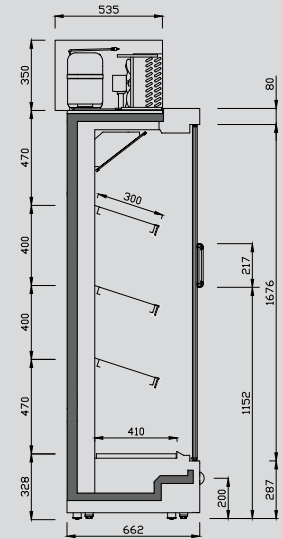

MS DGU H1









Murales Mixtas de refrigeración cerradas

Mixed refrigeration doors multideck

Murales mixtes fermées groupe à distance



| MODELO MODELE MODÈLE |  |  |  |  | | |
|---|---|--|---|---|---|---|
| Precio Price Prix | M1 | 3.973 € | 5.145 € | 6.321 € | 9.168 € | |
| MOD. | MN12 DGU M2 | MN18 DGU M2 | MN25 DGU M2 | MN37 DGU M2 | | |
| Precio Price Prix | M2 | 3.973 € | 5.145 € | 6.321 € | 9.168 € | |
| MOD. | MN12 DGU H1 | MN18 DGU H1 | MN25 DGU H1 | MN37 DGU H1 | | |
| Precio Price Prix | H1 | 4.052 € | 5.248 € | 6.448 € | 9.350 € | |
| Medidas / Measures / Mesures / [mm] | | 1250 x 785 x 2050 mm. | 1875 x 785 x 2050 mm. | 2500 x 785 x 2050 mm. | 3750 x 785 x 2050 mm. | |
| Sin costados / Without sides / Sans joues | | | | | | |
| T°. Prod. Aplic. Prod. T°. Applic. T°. [°C] Temp. Prod. Temp. Appliq. | | M1: -1/+5°C 0/+2°C M2: -1/+7°C +2/+4°C H1: +1/+10°C +4/+6°C | | | | |
| Clase Climática Climatic class Classe climatique [°C] | | 3 / 25°C | | | | |
| Tensión/Frecuencia Electrical data Tension électrique | | 230V/1ph/50Hz | | | | |
| Controlador Controller Régulateur | | Digital | | | | |
| Material Material Matériel [EXT/INT] | | Acero galvanizado plastificado / Plastified galvanised steel / Acier galvanisé plastifié | | | | |
| Aislamiento Isolation Isolation [mm] | | 40kg/m ³ / Free CFC's / Zero ODP-GWP | | | | |
| Capacidad Capacity Capacité [L] | | M0, M1, M2: 766 H1: 655 | M0, M1, M2: 1149 H1: 983 | M0, M1, M2: 1533 H1: 1310 | M0, M1, M2: 2299 H1: 1965 | |
| Superficie exposición Surface exhibition Surface d'exposition [x m ²] | | M1, M2: 2,64 H1: 2,14 | M1, M2: 3,36 H1: 3,21 | M1, M2: 5,28 H1: 4,30 | M1, M2: 7,91 H1: 6,40 | |
| Niveles Exposición Exposition Levels Niveaux d'exposition | | M1, M2: 4+Expos. H1: 3+Expos. | | | | |
| Costados [2] Sides [2] Joues [2] [mm] | | 40 + 40 | | | | |
| Puertas Doors Portes | | 2 | 3 | 4 | 6 | |
| Sistema de frío Cooling System Système de froid | | Ventilado / Ventilated / Ventilé | | | | |
| Desescarche Defrost Dégivrage | | Automático / Automatic / Automatique | | | | |
| Evaporación Evaporation Évaporation | | Forzada / Forced / Ventilé | | | | |
| Potencia Power Puissance [W] | | M1: 746 M2: 721 H1: 721 | M1: 875 M2: 875 H1: 875 | M1: 1272 M2: 1272 H1: 1272 | M1: 2472 M2: 2472 H1: 2472 | |
| Potencia frig. Cooling capacity Puissance Frig. [W A -10°C] | | - | | | | |
| Consumo Consumption Consommation [kWh/ 24h] | | M1: 12,5 M2: 11,6 H1: 10,4 | M1: 14,7 M2: 13,6 H1: 12,2 | M1: 21,4 M2: 19,8 H1: 17,7 | M1: 35,6 M2: 32,6 H1: 29,7 | |
| Refrigerante Refrigerant Gaz | | R290 | | | | |
| Colores estándar Standar colors Couleurs standard | Int. Estándar / Standar / Standard | | Laterales / Sides / Joues | | | |
| | Blanco/White/ Blanc | Negro/Black/ Noir | Ral 7016 | No Incluidos / Not includes / Non inclus | | |
| Laterales disponibles Available sides Joues disponibles | Ext. Estándar / Standar / Standard | | | | | |
| | Blanco/White/ Blanc | Ral 1015 | Ral 1018 | | | |
| Opciones pág. 426-427 Options pages 426-427 Options pages 426-427 | Ral 2003 | Ral 3003 | Ral 3020 | | | |
| | Ral 5015 | Ral 5017 | Ral 5011 | | | |
| | Ral 6002 | Ral 6018 | Ral 6019 | | | |
| | Ral 7035 | Ral 7037 | Ral 7042 | | | |
| | Ral 7016 | Ral 9006 | Negro/Black/ Noir | | | |
| | | | |  |  |  |
| | | | Lateral Espejo Mirror end panels Joue Miroir | Lat. Panorámico Panoramic end panels Joue panoramique | Lateral Display Display end panels Joue Display | |

Serie / Series / Série **MDGU (DETROIT)**

+Info: www.infrico.com



MN25DGU H1



Nuevo paragolpes frontal

New front bumper

Nouveau pare-chocs frontale



MN37DGU M2

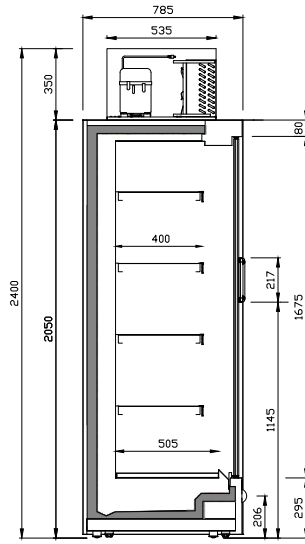

MN DGU M1/M2

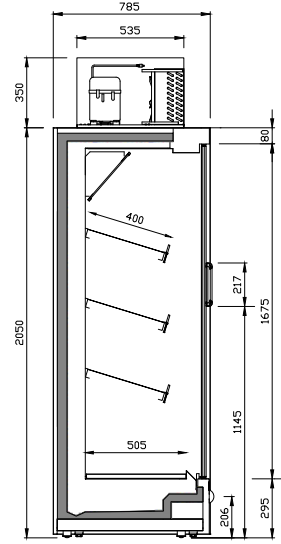

MN DGU H1









Murales Mixtas de refrigeración cerradas

Mixed refrigeration doors multideck

Murales mixtes fermées groupe à distance



| MODELO MODELE MODÈLE |  |  |  |  | |
|---|---|---|---|---|---|
| Precio Price Prix | M1 | 4.054 € | 5.250 € | 6.450 € | 9.354 € |
| MOD. | ML12 DGU M2 | ML18 DGU M2 | ML25 DGU M2 | ML37 DGU M2 | |
| Precio Price Prix | M2 | 4.054 € | 5.250 € | 6.450 € | 9.354 € |
| MOD. | ML12 DGU H1 | ML18 DGU H1 | ML25 DGU H1 | ML37 DGU H1 | |
| Precio Price Prix | H1 | 4.135 € | 5.355 € | 6.579 € | 9.541 € |
| Medidas / Measures / Mesures / (mm) | 1250 x 885 x 2050 mm. | 1875 x 885 x 2050 mm. | 2500 x 885 x 2050 mm. | 3750 x 885 x 2050 mm. | |
| Sin costados / Without sides / Sans joues | | | | | |
| T°. Prod. Aplic. Prod. T°. Applic. T°. (°C) Temp. Prod. Temp. Appliq. | M1: -1/+5°C 0/+2°C M2: -1/+7°C +2/+4°C H1: +1/+10°C +4/+6°C | | | | |
| Clase Climática Climatic class Classe climatique (°C) | 3 / 25°C | | | | |
| Tensión/Frecuencia Electrical data Tension électrique | 230V/1ph/50Hz | | | | |
| Controlador Controller Régulateur | Digital | | | | |
| Material Material Matériel (EXT/INT) | Acero galvanizado plastificado / Plastified galvanised steel / Acier galvanisé plastifié | | | | |
| Aislamiento Isolation Isolation (mm) | 40kg/m ³ / Free CFC's / Zero ODP-GWP | | | | |
| Capacidad Capacity Capacité (L) | 803 | 1204 | 1605 | 2408 | |
| Superficie exposición Surface exhibition Surface d'exposition (x m ²) | 2,76 | 4,13 | 5,51 | 8,30 | |
| Niveles Exposición Exposition Levels Niveaux d'exposition | M1, M2: 4+Expos. H1: 3+Expos. | | | | |
| Costados (2) Sides (2) Joues (2) (mm) | 40 + 40 | | | | |
| Puertas Doors Portes | 2 | 3 | 4 | 6 | |
| Sistema de frío Cooling System Système de froid | Ventilado / Ventilated / Ventilé | | | | |
| Desescarche Defrost Dégivrage | Automático / Automatic / Automatique | | | | |
| Evaporación Evaporation Évaporation | Forzada / Forced / Ventilé | | | | |
| Potencia Power Puissance (W) | M1: 746 M2: 746 H1: 746 | M1: 875 M2: 875 H1: 875 | M1: 1272 M2: 1272 H1: 1272 | M1: 2472 M2: 2472 H1: 2472 | |
| Potencia frig. Cooling capacity Puissance Frig. (W A -10°C) | - | | | | |
| Consumo Consumption Consommation (kWh/ 24h) | M1: 12.5 M2: 11.6 H1: 10.4 | M1: 14.7 M2: 13.6 H1: 12.2 | M1: 21.4 M2: 19.8 H1: 17.7 | M1: 35.6 M2: 32.6 H1: 29.7 | |
| Refrigerante Refrigerant Gaz | R290 | | | | |
| Colores estándar Standar colors Couleurs standard | Int. Estándar / Standar / Standard | | Laterales / Sides / Joues | | |
| | Blanco/White/ Blanc | Negro/Black/ Noir | Ral 7016 | No Incluidos / Not includes / Non inclus | |
| | Ext. Estándar / Standar / Standard | | | | |
| | Blanco/White/ Blanc | Ral 1015 | Ral 1018 | | |
| Laterales disponibles Available sides Joues disponibles | Ral 2003 | Ral 3003 | Ral 3020 | | |
| | Ral 5015 | Ral 5017 | Ral 5011 | | |
| | Ral 6002 | Ral 6018 | Ral 6019 | | |
| | Ral 7035 | Ral 7037 | Ral 7042 | | |
| Opciones pág. 426-427 Options pages 426-427 Options pages 426-427 | Ral 7016 | Ral 9006 | Negro/Black/ Noir | | |
| |    | | | | |
| | | | Lateral Espejo Mirror end panels Joue Miroir | Lat. Panorámico Panoramic end panels Joue panoramique | Lateral Display Display end panels Joue Display |

Serie / Series / Série **MDGU (DETROIT)**

+Info: www.infrico.com



ML37DGU M2



Nuevo
paragolpes
frontal

New
front
bumper

Nouveau
pare-chocs
frontale



ML25DGU H1

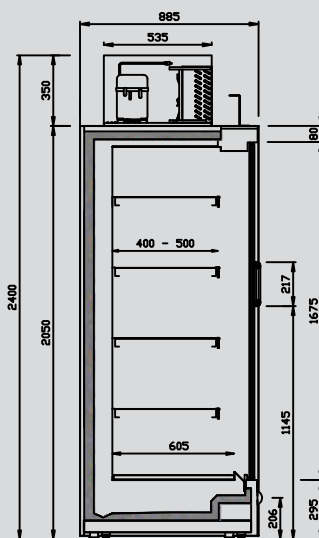

ML DGU M1/M2

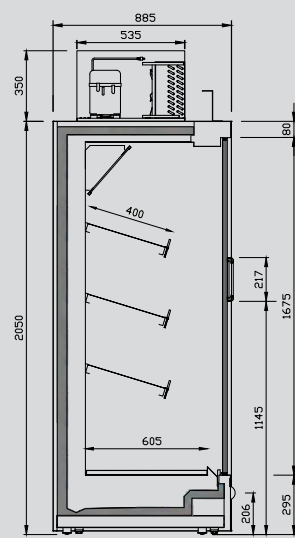

ML DGU H1









Murales Mixtas de refrigeración cerradas

Mixed refrigeration doors multideck

Murales mixtes fermées groupe à distance



| MODELO MODELE MODÈLE |  |  |  |  | | |
|---|---|--|---|---|---|--|
| Precio Price Prix | M1 | 4.298 € | 5.565 € | 6.838 € | 9.916 € | |
| MOD. | ML12 DGU22 M2 | ML18 DGU22 M2 | ML25 DGU22 M2 | ML37 DGU22 M2 | | |
| Precio Price Prix | M2 | 4.298 € | 5.565 € | 6.838€ | 9.916 € | |
| MOD. | ML12 DGU22 H1 | ML18 DGU22 H1 | ML25 DGU22 H1 | ML37 DGU22 H1 | | |
| Precio Price Prix | H1 | 4.341 € | 5.676 € | 6.974 € | 10.115 € | |
| Medidas / Measures / Mesures / (mm) | | 1250 x 885 x 2200 mm. | 1875 x 885 x 2200 mm. | 2500 x 885 x 2200 mm. | 3750 x 885 x 2200 mm. | |
| Sin costados / Without sides / Sans joues | | | | | | |
| T°. Prod. Aplic. Prod. T°. Applic. T°. (°C) Temp. Prod. Temp. Appliq. | | M1: -1/+5°C 0/+2°C M2: -1/+7°C +2/+4°C H1: +1/+10°C +4/+6°C | | | | |
| Clase Climática Climatic class Classe climatique (°C) | | 3 / 25°C | | | | |
| Tensión/Frecuencia Electrical data Tension électrique | | 230V/1ph/50Hz | | | | |
| Controlador Controller Régulateur | | Digital | | | | |
| Material Material (EXT/INT) Matériel | | Acero galvanizado plastificado / Plastified galvanised steel / Acier galvanisé plastifié | | | | |
| Aislamiento Isolation Isolation (mm) | | 40kg/m ³ / Free CFC's / Zero ODP-GWP | | | | |
| Capacidad Capacity Capacité (L) | | M1, M2: 1046 H1: 890 | M1, M2: 1569 H1: 1335 | M1, M2: 2092 H1: 1779 | M1, M2: 3138 H1: 2669 | |
| Superficie exposición Surface exhibition Surface d'exposition (x m ²) | | 3,26 | 4,88 | 6,51 | 9,70 | |
| Niveles Exposición Exposition Levels Niveaux d'exposition | | M1, M2: 5+Expos. H1: 4+Expos. | | | | |
| Costados (2) Sides (2) Joues (2) (mm) | | 40 + 40 | | | | |
| Puertas Doors Portes | | 2 | 3 | 4 | 6 | |
| Sistema de frío Cooling System Système de froid | | Ventilado / Ventilated / Ventilé | | | | |
| Desescarche Defrost Dégivrage | | Automático / Automatic / Automatique | | | | |
| Evaporación Evaporation Évaporation | | Forzada / Forced / Ventilé | | | | |
| Potencia Power Puissance (W) | | M1: 746 M2: 746 H1: 746 | M1: 875 M2: 875 H1: 875 | M1: 1285 M2: 1285 H1: 1285 | M1: 2422 M2: 2422 H1: 2422 | |
| Potencia frig. Cooling capacity Puissance Frig. (W A -10°C) | | - | | | | |
| Consumo Consumption Consommation (kWh/ 24h) | | M1: 12.8 M2: 11.8 H1: 10.61 | M1: 14.9 M2: 13.8 H1: 12.4 | M1: 21.8 M2: 20.3 H1: 18.1 | M1: 36.1 M2: 33.3 H1: 30.3 | |
| Refrigerante Refrigerant Gaz | | R290 | | | | |
| Colores estándar Standar colors Couleurs standard | Int. Estándar / Standar / Standard | | Laterales / Sides / Joues | | | |
| | Blanco/White/ Blanc | Negro/Black/ Noir | Ral 7016 | No Incluidos / Not includes / Non inclus | | |
| Laterales disponibles Available sides Joues disponibles | Ext. Estándar / Standar / Standard | | | | | |
| | Blanco/White/ Blanc | Ral 1015 | Ral 1018 | | | |
| Opciones pág. 426-427 Options pages 426-427 Options pages 426-427 | Ral 2003 | Ral 3003 | Ral 3020 | | | |
| | Ral 5015 | Ral 5017 | Ral 5011 | | | |
| | Ral 6002 | Ral 6018 | Ral 6019 | | | |
| | Ral 7035 | Ral 7037 | Ral 7042 | | | |
| | Ral 7016 | Ral 9006 | Negro/Black/ Noir | | | |
| | | | | | | |
| | | |  |  |  | |
| | | | Lateral Espejo Mirror end panels Joue Miroir | Lat. Panorámico Panoramic end panels Joue panoramique | Lateral Display Display end panels Joue Display | |

Serie / Series / Série **MDGU (DETROIT)**

+Info: www.infrico.com



ML37DGU22 M2



**Nuevo
paragolpes
frontal**

**New
front
bumper**

**Nouveau
pare-chocs
frontale**



ML25DGU22 H1

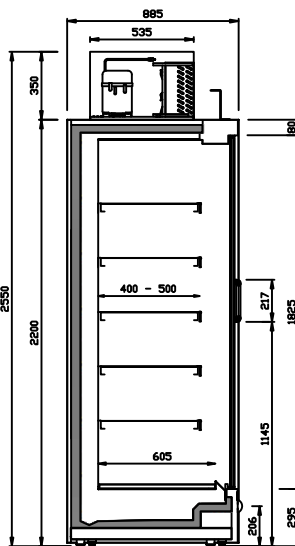

ML DGU22 M1/M2

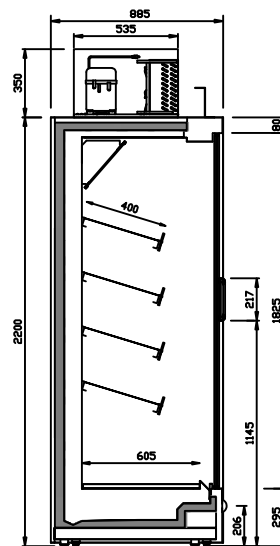

ML DGU22 H1











Mural remota de refrigeración abierta frente bajo

Remote refrigeration open low front multidecks

Murale de réfrigération ouverte groupe à distance avec frontal bas



| MODELO MODELE MODÈLE |  |  |  |  |  | |
|---|--|---|---|---|---|----------------|
| Precio Price Prix | M1 | 2.893 € | 3.182 € | 4.023 € | 4.661 € | 6.322 € |
| MOD. | MN9 PB M2 | MN12 PB M2 | MN18 PB M2 | MN25 PB M2 | MN37 PB M2 | |
| Precio Price Prix | M2 | 2.842 € | 3.125 € | 3.949 € | 4.575 € | 6.203 € |
| MOD. | MN9 PB H1 | MN12 PB H1 | MN18 PB H1 | MN25 PB H1 | MN37 PB H1 | |
| Precio Price Prix | H1 | 2.892 € | 3.180 € | 4.020 € | 4.659 € | 6.320 € |
| Medidas / Measures / Mesures / (mm) | 938 x 785 x 2050 mm. | 1250 x 785 x 2050 mm. | 1875 x 785 x 2050 mm. | 2500 x 785 x 2050 mm. | 3750 x 785 x 2050 mm. | |
| Sin costados / Without sides / Sans joues | | | | | | |
| T°. Prod. Aplic. Prod. T°. Applic. T°. (°C) Temp. Prod. Temp. Appliq. | M1: -1/+5°C 0/+2°C M2: -1/+7°C +2/+4°C H1: +1/+10°C +4/+6°C | | | | | |
| Clase Climática Climatic class Classe climatique (°C) | 3 / 25°C | | | | | |
| Tensión/Frecuencia Electrical data Tension électrique | 230V/1ph/50Hz | | | | | |
| Controlador Controller Régulateur | Digital | | | | | |
| Material Material Matériel (EXT/INT) | Acero galvanizado plastificado / Plastified galvanised steel / Acier galvanisé plastifié | | | | | |
| Aislamiento Isolation Isolation (mm) | 40kg/m ³ / Free CFC's / Zero ODP-GWP | | | | | |
| Capacidad Capacity Capacité (L) | M1, M2: 575 H1: 492 | M1, M2: 766 H1: 655 | M1, M2: 1149 H1: 983 | M1, M2: 1533 H1: 1310 | M1, M2: 2299 H1: 1965 | |
| Superficie exposición Surface exhibition Surface d'exposition (x m ²) | M1, M2: 1,98 H1: 1,60 | M1, M2: 2,64 H1: 2,14 | M1, M2: 3,96 H1: 3,21 | M1, M2: 5,28 H1: 4,28 | M1, M2: 7,91 H1: 6,41 | |
| Niveles Exposición Exposition Levels Niveaux d'exposition | M1, M2: 4+Expos. H1: 3+Expos. | | | | | |
| Costados (2) Sides (2) Joues (2) (mm) | 40 + 40 | | | | | |
| Puertas Doors Portes | - | - | - | - | - | |
| Sistema de frío Cooling System Système de froid | Ventilado / Ventilated / Ventilé | | | | | |
| Desescarche Defrost Dégivrage | Automático / Automatic / Automatique | | | | | |
| Evaporación Evaporation Évaporation | Forzada / Forced / Ventilé | | | | | |
| Potencia Power Puissance (W) | - | - | - | - | - | |
| Potencia frig. Cooling capacity Puissance Frig. (W A -10°C) | M1: 1780 M2: 1636 H1: 1366 | M1: 2373 M2: 2180 H1: 1820 | M1: 3559 M2: 3270 H1: 2730 | M1: 4745 M2: 4360 H1: 3640 | M1: 7118 M2: 6540 H1: 5460 | |
| Consumo Consumption Consommation (kWh/ 24h) | - | - | - | - | - | |
| Refrigerante Refrigerant Gaz | FREON | | | | | |
| Colores estándar Standar colors Couleurs standard | Int. Estándar / Standar / Standard | | Laterales / Sides / Joues | | | |
| | Blanco/White/ Blanc | Negro/Black/ Noir | Ral 7016 | No Incluidos / Not includes / Non inclus | | |
| Laterales disponibles Available sides Joues disponibles | Ext. Estándar / Standar / Standard | | | | | |
| | Blanco/White/ Blanc | Ral 1015 | Ral 1018 | | | |
| Opciones pág. 426-427 Options pages 426-427 Options pages 426-427 | Ral 2003 | Ral 3003 | Ral 3020 | | | |
| | Ral 5015 | Ral 5017 | Ral 5011 | | | |
| | Ral 6002 | Ral 6018 | Ral 6019 | | | |
| | Ral 7035 | Ral 7037 | Ral 7042 | | | |
| | Ral 7016 | Ral 9006 | Negro/Black/ Noir | | | |
| | | | | | | |
| | | |  |  |  | |
| | | | Lateral Espejo Mirror end panels Joue Miroir | Lat. Panorámico Panoramic end panels Joue panoramique | Lateral Display Display end panels Joue Display | |

Serie / Series / Série **MPB (OSLO)**

+Info: www.infrico.com

MN25PB H1



Nuevo paragolpes frontal

New front bumper

Nouveau pare-chocs frontale



MN37PB M2

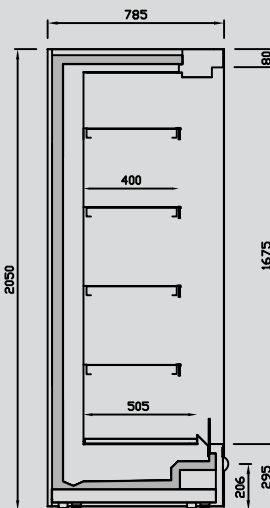

MN PB M1/M2

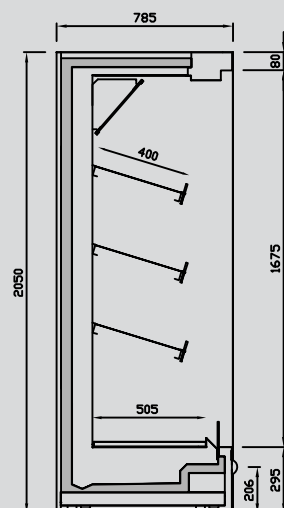

MN PB H1











Mural remota de refrigeración abierta frente bajo

Remote refrigeration open low front multidecks

Murale de réfrigération ouverte groupe à distance avec frontal bas

N: 785

| MODELO MODELE MODÈLE | |  |  |  |  |  | |
|---|----|---|---|---|---|---|--|
| Precio Price Prix | M1 | 3.044 € | 3.351 € | 4.242 € | 4.918 € | 6.679 € | |
| MOD. | | MN9 PB22 M2 | MN12 PB22 M2 | MN18 PB22 M2 | MN25 PB22 M2 | MN37 PB22 M2 | |
| Precio Price Prix | M2 | 2.990 € | 3.291 € | 4.164 € | 4.827 € | 6.553 € | |
| MOD. | | MN9 PB22 H1 | MN12 PB22 H1 | MN18 PB22 H1 | MN25 PB22 H1 | MN37 PB22 H1 | |
| Precio Price Prix | H1 | 3.043 € | 3.350 € | 4.240 € | 4.916 € | 6.677 € | |
| Medidas / Measures / Mesures / (mm) | | 938 x 785 x 2200 mm. | 1250 x 785 x 2200 mm. | 1875 x 785 x 2200 mm. | 2500 x 785 x 2200 mm. | 3750 x 785 x 2200 mm. | |
| Sin costados / Without sides / Sans joues | | | | | | | |
| T°. Prod. Aplic. Prod. T°. Applic. T°. (°C) Temp. Prod. Temp. Appliq. | | M1: -1/+5°C 0/+2°C M2: -1/+7°C +2/+4°C H1: +1/+10°C +4/+6°C | | | | | |
| Clase Climática Climatic class Classe climatique (°C) | | 3 / 25°C | | | | | |
| Tensión/Frecuencia Electrical data Tension électrique | | 230V/1ph/50Hz | | | | | |
| Controlador Controller Régulateur | | Digital | | | | | |
| Material Material Matériel (EXT/INT) | | Acero galvanizado plastificado / Plastified galvanised steel / Acier galvanisé plastifié | | | | | |
| Aislamiento Isolation Isolation (mm) | | 40kg/m³ / Free CFC's / Zero ODP-GWP | | | | | |
| Capacidad Capacity Capacité (L) | | M1, M2: 579 H1: 496 | M1, M2: 771 H1: 660 | M1, M2: 1156 H1: 991 | M1, M2: 1542 H1: 1322 | M1, M2: 2313 H1: 1983 | |
| Superficie exposición Surface exhibition Surface d'exposition (x m²) | | M1, M2: 2,35 H1: 1,95 | M1, M2: 3,13 H1: 2,63 | M1, M2: 4,70 H1: 3,95 | M1, M2: 6,30 H1: 5,30 | M1, M2: 9,40 H1: 7,90 | |
| Niveles Exposición Exposition Levels Niveaux d'exposition | | M1, M2: 5+Expos. H1: 4+Expos. | | | | | |
| Costados (2) Sides (2) Joues (2) (mm) | | 40 + 40 | | | | | |
| Puertas Doors Portes | | - | - | - | - | - | |
| Sistema de frío Cooling System Système de froid | | Ventilado / Ventilated / Ventilé | | | | | |
| Desescarche Defrost Dégivrage | | Automático / Automatic / Automatique | | | | | |
| Evaporación Evaporation Évaporation | | Forzada / Forced / Ventilé | | | | | |
| Potencia Power Puissance (W) | | - | - | - | - | - | |
| Potencia frig. Cooling capacity Puissance Frig. (W A -10°C) | | M1: 2092 M2: 1907 H1: 1521 | M1: 2788 M2: 2541 H1: 2028 | M1: 4181 M2: 3812 H1: 3041 | M1: 5575 M2: 5083 H1: 4055 | M1: 8363 M2: 7624 H1: 6083 | |
| Consumo Consumption Consommation (kWh/ 24h) | | - | - | - | - | - | |
| Refrigerante Refrigerant Gaz | | FREON | | | | | |
| Colores estándar Standar colors Couleurs standard | | Int. Estándar / Standar / Standard | | Laterales / Sides / Joues | | | |
| | | Blanco/White/ Blanc | Negro/Black/ Noir | Ral 7016 | No Incluidos / Not includes / Non inclus | | |
| Laterales disponibles Available sides Joues disponibles | | Ext. Estándar / Standar / Standard | | | | | |
| | | Blanco/White/ Blanc | Ral 1015 | Ral 1018 | | | |
| | | Ral 2003 | Ral 3003 | Ral 3020 | | | |
| | | Ral 5015 | Ral 5017 | Ral 5011 | | | |
| | | Ral 6002 | Ral 6018 | Ral 6019 | | | |
| | | Ral 7035 | Ral 7037 | Ral 7042 | | | |
| | | Ral 7016 | Ral 9006 | Negro/Black/ Noir | | | |
| Opciones pág. 426-427 Options pages 426-427 Options pages 426-427 | |    | | | | | |
| | | Lateral Espejo Mirror end panels Joue Miroir | | | | | |
| | | Lat. Panorámico Panoramic end panels Joue panoramique | | | | | |
| | | Lateral Display Display end panels Joue Display | | | | | |

Serie / Series / Série **MPB (OSLO)**

+Info: www.infrico.com

MN37PB22 M2



MN25PB22 H1

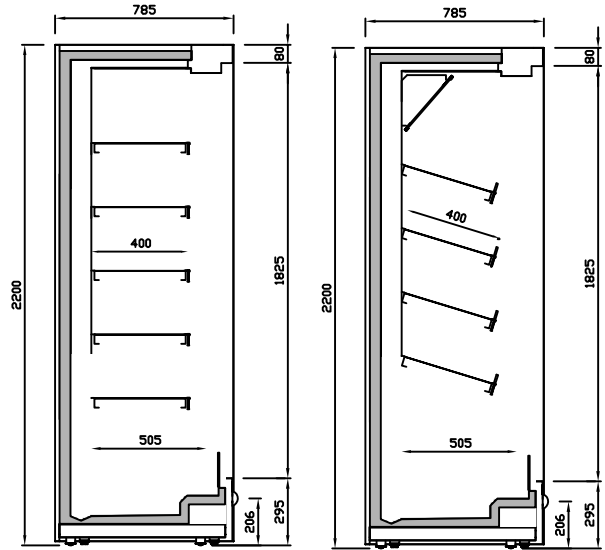

MN PB22 M1/M2

MN PB22 H1



Mural remota de refrigeración abierta frente bajo

Remote refrigeration open low front multidecks

Murale de réfrigération ouverte groupe à distance avec frontal bas



| MODELO MODELE MODÈLE | | ML9 PB M1 | ML12 PB M1 | ML18 PB M1 | ML25 PB M1 | ML31 PB M1 | ML37 PB M1 |
|---|------------------------------------|--|-------------------------------|-------------------------------|--|-------------------------------|-------------------------------|
| Precio Price Prix | M1 | 2.970 € | 3.269 € | 4.136 € | 4.793 € | 5.765 € | 6.444 € |
| MOD. | | ML9 PB M2 | ML12 PB M2 | ML18 PB M2 | ML25 PB M2 | ML31 PB M2 | ML37 PB M2 |
| Precio Price Prix | M2 | 2.918 € | 3.211 € | 4.060 € | 4.705 € | 5.656 € | 6.322 € |
| MOD. | | ML9 PB H1 | ML12 PB H1 | ML18 PB H1 | ML25 PB H1 | ML31 PB H1 | ML37 PB H1 |
| Precio Price Prix | H1 | 2.969 € | 3.268 € | 4.134 € | 4.792 € | 5.762 € | 6.441 € |
| Medidas / Measures / Mesures / (mm) | | 938 x 885 x 2050 mm. | 1250 x 885 x 2050 mm. | 1875 x 885 x 2050 mm. | 2500 x 885 x 2050 mm. | 3125 x 885 x 2050 mm. | 3750 x 885 x 2050 mm. |
| Sin costados / Without sides / Sans joues | | | | | | | |
| T°. Prod. Aplic. Prod. T°. Applic. T°. (°C) Temp. Prod. Temp. Appliq. | | M1: -1/+5°C 0/+2°C M2: -1/+7°C +2/+4°C H1: +1/+10°C +4/+6°C | | | | | |
| Clase Climática Climatic class Classe climatique (°C) | | 3 / 25°C | | | | | |
| Tensión/Frecuencia Electrical data Tension électrique | | 230V/1ph/50Hz | | | | | |
| Controlador Controller Régulateur | | Digital | | | | | |
| Material Material (EXT/INT) Matériel | | Acero galvanizado plastificado / Plastified galvanised steel / Acier galvanisé plastifié | | | | | |
| Aislamiento Isolation (mm) Isolation | | 40kg/m ³ / Free CFC's / Zero ODP-GWP | | | | | |
| Capacidad Capacity (L) Capacité | | M1, M2: 602 H1: 520 | M1, M2: 803 H1: 701 | M1, M2: 1204 H1: 1143 | M1, M2: 1605 H1: 1390 | M1, M2: 2012 H1: 1650 | M1, M2: 2408 H1: 2110 |
| Superficie exposición Surface exhibition (x m ²) Surface d'exposition | | M1, M2: 2,07 H1: 1,69 | M1, M2: 2,76 H1: 2,26 | M1, M2: 4,10 H1: 3,40 | M1, M2: 5,50 H1: 4,50 | M1, M2: 6,80 H1: 5,60 | M1, M2: 8,30 H1: 6,70 |
| Niveles Exposición Exposition Levels Niveaux d'exposition | | M1, M2: 4+Expos. H1: 3+Expos. | | | | | |
| Costados (2) Sides (2) (mm) Joues (2) | | 40 + 40 | | | | | |
| Puertas Doors Portes | | - | - | - | - | - | - |
| Sistema de frío Cooling System Système de froid | | Ventilado / Ventilated / Ventilé | | | | | |
| Desescarche Defrost Dégivrage | | Automático / Automatic / Automatique | | | | | |
| Evaporación Evaporation Évaporation | | Forzada / Forced / Ventilé | | | | | |
| Potencia Power (W) Puissance | | - | - | - | - | - | - |
| Potencia frig. Cooling capacity Puissance Frig. (W A -10°C) | | M1: 1696 M2: 1558 H1: 1300 | M1: 2260 M2: 2076 H1: 1733 | M1: 3190 M2: 3114 H1: 2599 | M1: 4250 M2: 4153 H1: 3465 | M1: 5650 M2: 5191 H1: 4331 | M1: 6780 M2: 6229 H1: 5198 |
| Consumo Consumption (kWh/ 24h) Consommation | | - | - | - | - | - | - |
| Refrigerante Refrigerant Gaz | | FREON | | | | | |
| Colores estándar Standard colors Couleurs standard | Int. Estándar / Standar / Standard | Blanco/White/ Blanc | Negro/Black/ Noir | Ral 7016 | No Incluidos / Not includes / Non inclus | | |
| | Ext. Estándar / Standar / Standard | Blanco/White/ Blanc | Ral 1015 | Ral 1018 | | | |
| Laterales disponibles Available sides Joues disponibles | | Ral 2003 | Ral 3003 | Ral 3020 | | | |
| | | Ral 5015 | Ral 5017 | Ral 5011 | | | |
| Opciones pág. 426-427 Options pages 426-427 Options pages 426-427 | | Ral 6002 | Ral 6018 | Ral 6019 | | | |
| | | Ral 7035 | Ral 7037 | Ral 7042 | | | |
| | | Ral 7016 | Ral 9006 | Negro/Black/ Noir | | | |
| | | Laterales / Sides / Joues | | | | | |

Serie / Series / Série **MPB (OSLO)**

+Info: www.infrico.com

ML37PB M2



ML25PB H1

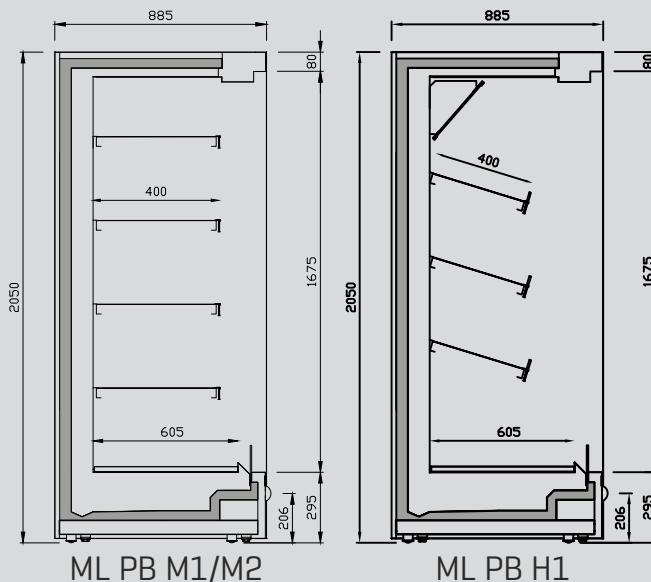

Los datos técnicos de este catálogo se actualizan periódicamente en el fichero de datos técnicos de los productos que se encuentran en el sitio web. Les données techniques peuvent varier et seront actualisées concurremment périodiquement dans le fichier des données techniques des produits disponibles sur le site web.

Mural remota de refrigeración abierta frente bajo

Remote refrigeration open low front multidecks

Murale de réfrigération ouverte groupe à distance avec frontal bas



| MODELO MODELE MODÈLE | ML9 PB22 M1 | ML12 PB22 M1 | ML18 PB22 M1 | ML25 PB22 M1 | ML31 PB22 M1 | ML37 PB22 M1 | |
|---|--|------------------------------|---|--|---|-----------------------------|----------------|
| Precio Price Prix | M1 | 3.101 € | 3.414 € | 4.324 € | 5.015 € | 6.034 € | 6.747 € |
| MOD. | ML9 PB22 M2 | ML12 PB22 M2 | ML18 PB22 M2 | ML25 PB22 M2 | ML31 PB22 M2 | ML37 PB22 M2 | ML37 PB22 M2 |
| Precio Price Prix | M2 | 3.071 € | 3.381 € | 4.282 € | 4.965 € | 5.973 € | 6.679 € |
| MOD. | ML9 PB22 H1 | ML12 PB22 H1 | ML18 PB22 H1 | ML25 PB22 H1 | ML31 PB22 H1 | ML37 PB22 H1 | ML37 PB22 H1 |
| Precio Price Prix | H1 | 3.126 € | 3.442 € | 4.360 € | 5.058 € | 6.086 € | 6.805 € |
| Medidas / Measures / Mesures / (mm) | 938 x 885 x 2200 mm. | 1250 x 885 x 2200 mm. | 1875 x 885 x 2200 mm. | 2500 x 885 x 2200 mm. | 3125 x 885 x 2200 mm. | 3750 x 885 x 2200 mm. | |
| Sin costados / Without sides / Sans joues | | | | | | | |
| T°. Prod. Aplic. Prod. T°. Applic. T°. (°C) Temp. Prod. Temp. Appliq. | M1: -1/+5°C 0/+2°C M2: -1/+7°C +2/+4°C H1: +1/+10°C +4/+6°C | | | | | | |
| Clase Climática Climatic class Classe climatique (°C) | 3 / 25°C | | | | | | |
| Tensión/Frecuencia Electrical data Tension électrique | 230V/1ph/50Hz | | | | | | |
| Controlador Controller Régulateur | Digital | | | | | | |
| Material Material Matériel (EXT/INT) | Acero galvanizado plastificado / Plastified galvanised steel / Acier galvanisé plastifié | | | | | | |
| Aislamiento Isolation Isolation (mm) | 40kg/m ³ / Free CFC's / Zero ODP-GWP | | | | | | |
| Capacidad Capacity Capacité (L) | M1, M2: 637 H1: 575 | M1, M2: 849 H1: 742 | M1, M2: 1273 H1: 1195 | M1, M2: 1698 H1: 1480 | M1, M2: 2105 H1: 1148 | M1, M2: 2503 H1: 2205 | |
| Superficie exposición Surface exhibition Surface d'exposition (x m ²) | M1, M2: 2,44 H1: 2,07 | M1, M2: 3,30 H1: 2,70 | M1, M2: 4,88 H1: 4,13 | M1, M2: 6,50 H1: 5,50 | M1, M2: 8,10 H1: 6,90 | M1, M2: 9,70 H1: 8,30 | |
| Niveles Exposición Exposition Levels Niveaux d'exposition | M1, M2: 4+Expos. H1: 3+Expos. | | | | | | |
| Costados (2) Sides (2) Joues (2) (mm) | 40 + 40 | | | | | | |
| Puertas Doors Portes | - | - | - | - | - | - | - |
| Sistema de frío Cooling System Système de froid | Ventilado / Ventilated / Ventilé | | | | | | |
| Desescarche Defrost Dégivrage | Automático / Automatic / Automatique | | | | | | |
| Evaporación Evaporation Évaporation | Forzada / Forced / Ventilé | | | | | | |
| Potencia Power Puissance (W) | - | - | - | - | - | - | - |
| Potencia frig. Cooling capacity Puissance Frig. (W A -10°C) | M1: 1889 M2:1816 H1: 1448 | M1: 2650 M2: 2420 H1:1930 | M1: 3975 M2:3630 H1: 2895 | M1: 5300 M2:4840 H1:3860 | M1:6625 M2: 6050 H1:4825 | M1:7950 M2:7260 H1: 5790 | |
| Consumo Consumption Consommation (kWh/ 24h) | - | - | - | - | - | - | - |
| Refrigerante Refrigerant Gaz | FREON | | | | | | |
| Colores estándar Standar colors Couleurs standard | Int. Estándar / Standar / Standard | | | Laterales / Sides / Joues | | | |
| | Blanco/White/ Blanc | Negro/Black/ Noir | Ral 7016 | No Incluidos / Not includes / Non inclus | | | |
| Laterales disponibles Available sides Joues disponibles | Ext. Estándar / Standar / Standard | | | | | | |
| | Blanco/White/ Blanc | Ral 1015 | Ral 1018 | | | | |
| Opciones pág. 426-427 Options pages 426-427 Options pages 426-427 | Ral 2003 | Ral 3003 | Ral 3020 | | | | |
| | Ral 5015 | Ral 5017 | Ral 5011 | | | | |
| | Ral 6002 | Ral 6018 | Ral 6019 | | | | |
| | Ral 7035 | Ral 7037 | Ral 7042 | | | | |
| | Ral 7016 | Ral 9006 | Negro/Black/ Noir | | | | |
| | Lateral Espejo Mirror end panels Joue Miroir | | Lat. Panorámico Panoramic end panels Joue panoramique | | Lateral Display Display end panels Joue Display | | |

Serie / Series / Série **MPB (OSLO)**

+Info: www.infrico.com

ML25PB22 H1



ML37PB22 M2

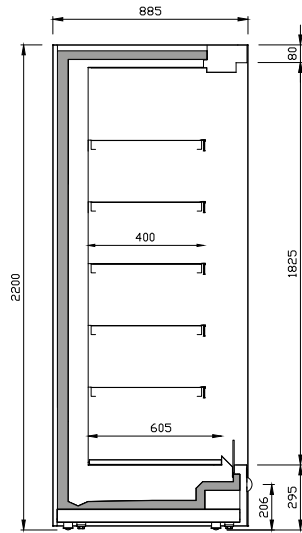

ML PB22 M1/M2

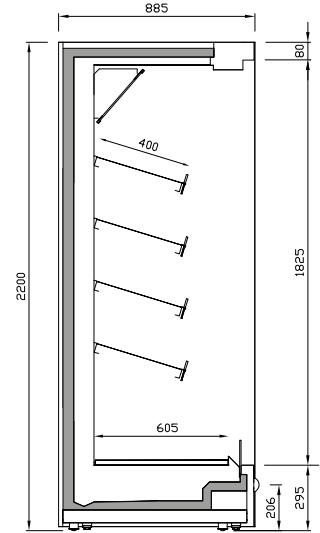

ML PB22 H1





Mural remota de refrigeración abierta frente bajo

Remote refrigeration open low front multidecks

Murale de réfrigération ouverte groupe à distance avec frontal bas



| MODELO MODELE MODÈLE | | | | | | | |
|---|----|--|----------------------|---|--|----------------------|--|
| Precio Price Prix | M2 | 3.649 € | 4.465 € | 5.306 € | 6.300 € | 7.142 € | |
| MOD. | | MX12 PB H1 | MX18 PB H1 | MX25 PB H1 | MX31 PB H1 | MX37 PB H1 | |
| Precio Price Prix | H1 | 3.714 € | 4.547 € | 5.404 € | 6.419 € | 7.278 € | |
| Medidas / Measures / Mesures / (mm) | | 1250 x 1085 | 1875 x 1085 | 2500 x 1085 | 3125 x 1085 | 3750 x 1085 | |
| Sin costados / Without sides / Sans joues | | x 2050 mm. | x 2050 mm. | x 2050 mm. | x 2050 mm. | x 2050 mm. | |
| T°. Prod. Aplic. Prod. T°. Applic. T°. (°C) Temp. Prod. Temp. Appliq. | | M2: -1/+7°C +2/+4°C H1: +1/+10°C +4/+6°C | | | | | |
| Clase Climática Climatic class Classe climatique (°C) | | 3 / 25°C | | | | | |
| Tensión/Frecuencia Electrical data Tension électrique | | 230V/1ph/50Hz | | | | | |
| Controlador Controller Régulateur | | Digital | | | | | |
| Material Material Matériel (EXT/INT) | | Acero galvanizado plastificado / Plastified galvanised steel / Acier galvanisé plastifié | | | | | |
| Aislamiento Isolation Isolation (mm) | | 40kg/m ³ / Free CFC's / Zero ODP-GWP | | | | | |
| Capacidad Capacity Capacité (L) | | M2: 801 H1: 651 | M2: 1202 H1: 976 | M2: 1603 H1: 1303 | M2: 2003 H1: 1628 | M2: 2404 H1: 1954 | |
| Superficie exposición Surface exhibition Surface d'exposition (x m ²) | | M2: 4,01 H1: 3,26 | M2: 6,01 H1: 4,28 | M2: 8,01 H1: 6,50 | M2: 10,1 H1: 8,20 | M2: 12,1 H1: 9,70 | |
| Niveles Exposición Exposition Levels Niveaux d'exposition | | M2: 4+Expos. H1: 3+Expos. | | | | | |
| Costados (2) Sides (2) Joues (2) (mm) | | 40 + 40 | | | | | |
| Puertas Doors Portes | | - | - | - | - | - | |
| Sistema de frío Cooling System Système de froid | | Ventilado / Ventilated / Ventilé | | | | | |
| Desescarche Defrost Dégivrage | | Automático / Automatic / Automatique | | | | | |
| Evaporación Evaporation Évaporation | | Forzada / Forced / Ventilé | | | | | |
| Potencia Power Puissance (W) | | - | - | - | - | - | |
| Potencia frig. Cooling capacity Puissance Frig. (W A -10°C) | | M2: 2430 H1: 2028 | M2: 3645 H1: 3041 | M2: 4860 H1: 4055 | M2: 6075 H1: 5069 | M2: 7290 H1: 6083 | |
| Consumo Consumption Consommation (kWh/ 24h) | | - | - | - | - | - | |
| Refrigerante Refrigerant Gaz | | FREON | | | | | |
| Colores estándar Standar colors Couleurs standard | | Int. Estándar / Standar / Standard | | Laterales / Sides / Joues | | | |
| Laterales disponibles Available sides Joues disponibles | | Blanco/White/ Blanc | Negro/Black/ Noir | Ral 7016 | No Incluidos / Not includes / Non inclus | | |
| Opciones pág. 426-427 Options pages 426-427 Options pages 426-427 | | Ext. Estándar / Standar / Standard | |    | | | |
| | | Blanco/White/ Blanc | Ral 1015 | Ral 1018 | | | |
| | | Ral 2003 | Ral 3003 | Ral 3020 | | | |
| | | Ral 5015 | Ral 5017 | Ral 5011 | | | |
| | | Ral 6002 | Ral 6018 | Ral 6019 | | | |
| | | Ral 7035 | Ral 7037 | Ral 7042 | | | |
| | | Ral 7016 | Ral 9006 | Negro/Black/ Noir | | | |

MX37PB M2



MX25PB H1

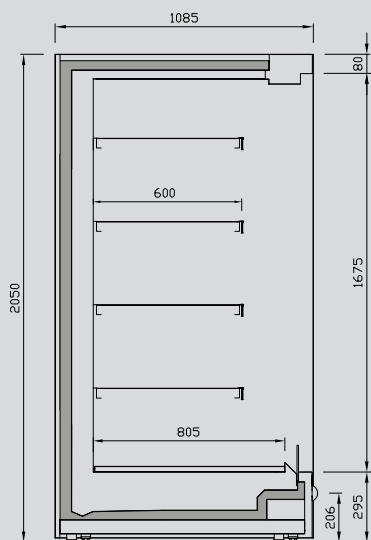

MX PB M2

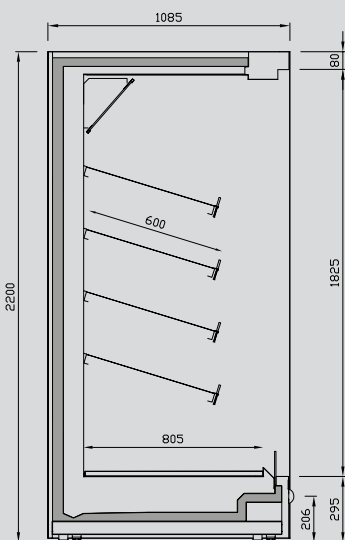

MX PB H1



Mural remota de refrigeración abierta frente bajo

Remote refrigeration open low front multidecks

Murale de réfrigération ouverte groupe à distance avec frontal bas



| MODELO MODELE MODÈLE | | | | | | |
|---|----|---|----------------------|--|----------------------|----------------------|
| Precio Price Prix | M2 | 3.845 € | 4.710 € | 5.602 € | 6.656 € | 7.548 € |
| MOD. | | MX12 PB22 H1 | MX18 PB22 H1 | MX25 PB22 H1 | MX31 PB22 H1 | MX37 PB22 H1 |
| Precio Price Prix | H1 | 3.914 € | 4.797 € | 5.707 € | 6.782 € | 7.692 € |
| Medidas / Measures / Mesures / (mm) | | 1250 x 1085 | 1875 x 1085 | 2500 x 1085 | 3125 x 1085 | 3750 x 1085 |
| Sin costados / Without sides / Sans joues | | x 2200 mm. | x 2200 mm. | x 2200 mm. | x 2200 mm. | x 2200 mm. |
| T°. Prod. Aplic. Prod. T°. Applic. T°. (°C) Temp. Prod. Temp. Appliq. | | M2: -1/+7°C +2/+4°C H1: +1/+10°C +4/+6°C | | | | |
| Clase Climática Climatic class Classe climatique (°C) | | 3 / 25°C | | | | |
| Tensión/Frecuencia Electrical data Tension électrique | | 230V/1ph/50Hz | | | | |
| Controlador Controller Régulateur | | Digital | | | | |
| Material Material Matériel (EXT/INT) | | Acero galvanizado plastificado / Plastified galvanised steel / Acier galvanisé plastifié | | | | |
| Aislamiento Isolation Isolation (mm) | | 40kg/m ³ / Free CFC's / Zero ODP-GWP | | | | |
| Capacidad Capacity Capacité (L) | | M2: 951 H1: 801 | M2: 1427 H1: 1202 | M2: 1903 H1: 1603 | M2: 2378 H1: 2003 | M2: 2854 H1: 2404 |
| Superficie exposición Surface exhibition Surface d'exposition (x m ²) | | M2: 4,80 H1: 4,00 | M2: 7,10 H1: 6,02 | M2: 9,50 H1: 8,10 | M2: 11,9 H1: 10,1 | M2: 14,3 H1: 12,0 |
| Niveles Exposición Exposition Levels Niveaux d'exposition | | M1, M2: 5+Expos. H1: 4+Expos. | | | | |
| Costados (2) Sides (2) Joues (2) (mm) | | 40 + 40 | | | | |
| Puertas Doors Portes | | - | - | - | - | - |
| Sistema de frío Cooling System Système de froid | | Ventilado / Ventilated / Ventilé | | | | |
| Desescarche Defrost Dégivrage | | Automático / Automatic / Automatique | | | | |
| Evaporación Evaporation Évaporation | | Forzada / Forced / Ventilé | | | | |
| Potencia Power Puissance (W) | | - | - | - | - | - |
| Potencia frig. Cooling capacity Puissance Frig. (W A -10°C) | | M2: 2833 H1: 2259 | M2: 4249 H1: 3388 | M2: 5665 H1: 4518 | M2: 7081 H1: 5647 | M2: 8498 H1: 6776 |
| Consumo Consumption Consommation (kWh/ 24h) | | - | - | - | - | - |
| Refrigerante Refrigerant Gaz | | FREON | | | | |
| Colores estándar Standar colors Couleurs standard | | Int. Estándar / Standar / Standard Blanco/White/ Blanc Negro/Black/ Noir Ral 7016 | | Laterales / Sides / Joues No Incluidos / Not includes / Non inclus | | |
| Laterales disponibles Available sides Joues disponibles | | Ext. Estándar / Standar / Standard Blanco/White/ Blanc Ral 1015 Ral 1018 Ral 2003 Ral 3003 Ral 3020 Ral 5015 Ral 5017 Ral 5011 Ral 6002 Ral 6018 Ral 6019 Ral 7035 Ral 7037 Ral 7042 Ral 7016 Ral 9006 Negro/Black/ Noir | | | | |
| Opciones pág. 426-427 Options pages 426-427 Options pages 426-427 | | | | | | |

Serie / Series / Série **MPB (OSLO)**

+Info: www.infrico.com

MX25PB22 H1



MX37PB22 M2

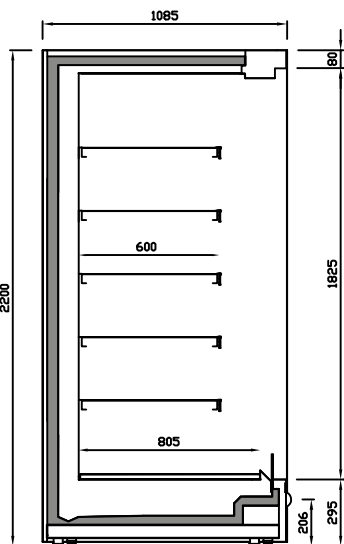

MX PB22 M2

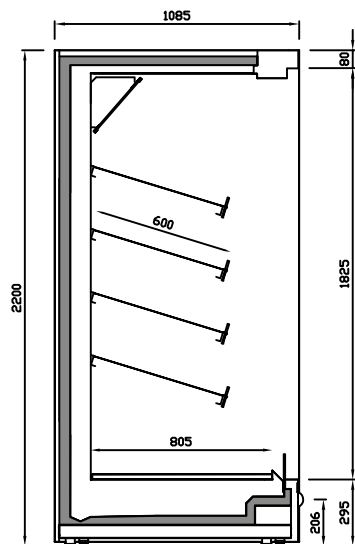

MX PB22 H1



BEBIDAS







Mural remota de congelación cerrada

Remote freezer full glass doors multidecks

Murale congélation fermée groupe à distance



| MODELO MODELE MODÈLE |  |  |  |  | | | | | | | | | | | | | | | | | | |
|---|--|---|---|---|--|----------|--|----------|----------|----------|----------|----------|----------|----------|----------|----------|----------|----------|----------|----------------------|---|--|
| Precio Price Prix | L1 6.966 € | 8.605 € | 10.447 € | 12.304 € | | | | | | | | | | | | | | | | | | |
| MOD. | MN2P BT22 L1 | MN3P BT22 L1 | MN4P BT22 L1 | MN5P BT22 L1 | | | | | | | | | | | | | | | | | | |
| Precio Price Prix | L1 7.112 € | 8.833 € | 10.773 € | 12.733 € | | | | | | | | | | | | | | | | | | |
| Medidas / Measures / Mesures / (mm) | 1562 x 780 x 2050 mm. | 2343 x 780 x 2050 mm. | 3124 x 780 x 2050 mm. | 3905 x 780 x 2050 mm. | | | | | | | | | | | | | | | | | | |
| Sin costados / Without sides / Sans joues | 1562 x 780 x 2200 mm. [22] | 2343 x 780 x 2200 mm. [22] | 3124 x 780 x 2200 mm. [22] | 3905 x 780 x 2200 mm. [22] | | | | | | | | | | | | | | | | | | |
| T°. Prod. Aplic. Prod. T°. Applic. T°. (°C) Temp. Prod. Temp. Appliq. | L1: -15/-18°C -23/-25°C | | | | | | | | | | | | | | | | | | | | | |
| Clase Climática Climatic class Classe climatique (°C) | 3 / 25°C | | | | | | | | | | | | | | | | | | | | | |
| Tensión/Frecuencia Electrical data Tension électrique | 230V/1ph/50Hz | | | | | | | | | | | | | | | | | | | | | |
| Controlador Controller Régulateur | Digital | | | | | | | | | | | | | | | | | | | | | |
| Material Material Matériel (EXT/INT) | Acero galvanizado plastificado / Plastified galvanised steel / Acier galvanisé plastifié | | | | | | | | | | | | | | | | | | | | | |
| Aislamiento Isolation Isolation (mm) | 40kg/m ³ / Free CFC's / Zero ODP-GWP | | | | | | | | | | | | | | | | | | | | | |
| Capacidad Capacity Capacité (L) | L1: 659 L1 22: 822 | L1: 989 L1 22: 1233 | L1: 1318 L1 22: 1844 | L1: 1648 L1 22: 2055 | | | | | | | | | | | | | | | | | | |
| Área refrigerada Refrigerated area Zone réfrigérée (x m ²) | L1: 3,20 L1 22: 3,91 | L1: 4,70 L1 22: 5,87 | L1: 6,30 L1 22: 7,83 | L1: 7,90 L1 22: 9,78 | | | | | | | | | | | | | | | | | | |
| Niveles Exposición Exposition Levels Niveaux d'exposition | L1: 4+Expos. L1 22: 5+Expos. | | | | | | | | | | | | | | | | | | | | | |
| Costados [2] Sides [2] Joues [2] (mm) | 60 + 60 | | | | | | | | | | | | | | | | | | | | | |
| Puertas Doors Portes | 2 | 3 | 4 | 5 | | | | | | | | | | | | | | | | | | |
| Sistema de frío Cooling System Système de froid | Ventilado / Ventilated / Ventilé | | | | | | | | | | | | | | | | | | | | | |
| Desescarche Defrost Dégivrage | Automático / Automatic / Automatique | | | | | | | | | | | | | | | | | | | | | |
| Evaporación Evaporation Évaporation | Forzada / Forced / Ventilé | | | | | | | | | | | | | | | | | | | | | |
| Potencia Power Puissance (W) | - | | | | | | | | | | | | | | | | | | | | | |
| Potencia frig. Cooling capacity Puissance Frig. (W A -10°C) | L1: 1207 L1 22: 1298 | L1: 1809 L1 22: 1947 | L1: 2412 L1 22: 2596 | L1: 3015 L1 22: 3245 | | | | | | | | | | | | | | | | | | |
| Consumo Consumption Consommation (kWh/ 24h) | - | | | | | | | | | | | | | | | | | | | | | |
| Refrigerante Refrigerant Gaz | FREON | | | | | | | | | | | | | | | | | | | | | |
| Colores estándar Standar colors Couleurs standard | Int. Estándar / Standar / Standard <table border="1"> <tr> <td>Blanco/White/ Blanc</td> <td>Negro/Black/ Noir</td> </tr> </table> | | Blanco/White/ Blanc | Negro/Black/ Noir | Laterales / Sides / Joues <table border="1"> <tr> <td colspan="3">No Incluidos / Not includes / Non inclus</td> </tr> </table> | | No Incluidos / Not includes / Non inclus | | | | | | | | | | | | | | | |
| Blanco/White/ Blanc | Negro/Black/ Noir | | | | | | | | | | | | | | | | | | | | | |
| No Incluidos / Not includes / Non inclus | | | | | | | | | | | | | | | | | | | | | | |
| Laterales disponibles Available sides Joues disponibles | Ext. Estándar / Standar / Standard <table border="1"> <tr> <td>Blanco/White/ Blanc</td> <td>Ral 1015</td> <td>Ral 1018</td> </tr> <tr> <td>Ral 2003</td> <td>Ral 3003</td> <td>Ral 3020</td> </tr> <tr> <td>Ral 5015</td> <td>Ral 5017</td> <td>Ral 5011</td> </tr> <tr> <td>Ral 6002</td> <td>Ral 6018</td> <td>Ral 6019</td> </tr> <tr> <td>Ral 7035</td> <td>Ral 7037</td> <td>Ral 7042</td> </tr> <tr> <td>Ral 7016</td> <td>Ral 9006</td> <td>Negro/Black/ Noir</td> </tr> </table> | | Blanco/White/ Blanc | Ral 1015 | Ral 1018 | Ral 2003 | Ral 3003 | Ral 3020 | Ral 5015 | Ral 5017 | Ral 5011 | Ral 6002 | Ral 6018 | Ral 6019 | Ral 7035 | Ral 7037 | Ral 7042 | Ral 7016 | Ral 9006 | Negro/Black/ Noir |  Lateral Espejo Mirror end panels Joue Miroir | |
| Blanco/White/ Blanc | Ral 1015 | Ral 1018 | | | | | | | | | | | | | | | | | | | | |
| Ral 2003 | Ral 3003 | Ral 3020 | | | | | | | | | | | | | | | | | | | | |
| Ral 5015 | Ral 5017 | Ral 5011 | | | | | | | | | | | | | | | | | | | | |
| Ral 6002 | Ral 6018 | Ral 6019 | | | | | | | | | | | | | | | | | | | | |
| Ral 7035 | Ral 7037 | Ral 7042 | | | | | | | | | | | | | | | | | | | | |
| Ral 7016 | Ral 9006 | Negro/Black/ Noir | | | | | | | | | | | | | | | | | | | | |
| Opciones pág. 426-427 Options pages 426-427 Options pages 426-427 | | | | | | | | | | | | | | | | | | | | | | |

Serie / Series / Série **MBT (TORONTO)**

+Info: www.infrico.com



MN5P BT22 L1



Nuevo paragolpes frontal

New front bumper

Nouveau pare-chocs frontale



MN5P BT L1

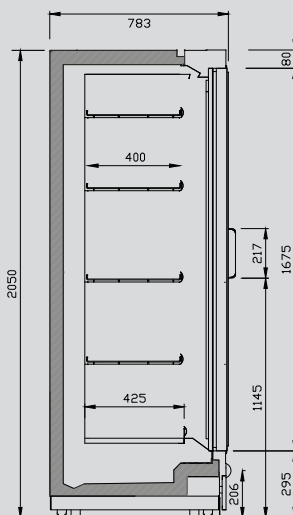

MN BT L1

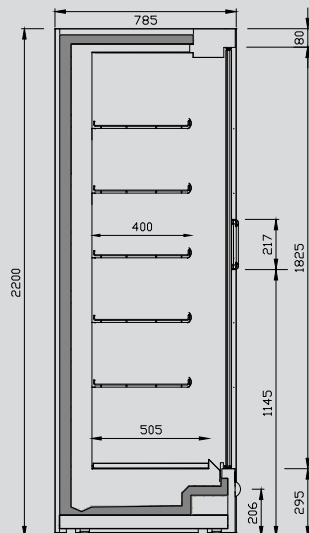

MN BT22 L1









Los datos técnicos están sujetos a posibles variaciones que serán actualizadas periódicamente en las fichas técnicas del producto, disponibles en el sitio web.
 The technical data are subject to possible variations that will be updated periodically in the technical data sheets of the product, which are available on the website.
 Les données techniques peuvent varier et seront actualisées dans les fiches techniques du produit, disponibles sur le site web.

Mural remota de congelación cerrada

Remote freezer full glass doors multidecks

Murale congélation fermée groupe à distance



| MODELO MODELE MODÈLE |  |  |  |  | | | | | | | | | | | | | | | | | | |
|---|--|---|---|---|----------|----------|----------|----------|----------|----------|----------|----------|----------|----------|----------|----------|----------|----------|----------|------------------|--|--|
| Precio Price Prix | L1 7.149 € | 8.872 € | 10.724 € | 12.876 € | | | | | | | | | | | | | | | | | | |
| MOD. | MF2P BT22 L1 | MF3P BT22 L1 | MF4P BT22 L1 | MF5P BT22 L1 | | | | | | | | | | | | | | | | | | |
| Precio Price Prix | L1 7.418 € | 9.254 € | 11.216 € | 13.478 € | | | | | | | | | | | | | | | | | | |
| Medidas / Measures / Mesures / (mm) | 1562 x 980 x 2050 mm. | 2343 x 980 x 2050 mm. | 3124 x 980 x 2050 mm. | 3905 x 980 x 2050 mm. | | | | | | | | | | | | | | | | | | |
| Sin costados / Without sides / Sans joues | 1562 x 980 x 2200 mm. [22] | 2343 x 980 x 2200 mm. [22] | 3124 x 980 x 2200 mm. [22] | 3905 x 980 x 2200 mm. [22] | | | | | | | | | | | | | | | | | | |
| T°. Prod. Aplic. Prod. T°. Applic. T°. (°C) Temp. Prod. Temp. Appliq. | L1: -15/-18°C -23/-25°C | | | | | | | | | | | | | | | | | | | | | |
| Clase Climática Climatic class Classe climatique (°C) | 3 / 25°C | | | | | | | | | | | | | | | | | | | | | |
| Tensión/Frecuencia Electrical data Tension électrique | 230V/1ph/50Hz | | | | | | | | | | | | | | | | | | | | | |
| Controlador Controller Régulateur | Digital | | | | | | | | | | | | | | | | | | | | | |
| Material Material Matériel (EXT/INT) | Acero galvanizado plastificado / Plastified galvanised steel / Acier galvanisé plastifié | | | | | | | | | | | | | | | | | | | | | |
| Aislamiento Isolation Isolation (mm) | 40kg/m ³ / Free CFC's / Zero ODP-GWP | | | | | | | | | | | | | | | | | | | | | |
| Capacidad Capacity Capacité (L) | L1: 1232 L1 22: 1466 | L1: 1845 L1 22: 2197 | L1: 2460 L1 22: 2929 | L1: 3075 L1 22: 3661 | | | | | | | | | | | | | | | | | | |
| Área refrigerada Refrigerated area Zone réfrigérée (x m ²) | L1: 4,7 L1 22: 5,7 | L1: 7,1 L1 22: 8,5 | L1: 9,45 L1 22: 11,3 | L1: 11,8 L1 22: 14,2 | | | | | | | | | | | | | | | | | | |
| Niveles Exposición Exposition Levels Niveaux d'exposition | L1: 4+Expos. L1 22: 5+Expos. | | | | | | | | | | | | | | | | | | | | | |
| Costados [2] Sides [2] Joues [2] (mm) | 60 + 60 | | | | | | | | | | | | | | | | | | | | | |
| Puertas Doors Portes | 2 | 3 | 4 | 5 | | | | | | | | | | | | | | | | | | |
| Sistema de frío Cooling System Système de froid | Ventilado / Ventilated / Ventilé | | | | | | | | | | | | | | | | | | | | | |
| Desescarche Defrost Dégivrage | Automático / Automatic / Automatique | | | | | | | | | | | | | | | | | | | | | |
| Evaporación Evaporation Évaporation | Forzada / Forced / Ventilé | | | | | | | | | | | | | | | | | | | | | |
| Potencia Power Puissance (W) | - | | | | | | | | | | | | | | | | | | | | | |
| Potencia frig. Cooling capacity Puissance Frig. (W A -10°C) | L1: 1245 L1 22: 1336 | L1: 1865 L1 22: 2001 | L1: 2487 L1 22: 2668 | L1: 3108 L1 22: 3335 | | | | | | | | | | | | | | | | | | |
| Consumo Consumption Consommation (kWh/ 24h) | - | | | | | | | | | | | | | | | | | | | | | |
| Refrigerante Refrigerant Gaz | FREON | | | | | | | | | | | | | | | | | | | | | |
| Colores estándar Standar colors Couleurs standard | Int. Estándar / Standar / Standard Blanco/White/Blanc Negro/Black/Noir | | Laterales / Sides / Joues No Incluidos / Not includes / Non inclus | | | | | | | | | | | | | | | | | | | |
| Laterales disponibles Available sides Joues disponibles | Ext. Estándar / Standar / Standard <table border="1"> <tr> <td>Blanco/White/Blanc</td> <td>Ral 1015</td> <td>Ral 1018</td> </tr> <tr> <td>Ral 2003</td> <td>Ral 3003</td> <td>Ral 3020</td> </tr> <tr> <td>Ral 5015</td> <td>Ral 5017</td> <td>Ral 5011</td> </tr> <tr> <td>Ral 6002</td> <td>Ral 6018</td> <td>Ral 6019</td> </tr> <tr> <td>Ral 7035</td> <td>Ral 7037</td> <td>Ral 7042</td> </tr> <tr> <td>Ral 7016</td> <td>Ral 9006</td> <td>Negro/Black/Noir</td> </tr> </table> | | Blanco/White/Blanc | Ral 1015 | Ral 1018 | Ral 2003 | Ral 3003 | Ral 3020 | Ral 5015 | Ral 5017 | Ral 5011 | Ral 6002 | Ral 6018 | Ral 6019 | Ral 7035 | Ral 7037 | Ral 7042 | Ral 7016 | Ral 9006 | Negro/Black/Noir |  Lateral Espejo Mirror end panels Joue Miroir  Lateral Display Display end panels Joue Display | |
| Blanco/White/Blanc | Ral 1015 | Ral 1018 | | | | | | | | | | | | | | | | | | | | |
| Ral 2003 | Ral 3003 | Ral 3020 | | | | | | | | | | | | | | | | | | | | |
| Ral 5015 | Ral 5017 | Ral 5011 | | | | | | | | | | | | | | | | | | | | |
| Ral 6002 | Ral 6018 | Ral 6019 | | | | | | | | | | | | | | | | | | | | |
| Ral 7035 | Ral 7037 | Ral 7042 | | | | | | | | | | | | | | | | | | | | |
| Ral 7016 | Ral 9006 | Negro/Black/Noir | | | | | | | | | | | | | | | | | | | | |
| Opciones pág. 426-427 Options pages 426-427 Options pages 426-427 | | | | | | | | | | | | | | | | | | | | | | |

Serie / Series / Série **MBT (TORONTO)**

+Info: www.infrico.com

MF5P BT L1



MF5P BT22 L1

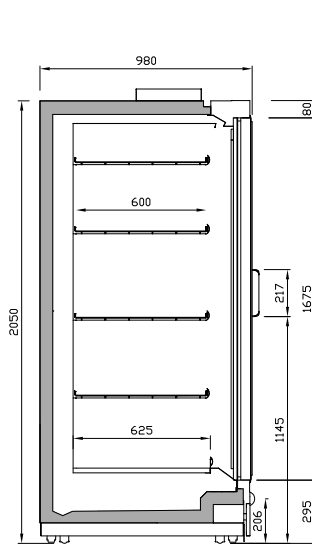

MF BT L1

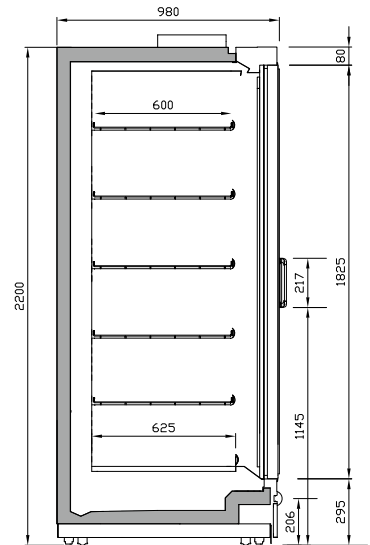

MF BT22 L1



Los datos técnicos están sujetos a posibles variaciones que serán actualizadas periódicamente en las fichas técnicas del producto, que están disponibles en el sitio web. / The technical data are subject to possible variations that will be updated periodically in the technical data sheets of the product, which are available on the company website. / Les données techniques peuvent varier et seront actualisées dans les fiches techniques du produit, disponibles sur le site web.

Mural mixta de congelación cerrada

Mixed freezer full glass doors multidecks

Murale mixte congélation fermée



MODELO
MODELE
MODÈLE



MN2P BTU L1

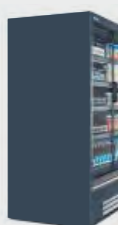

MN3P BTU L1

| Precio Price Prix | L1 | 8.184 € | 10.735 € | | | | | | | | | | | | | | | | | | | | |
|--|----------------------|--|-----------------------|------------------------|----------------------|------------------------|----------|----------|----------|----------|----------|----------|----------|----------|----------|----------|----------|----------|----------|----------|----------|----------|----------------------|
| Medidas / Measures / Mesures / [mm] Sin costados / Without sides / Sans joues | | 1562 x 780 x 2050 mm. | 2343 x 780 x 2050 mm. | | | | | | | | | | | | | | | | | | | | |
| T°. Prod. Aplic. Prod. T°. Applic. T°. [°C] Temp. Prod. Temp. Appliq. | | L1: -15/-18°C -23/-25°C | | | | | | | | | | | | | | | | | | | | | |
| Clase Climática Climatic class Classe climatique [°C] | | 3 / 25°C | | | | | | | | | | | | | | | | | | | | | |
| Tensión/Frecuencia Electrical data Tension électrique | | 230V/1ph/50Hz | | | | | | | | | | | | | | | | | | | | | |
| Controlador Controller Régulateur | | Digital | | | | | | | | | | | | | | | | | | | | | |
| Material Material Matériel [EXT/INT] | | Acero galvanizado plastificado / Plastified galvanised steel / Acier galvanisé plastifié | | | | | | | | | | | | | | | | | | | | | |
| Aislamiento Isolation Isolation [mm] | | 40kg/m ³ / Free CFC's / Zero ODP-GWP | | | | | | | | | | | | | | | | | | | | | |
| Capacidad Capacity Capacité [L] | | L1: 648 | L1: 973 | | | | | | | | | | | | | | | | | | | | |
| Área refrigerada Refrigerated area Zone réfrigérée [x m ²] | | L1: 3,16 | L1: 4,70 | | | | | | | | | | | | | | | | | | | | |
| Niveles Exposición Exposition Levels Niveaux d'exposition | | L1: 4+Expos. | | | | | | | | | | | | | | | | | | | | | |
| Costados [2] Sides [2] Joues [2] [mm] | | 60 + 60 | | | | | | | | | | | | | | | | | | | | | |
| Puertas Doors Portes | | 2 | 3 | | | | | | | | | | | | | | | | | | | | |
| Sistema de frío Cooling System Système de froid | | Ventilado / Ventilated / Ventilé | | | | | | | | | | | | | | | | | | | | | |
| Desescarche Defrost Dégivrage | | Automático / Automatic / Automatique | | | | | | | | | | | | | | | | | | | | | |
| Evaporación Evaporation Evaporation | | Forzada / Forced / Ventilé | | | | | | | | | | | | | | | | | | | | | |
| Potencia Power Puissance [W] | | 2043 | 3058 | | | | | | | | | | | | | | | | | | | | |
| Potencia frig. Cooling capacity Puissance Frig. [W A -10°C] | | - | - | | | | | | | | | | | | | | | | | | | | |
| Consumo Consumption Consommation [kWh/ 24h] | | 29,4 | 40,4 | | | | | | | | | | | | | | | | | | | | |
| Refrigerante Refrigerant Gaz | | R-290 | | | | | | | | | | | | | | | | | | | | | |
| Colores estándar Standar colors Couleurs standard | | <p>Int. Estándar / Standar / Standard</p> <table border="1"> <tr> <td>Blanco/White/ Blanc</td> <td>Negro/Black/ Noir</td> </tr> </table> <p>Ext. Estándar / Standar / Standard</p> <table border="1"> <tr> <td>Blanco/White/ Blanc</td> <td>Ral 1015</td> <td>Ral 1018</td> </tr> <tr> <td>Ral 2003</td> <td>Ral 3003</td> <td>Ral 3020</td> </tr> <tr> <td>Ral 5015</td> <td>Ral 5017</td> <td>Ral 5011</td> </tr> <tr> <td>Ral 6002</td> <td>Ral 6018</td> <td>Ral 6019</td> </tr> <tr> <td>Ral 7035</td> <td>Ral 7037</td> <td>Ral 7042</td> </tr> <tr> <td>Ral 7016</td> <td>Ral 9006</td> <td>Negro/Black/ Noir</td> </tr> </table> | | Blanco/White/ Blanc | Negro/Black/ Noir | Blanco/White/ Blanc | Ral 1015 | Ral 1018 | Ral 2003 | Ral 3003 | Ral 3020 | Ral 5015 | Ral 5017 | Ral 5011 | Ral 6002 | Ral 6018 | Ral 6019 | Ral 7035 | Ral 7037 | Ral 7042 | Ral 7016 | Ral 9006 | Negro/Black/ Noir |
| Blanco/White/ Blanc | Negro/Black/ Noir | | | | | | | | | | | | | | | | | | | | | | |
| Blanco/White/ Blanc | Ral 1015 | Ral 1018 | | | | | | | | | | | | | | | | | | | | | |
| Ral 2003 | Ral 3003 | Ral 3020 | | | | | | | | | | | | | | | | | | | | | |
| Ral 5015 | Ral 5017 | Ral 5011 | | | | | | | | | | | | | | | | | | | | | |
| Ral 6002 | Ral 6018 | Ral 6019 | | | | | | | | | | | | | | | | | | | | | |
| Ral 7035 | Ral 7037 | Ral 7042 | | | | | | | | | | | | | | | | | | | | | |
| Ral 7016 | Ral 9006 | Negro/Black/ Noir | | | | | | | | | | | | | | | | | | | | | |
| Laterales disponibles Available sides Joues disponibles | | <p>Laterales / Sides / Joues</p> <p>No Incluidos / Not includes / Non inclus</p>  <p>Lateral Espejo Mirror end panels Joue Miroir</p> | | | | | | | | | | | | | | | | | | | | | |
| Opciones pág. 426-427 Options pages 426-427 Options pages 426-427 | | | | | | | | | | | | | | | | | | | | | | | |

Serie / Series / Série **MBTU (MONTREAL)**

+Info: www.infrico.com



MN3P BTU L1

Estantes profundidad 400mm
Shelves 400mm depth
Profondeur des étagères 400mm

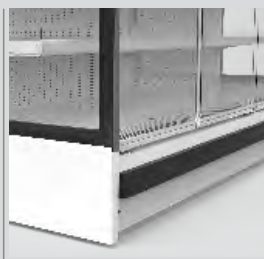

Nuevo paragolpes frontal

New front bumper

Nouveau pare-chocs frontale

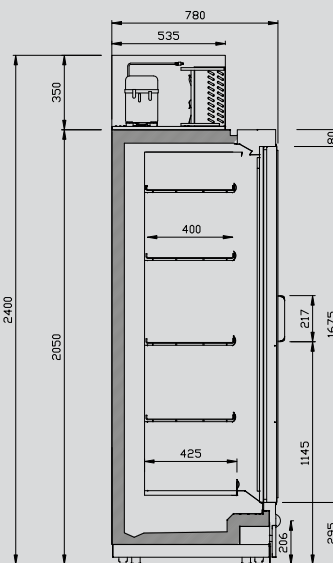





Mural plug in de congelación cerradas

Plug in freezer full glass doors multidecks

Murale de congélation fermée groupe incorporé



| MODELO MODELE MODÈLE |  |  |  | | | | | | | | | | | | | | | | | | | | |
|--|--|---|---|------------------------|----------------------|------------------------|----------|----------|----------|----------|----------|----------|----------|----------|----------|----------|----------|----------|----------|----------|----------|----------|----------------------|
| Precio Price Prix | L1 | 6.613 € | 8.753 € | 10.631 € | | | | | | | | | | | | | | | | | | | |
| MOD. | MN12 BTPC L1 | MN18 BTPC L1 | MN25 BTPC L1 | | | | | | | | | | | | | | | | | | | | |
| Precio Price Prix | C L1 | 6.754 € | 8.937 € | 10.853 € | | | | | | | | | | | | | | | | | | | |
| Medidas Measures [mm] Mesures | 1250 x 780 x 2000 mm. | 1835 x 780 x 2000 mm. | 2500 x 780 x 2000 mm. | | | | | | | | | | | | | | | | | | | | |
| T°. Prod. Aplic. Prod. T°. Applic. T°. [°C] Temp. Prod. Temp. Appliq. | L1: -15/-18°C -23/-25°C | | | | | | | | | | | | | | | | | | | | | | |
| Clase Climática Climatic class Classe climatique [°C] | 3 / 25°C | | | | | | | | | | | | | | | | | | | | | | |
| Tensión/Frecuencia Electrical data Tension électrique | 230V/1ph/50Hz | | | | | | | | | | | | | | | | | | | | | | |
| Controlador Controller Régulateur | Digital | | | | | | | | | | | | | | | | | | | | | | |
| Material Material [EXT/INT] Matériel | Acero galvanizado plastificado / Plastified galvanised steel / Acier galvanisé plastifié | | | | | | | | | | | | | | | | | | | | | | |
| Aislamiento Isolation [mm] Isolation | 40kg/m ³ / Free CFC's / Zero ODP-GWP | | | | | | | | | | | | | | | | | | | | | | |
| Capacidad Capacity [L] Capacité | 664 | 996 | 1328 | | | | | | | | | | | | | | | | | | | | |
| Área refrigerada Refrigerated area [x m ²] Zone réfrigérée | 2,54 | 3,81 | 5,08 | | | | | | | | | | | | | | | | | | | | |
| Niveles Exposición Exposition Levels Niveaux d'exposition | 4+Expos. | | | | | | | | | | | | | | | | | | | | | | |
| Costados [2] Sides [2] Joues [2] [mm] | 60 + 60 | | | | | | | | | | | | | | | | | | | | | | |
| Puertas Doors Portes | 2 | 3 | 4 | | | | | | | | | | | | | | | | | | | | |
| Sistema de frío Cooling System Système de froid | Ventilado / Ventilated / Ventilé | | | | | | | | | | | | | | | | | | | | | | |
| Desescarche Defrost Dégivrage | Automático / Automatic / Automatique | | | | | | | | | | | | | | | | | | | | | | |
| Evaporación Evaporation Évaporation | Forzada / Forced / Ventilé | | | | | | | | | | | | | | | | | | | | | | |
| Potencia Power [W] Puissance | 1282 | 1695 | 2512 | | | | | | | | | | | | | | | | | | | | |
| Potencia frig. Cooling capacity [W A -10°C] Puissance Frig. | - | - | - | | | | | | | | | | | | | | | | | | | | |
| Consumo Consumption [kWh/ 24h] Consommation | 23,1 | 30,5 | 45,2 | | | | | | | | | | | | | | | | | | | | |
| Refrigerante Refrigerant Gaz | R-290 | | | | | | | | | | | | | | | | | | | | | | |
| Colores estándar Standar colors Couleurs standard | <p>Int. Estándar / Standar / Standard</p> <table border="1"> <tr> <td>Blanco/White/ Blanc</td> <td>Negro/Black/ Noir</td> </tr> </table> <p>Ext. Estándar / Standar / Standard</p> <table border="1"> <tr> <td>Blanco/White/ Blanc</td> <td>Ral 1015</td> <td>Ral 1018</td> </tr> <tr> <td>Ral 2003</td> <td>Ral 3003</td> <td>Ral 3020</td> </tr> <tr> <td>Ral 5015</td> <td>Ral 5017</td> <td>Ral 5011</td> </tr> <tr> <td>Ral 6002</td> <td>Ral 6018</td> <td>Ral 6019</td> </tr> <tr> <td>Ral 7035</td> <td>Ral 7037</td> <td>Ral 7042</td> </tr> <tr> <td>Ral 7016</td> <td>Ral 9006</td> <td>Negro/Black/ Noir</td> </tr> </table> | | | Blanco/White/ Blanc | Negro/Black/ Noir | Blanco/White/ Blanc | Ral 1015 | Ral 1018 | Ral 2003 | Ral 3003 | Ral 3020 | Ral 5015 | Ral 5017 | Ral 5011 | Ral 6002 | Ral 6018 | Ral 6019 | Ral 7035 | Ral 7037 | Ral 7042 | Ral 7016 | Ral 9006 | Negro/Black/ Noir |
| Blanco/White/ Blanc | Negro/Black/ Noir | | | | | | | | | | | | | | | | | | | | | | |
| Blanco/White/ Blanc | Ral 1015 | Ral 1018 | | | | | | | | | | | | | | | | | | | | | |
| Ral 2003 | Ral 3003 | Ral 3020 | | | | | | | | | | | | | | | | | | | | | |
| Ral 5015 | Ral 5017 | Ral 5011 | | | | | | | | | | | | | | | | | | | | | |
| Ral 6002 | Ral 6018 | Ral 6019 | | | | | | | | | | | | | | | | | | | | | |
| Ral 7035 | Ral 7037 | Ral 7042 | | | | | | | | | | | | | | | | | | | | | |
| Ral 7016 | Ral 9006 | Negro/Black/ Noir | | | | | | | | | | | | | | | | | | | | | |
| Laterales disponibles Available sides Joues disponibles | <p>Laterales / Sides / Joues</p> <p>No Incluidos / Not includes / Non inclus</p> <div style="display: flex; justify-content: space-around;"> <div style="text-align: center;">  Lateral Espejo Mirror end panels Joue Miroir </div> <div style="text-align: center;">  Lateral Display Display end panels Joue Display </div> </div> | | | | | | | | | | | | | | | | | | | | | | |
| Opciones pág. 426-427 Options pages 426-427 Options pages 426-427 | | | | | | | | | | | | | | | | | | | | | | | |

Serie / Series / Série **MBTP (VANCOUVER)**

+Info: www.infrico.com

MN25 BTP L1



Estantes profundidad 400mm
Shelves 400mm depth
Profondeur des étagères 400mm



**Nuevo
paragolpes
frontal**

**New
front
bumper**

**Nouveau
pare-chocs
frontale**



MN12 BTP L1



MN18 BTP L1

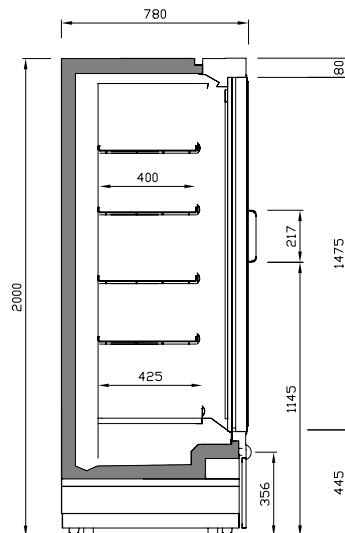

MN BTP L1



Opciones / Options / Options

Colores fuera de carta (epoxi) x mueble / non-standard colours (epoxy) per unit / couleurs hors palette (epoxi) x meuble

| | |
|--|----------|
| Exterior / Exterior / Extérieure | 817,00 € |
| Interior RAL Infrico Supermarket excepto blanco, negro y gris antracita [7016] / RAL Infrico Supermarket interior except black, white and anthracite grey [7016] / Intérieure RAL Infrico Supermarket sauf noir, blanc et gris anthracite [7016] | 509,00 € |

Semimurales grupo incorporado / Plug In low multidecks / Semi murales groupe Incorporé

| General General Général | Led cornisa RT Led canopy RT Led corniche RT (carne / meat / viande) | Led estante (línea) Shelf led (line) Led étagère (ligne) 4000k/2700K | Led estante RT carne Shelf led RT meat Led étagère RT viande (línea / line / ligne) | Lateral espejo Mirror end wall Joue miroir | Lateral display Display end wall Joue display | Frente estante metacr. Methacr. shelf front Étagère frontale méthac. |
|-------------------------------|---|---|--|--|---|--|
| SMS/SML6 | 12,00 € | 77,00 € | 83,00 € | 313,00 € | 325,00 € | - € |
| SMS/SML9 | 19,00 € | 81,00 € | 88,00 € | 313,00 € | 325,00 € | 19,00 € |
| SMS/SML12 | 25,00 € | 84,00 € | 91,00 € | 313,00 € | 325,00 € | 20,00 € |
| SMS/SML18 | 36,00 € | 153,00 € | 165,00 € | 313,00 € | 325,00 € | 38,00 € |
| SMS/SML25 | 50,00 € | 157,00 € | 170,00 € | 313,00 € | 325,00 € | 40,00 € |

Semimurales grupo remoto / Remote group low multidecks / Semi murales groupe à distance

| General General Général | Led cornisa RT Led canopy RT Led corniche RT (carne / meat / viande) | Led estante (línea) Shelf led (line) Led étagère (ligne) 4000k/2700K | Led estante RT carne Shelf led RT meat Led étagère RT viande (línea / line / ligne) |
|-------------------------------|---|---|--|
| SML12 | 25,00 € | 84,00 € | 91,00 € |
| SML18 | 36,00 € | 153,00 € | 165,00 € |
| SML25 | 53,00 € | 157,00 € | 170,00 € |
| SML37 | 84,00 € | 226,00 € | 244,00 € |

| General General Général | Lateral espejo Mirror side end Joue miroir | Lateral panorámico Panoramic side end Joue panoramique | Lateral display Display side end Joue display | Frente estante metacrilato Methacrylate shelf front Étagère frontale méthacrylate |
|-------------------------------|--|--|---|---|
| SML12 | 140,00 € | 391,00 € | 255,00 € | 20,00 € |
| SML18 | 140,00 € | 391,00 € | 255,00 € | 38,00 € |
| SML25 | 140,00 € | 391,00 € | 255,00 € | 40,00 € |
| SML37 | 140,00 € | 391,00 € | 255,00 € | 60,00 € |

Murales grupo incorporado / Plug In multidecks / Murales groupe incorporé

| General General Général | Lateral espejo Mirror side end Joue miroir | Lateral espejo Inox Mirror side end Inox Joue miroir Inox | Lateral display Display end wall Joue display | Lateral display Inox Display side end Inox Joue display Inox | Separador central espejo Central mirror divider Séparateur central miroir |
|-------------------------------|--|---|---|--|---|
| MS | 216,00 € | 402,00 € | 304,00 € | 533,00 € | 288,00 € |
| MN | 228,00 € | 546,00 € | 313,00 € | 593,00 € | 341,00 € |
| ML | 242,00 € | 637,00 € | 325,00 € | 653,00 € | 362,00 € |

| General General Général | SCC Sist. Condens. Cristal SCC Condens. glass system SCC Syst. condens. vitre | Frente estante metacrilato Methacrylate shelf front Étagère frontale méthacrylate | MS Línea estante 300 MS Shelf line 300 Ligne étagère MS 300 | MN/ML Línea estante 400 MN/ML Shelf line 400 Ligne étagère MN/ML 400 |
|-------------------------------|---|---|---|--|
| MS/MN/ML6 | 76,00 € | - € | +5% +10% | 40,00 € |
| MS/MN/ML9 | 79,00 € | 19,00 € | +5% +10% | 101,00 € |
| MS/MN/ML12 | 79,00 € | 20,00 € | +5% +10% | 109,00 € |
| MS/MN/ML18 | 114,00 € | 38,00 € | +5% +10% | 202,00 € |
| MS/MN/ML25 | 114,00 € | 40,00 € | +5% +10% | 217,00 € |

| Iluminación Lighting Éclairage | Led cornisa RT Led canopy RT Led corniche RT (carne / meat / viande) | Led estante (línea) Shelf led (line) Led étagère (ligne) 4000k/2700K | Led estante RT carne Shelf led RT meat Led étagère RT viande (línea / line / ligne) | Led vertical 4000K Vertical led 4000K Led vertical 4000K | Led vertical 2700K Vertical led 2700K Led vertical 2700K | Led vertical RT Vertical led RT Led vertical RT (carne / meat / viande) |
|--------------------------------------|---|---|--|--|--|--|
| MS/MN/ML6 | 12,00 € | 77,00 € | 83,00 € | 214,00 € | 214,00 € | 224,00 € |
| MS/MN/ML9 | 19,00 € | 81,00 € | 88,00 € | 214,00 € | 214,00 € | 224,00 € |
| MS/MN/ML12 | 25,00 € | 84,00 € | 91,00 € | 214,00 € | 214,00 € | 224,00 € |
| MS/MN/ML18 | 36,00 € | 153,00 € | 165,00 € | 294,00 € | 294,00 € | 312,00 € |
| MS/MN/ML25 | 50,00 € | 188,00 € | 170,00 € | 294,00 € | 294,00 € | 312,00 € |

Murales grupo remoto / Remote multidecks / Murales groupe remote

| Lateral/Separador Side end/ Divider Joues/Séparateur | Lateral panorámico Panoramic side end Joue panoramique | Lateral Display Display side end Joue Display | Lateral espejo Mirror side end Joue miroir | Separador central Central divider Séparateur central | Separador fijo metacrilato Methacrylate fixed divider Séparateur fixe méthacrylate |
|--|--|---|---|---|--|
| MS | 434,00 € | 355,00 € | 257,00 € | 377,00 € | 123,00 € |
| MN | 446,00 € | 362,00 € | 262,00 € | 343,00 € | 185,00 € |
| MN22 | 456,00 € | 384,00 € | 286,00 € | 380,00 € | 196,00 € |
| ML | 453,00 € | 377,00 € | 290,00 € | 371,00 € | 196,00 € |
| ML22 | 498,00 € | 392,00 € | 312,00 € | 393,00 € | 208,00 € |
| MX | 553,00 € | 453,00 € | 324,00 € | 492,00 € | 210,00 € |
| MX22 | 582,00 € | 461,00 € | 344,00 € | 527,00 € | 224,00 € |
| General General Général | Kit espejo Mirror kit Kit miroir | Línea estante 400 Shelf line 400 Étagère 400 | Línea estante 450 Shelf line 450 Ligne étagère 450 | Línea estante 500 Shelf line 500 Ligne étagère 500 | Línea estante 600 Shelf line 600 Ligne étagère 600 |
| MS/MN/ML/MX9 | 98,00 € | 109,00 € | 110,00 € | 114,00 € | 138,00 € |
| MS/MN/ML/MX12 | 112,00 € | 119,00 € | 120,00 € | 135,00 € | 167,00 € |
| MS/MN/ML/MX18 | 196,00 € | 217,00 € | 219,00 € | 227,00 € | 276,00 € |
| MS/MN/ML/MX25 | 223,00 € | 238,00 € | 240,00 € | 269,00 € | 334,00 € |
| MS/MN/ML/MX31 | 307,00 € | 335,00 € | 339,00 € | 362,00 € | 443,00 € |
| MS/MN/ML/MX37 | 334,00 € | 356,00 € | 360,00 € | 404,00 € | 501,00 € |

| General General Général | SCC Sist. Condens. Cristal SCC Condens. glass system SCC Syst. condens. vitre | Frente estante metacrilato Methacrylate shelf front Étagère frontale méthacrylate | Ventiladores elect. Electronic fan Ventilateurs élect. | Control elect. Electronic control Control élect. | Termómetro Thermometer Thermomètre | Salida tubos sup. Top tube output Sortie tube sup. |
|-------------------------------|---|---|--|--|--|--|
| MS/MN/ML/MX9 | - | 19,00 € | 45,00 € | de serie | de serie | de serie |
| MS/MN/ML/MX12 | 79,00 € | 20,00 € | 88,00 € | de serie | de serie | de serie |
| MS/MN/ML/MX18 | 114,00 € | 38,00 € | 132,00 € | de serie | de serie | de serie |
| MS/MN/ML/MX25 | 114,00 € | 40,00 € | 175,00 € | de serie | de serie | de serie |
| MS/MN/ML/MX31 | 165,00 € | 58,00 € | 219,00 € | de serie | de serie | de serie |
| MS/MN/ML/MX37 | 165,00 € | 60,00 € | 262,00 € | de serie | de serie | de serie |

| Iluminación Lighting Éclairage | Led cornisa RT Led canopy RT Led corniche RT (carne / meat / viande) | Led estante (línea) Shelf led (line) Led étagère (ligne) 4000k/2700K | Led estante RT carne Shelf led RT meat Led étagère RT viande (línea / line / ligne) | Led vertical 4000K Vertical led 4000K Led vertical 4000K | Led vertical 2700K Vertical led 2700K Led vertical 2700K | Led vertical RT Vertical led RT Led vertical RT (carne / meat / viande) |
|--------------------------------------|---|---|--|--|--|--|
| MS/MN/ML/MX9 | 19,00 € | 81,00 € | 88,00 € | - | - | - |
| MS/MN/ML/MX12 | 25,00 € | 84,00 € | 91,00 € | 233,00 € | 233,00 € | 244,00 € |
| MS/MN/ML/MX18 | 36,00 € | 153,00 € | 165,00 € | 327,00 € | 327,00 € | 344,00 € |
| MS/MN/ML/MX25 | 50,00 € | 157,00 € | 170,00 € | 327,00 € | 327,00 € | 344,00 € |
| MS/MN/ML/MX31 | 74,00 € | 224,00 € | 242,00 € | 439,00 € | 439,00 € | 461,00 € |
| MS/MN/ML/MX37 | 84,00 € | 226,00 € | 244,00 € | 439,00 € | 439,00 € | 461,00 € |

Murales Congelación grupo incorp. MBTP / Plug In freezer multidecks MBTP / Murales congélation groupe inc. MBTP

| | Lateral Display Display side end Joue Display | Lateral Opaco Opaque side end Joue opaque | Separador central Central divider Séparateur central | Separador fijo metacrilato Methacrylate fixed divider Séparateur fixe méthacrylate |
|-------|---|---|--|--|
| MNBTP | 393,00 | 219,00 | 231,00 | 131,00 |

Murales Congelación grupo remoto MBT-MBTU / Freezer multidecks MBT-MBTU / Murales congélation groupe à dist. MBT-MBTU

| | Lateral Opaco Opaque side end Joue Opaque | Lateral Display Display side end Joue Display | Separador fijo metacrilato Methacrylate fixed divider Séparateur fixe méthacrylate | Ventiladores alta efic. 1 x puerta High efficiency fans 1 x door Ventilateurs haut rendem. 1 x porte | Separador central Central divider Séparateur central | Voltajes especiales Special voltages Tension élect. spéciale |
|------|---|---|--|---|--|--|
| MN | 248,00 € | - | Consultar disponibilidad / Check availability / Vérifier la disponibilité | | | Consultar/ Consult/ Consulter |
| MN22 | 253,00 € | - | Consultar disponibilidad / Check availability / Vérifier la disponibilité | | | |
| MF | 253,00 € | 582,00 € | 231,00 € | 47,00 € | 262,00 € | |
| MF22 | 259,00 € | 594,00 € | 256,00 € | 47,00 € | 273,00 € | |

Válvula termostática / Thermostatic valve / Vanne thermostatique

| | | | |
|--------------|--------------|--------------|--|
| R404a 0,00 € | R410a 0,00 € | R513a 0,00 € | Electrónica Electronic 561,00 € Electronique |
| R507a 0,00 € | R134a 0,00 € | R449a 0,00 € | |



Unidades motocondensadoras Condensing units Motocondensateurs

SIGILUS

Unidades motocondensadoras compactas en construcción silenciosa y motoventilador axial.

Refrigerante R449 A o R134a, o refrigerantes alternativos.

Compresor hermético alternativo, montado sobre amortiguadores, con silenciador de descarga, resistencia de cárter y clixon interno.

Batería condensadora de amplia superficie, de tubos de cobre y aletas de aluminio, con dimensionamiento tropicalizado para temperatura ambiente de hasta 50 °C.

Motoventilador axial de bajas revoluciones.

Control proporcional de presión de condensación mediante variación de velocidad del motoventilador.

Circuito frigorífico equipado con presostatos de alta y baja presión, filtro cerámico, recipiente y visor de líquido.

Air-cooled packaged condensing units in a low-noise axial construction in mechanical, and multiservice versions.

R134a or R449A refrigerant or alternative refrigerants.

Reciprocating hermetic or scroll compressor, acoustically insulated, with discharge muffler, mounted on shock absorbers, with internal klixon and crankcase heater.

Large surface condenser coil, copper pipes and aluminum fins, tropicalised for ambient temperature up to 50 °C.

Low rpm motor fans, mounted on nozzles dynamically balanced propellers and external protection grilles.

Variable speed axial fan for proportional condensation pressure control.

Refrigeration circuit equipped with high and low pressure switches, ceramic filter and sight gauge.

Unité de condensation silencieuse et motoventilateur.

Gaz réfrigérant R449, R134a.

Compresseur hermétique alternatif, monté sur amortisseurs, silencieux de refoulement, résistance de carter et klixon interne.

Batterie de condensation de grande surface d'échange de tubes de cuivre et ailettes en aluminium avec dimensionnement tropicalisé pour température ambiante jusqu'à 50°C.

Motoventilateur à basse vitesse.

Contrôle modulant de la pression de condensation par variation de la vitesse du motoventilateur.

Circuit frigorifique équipé avec pressostats de haute et basse pression, filtre céramique, récipient et viseur de liquide.



Serie / Series / Série SIGILUS / INTARBOX

INTARBOX

Unidades motocondensadoras compactas en construcción horizontal y motoventilador axial o centrífugo.

Refrigerante R449 A o R134a, o refrigerantes alternativos.

Compresor hermético alternativo, montado sobre amortiguadores, con silenciador de descarga y clixon interno.

Batería condensadora de tubos de cobre y aletas de aluminio.

Turbina centrífuga con presión estática disponible para la conducción del aire de condensación (versión centrífuga).

Circuito frigorífico equipado con presostatos de alta y baja presión, filtro cerámico, recipiente y visor de líquido.

Control digital de presión de condensación en versiones -N, y control de condensación todo-nada en versiones -M.

Control proporcional de presión de condensación mediante variación de velocidad del motoventilador (incluido a partir de MDH serie 4 y 5).

Cuadro eléctrico de potencia y maniobra, con protección de compresor y motoventilador.

Air-cooled packaged condensing units with axial or centrifugal fan.

R134a or R449A refrigerant or alternative refrigerants.

Hermetic reciprocating compressor mounted on shock absorbers, with discharge muffler and internal klixon.

High performance condensing coil in copper pipes and aluminium fins.

Centrifugal motor fan with available static pressure for a ducted outlet of condenser hot air (centrifugal version).

Refrigeration circuit equipped with HP and LP switches, filter dryer, liquid receiver and sight gauge.

Digital control of condensing pressure (version N) and on/off control of condensing pressure (version M).

Proportional control of condensing pressure through fan speed variation (version N series 4 and 5).

Full control and power board with compressor and motor fan protection.

Unités moto-condenseurs et motoventilateur centrifuge.

Réfrigérant R449, R134a ou réfrigérants alternatives.

Compresseur hermétique alternatif, monté sur amortisseurs, silencieux de refoulement et klixon interne.

Batterie de condensation à tubes de cuivre et d'ailettes en aluminium.

Motoventilateur centrifuge avec pression statique disponible pour le gainage de l'air de condensation.

Circuit frigorifique équipé de pressostats d'haute et basse pression filtre céramique, bouteille et voyant de liquide.

Contrôle digital de la pression de condensation en version -N et contrôle de la pression de condensation tout-rien -M.

Contrôle proportionnel de la pression de condensation par variation de vitesse du motoventilateur (à partir de MDH séries 4).

Cadre électrique de puissance et manœuvre avec protection de compresseur et motoventilateur.



Unidades multiservicio con sistema VRC

Multiservice units VRC system

Version multiservice avec système VRC

+Info: www.infrico.com

Estructura

Válvula presostática de aspiración [VP].
 Válvula presostática de by-pass [VC].
 Válvula termostática de inyección de líquido [VE].
 Presostato de control [IP].
 Separador de aceite.

El sistema VRC aplicado a un compresor hermético alternativo adapta el flujo de refrigerante a la demanda de las unidades evaporadoras manteniendo constante la presión en la línea de aspiración.

El sistema VRC se compone de un juego de válvulas de regulación de presión y temperatura capaces de variar de forma progresiva la capacidad frigorífica de un compresor entre un 100% y un 10% de su potencia nominal, a la vez que se reduce la potencia eléctrica absorbida y se protege el compresor al mantener su relación de compresión dentro de los márgenes de seguridad, evitando el riesgo de sobrecalentamiento.

Versión horizontal centrífuga o axial multiservicio Intarbox-multi: series MDH-CV/-V.
 Versión horizontal axial silenciosa multiservicio Siligus-multi: series MDF-V.

Estructure

Suction pressure valve [VP].
 By-pass pressure valve [VC].
 Thermostatic expansion valve for liquid injection [VE].
 Pressure control switch [IP].
 Oil separator.

The VRC system applied to a reciprocating hermetic compressor adjusts the flow of refrigerant to the evaporator unit's demand by maintaining constant pressure in the suction line.

The VRC system is composed of a set of pressure and temperature valves capable of progressive variation of a compressor's cooling capacity between 100% and 10% of this rated power, at the same time the system reduces electrical input power and protects the compressor, maintaining its compression ratio within security margins, eliminating the risk of overheating.
 Intarbox horizontal axial or centrifugal for several services Series MDH-CV/-V.
 Sigilus low-noise axial for several services.

Structure

Vanne pressostatique d'aspiration [VP].
 Vanne pressostatique de by-pass [VC].
 Détendeur thermostatique d'injection de liquide [VE].
 Pressostat de contrôle [IP].
 Séparateur d'huile.

Le système VRC à un seul compresseur hermétique à piston adapte le flux du gaz à la demande des unités d'évaporation, en maintenant de manière constante la pression de la ligne d'aspiration.

Le système VRC est constitué par un ensemble de vannes de régulation de pression et de température qui peuvent varier progressivement la capacité frigorifique du compresseur de 100% jusqu'à 10% de sa puissance nominale, tout en réduisant la puissance électrique absorbée et en protection du compresseur par maintenir son fonctionnement dans les marges de sécurité afin d'éviter le risque de surchauffage.

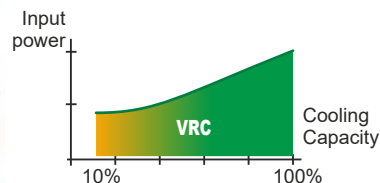
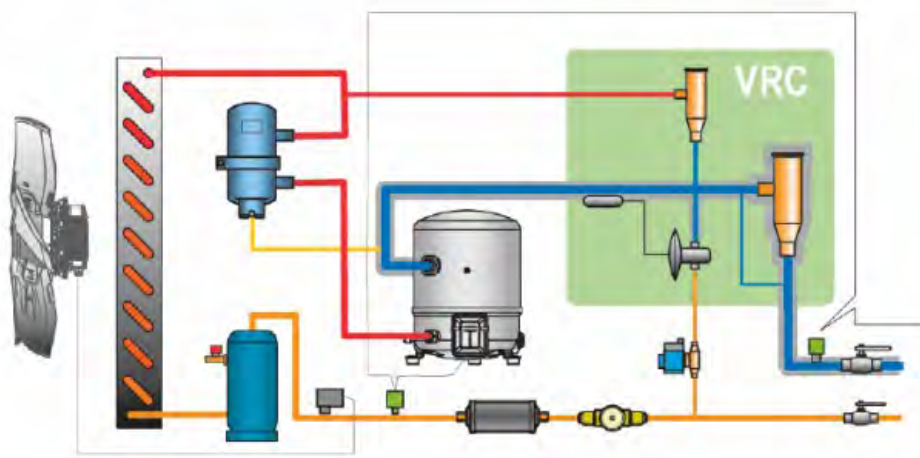

Ejemplo instalación multiservicio

Multiservice installation

Exemple d'installation multiservice

Los equipos en versión multiservicio están diseñados para centralizar la producción frigorífica de un conjunto de unidades evaporadoras.

Multi-service condensing units are specifically designed for cooling production centralization of a set of positive or negative temperature evaporating units.

Les unités motocondensateurs à système VRC, permettent de centraliser la production frigorifique d'un ensemble de services, en maintenant de manière constante la pression et température du gaz dans les évaporateurs.

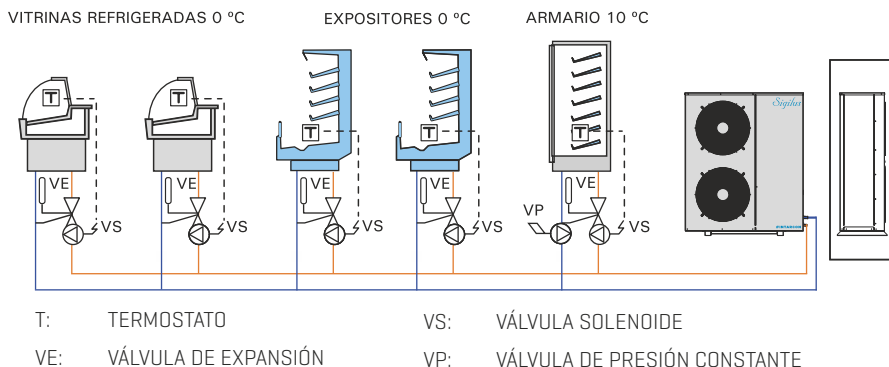

Los datos técnicos están sujetos a posibles variaciones que serán actualizadas periódicamente en las fichas técnicas del producto, disponibles en la web /
 The technical data are subject to possible variations that will be updated periodically in the technical data sheets of the product, which are available on the website /
 Les données techniques peuvent varier et seront actualisées dans les fiches techniques du produit, disponibles sur le site web.

Motocondensadoras

Condensing units

Motocondensateurs

Opciones / Options / Options

| | Precio Price (€) Prix |
|--|-----------------------------|
| Cambio a alimentación 400 V-III-50 Hz | + 8 % |
| Separador de aceite [ya incluido en versiones -V] | 716 € |
| Válvula solenoide integrada con cuerpo y bobina [sólo en versiones -N y -M] | 178 € |
| Recubrimiento anticorrosión de batería | + 8 % |
| Rejilla exterior de protección de batería | 112 € |
| Control de condensación proporcional por variación de velocidad del motoventilador [Serie 1 monofásicos] | 304 € |
| Versión electrónica | +5 % |



230 V-I-50 Hz / 400 V-III-50 Hz | R134a - R449A | Media temperatura 1 o 2 servicios /

| REFRIGERANTE | SERIE / MODELO SERIES / MODEL SÉRIES / MODÈLE | COMPRESOR COMPRESSOR COMPRESSEUR | | POTENCIA FRIGORÍF. POWER PUISSANCE FRIGORIF. EN13215 (W) ⁽¹⁾ T° EVAP. -35 °C | POT. FRIGOR./POWER/PUISSANCE FRIGORIF. (W) ⁽²⁾ TEMP. EVAPORAC./EVAPORATION TEMP./TEMP. D'ÉVAPOR. | | | | POTEN.ABSOR. NOMINAL NOMINAL POW. ABSOR. PUISS.ABSORC. NOMINALE (kW) | [C.O.P.] S.E.P.R. ⁽³⁾ | INTENS. MÁX. ABSORCIÓN MAX. ABSOR. POWER INTENS. MAX. ABSOR. (A) | VENTILADOR FAN VENTILATEUR Ø mm | CAUDAL FLOW RATE DÉBIT D'AIR (m³/h) | CONEXIÓN FRIGORÍFICA COOLING CONNECTION CONNECTION FRIGORIFIQUE LIQ - GAS | PESO WEIGHT POIDS (kg) | NIVEL PRES. SONORA PRESS.LEVEL NIVEAU PRESS. SONORE dB(A) ⁽⁶⁾ | PVP PRICE PVP (€) |
|--------------|---|--|-----------|--|--|-------|--------|--------|--|-------------------------------------|---|--|--|---|---------------------------------|---|----------------------------|
| | | CV | TENSIÓN | | 0 °C | -5 °C | -10 °C | -15 °C | | | | | | | | | |
| R134a | MDF-MY-0 010 | 3/8 | 230 V-I | 570 | 880 | 710 | 560 | 430 | 0,33 | [1,75] | 4 | Ø 200 | 350 | 1/4"-3/8" | 50 | 28 | 1.916 |
| | MDF-MY-0 015 | 1/2 | 230 V-I | 795 | 1 200 | 975 | 775 | 595 | 0,46 | [1,73] | 5 | Ø 200 | 350 | 1/4"-3/8" | 52 | 29 | 2.044 |
| | MDF-MY-1 015 | 1/2 | 230 V-I | 875 | 1 395 | 1 110 | 865 | 650 | 0,49 | [1,78] | 5 | Ø 360 | 1 700 | 1/4"-1/2" | 66 | 31 | 2.158 |
| | MDF-MY-1 026 | 3/4 | 230 V-I | 1 340 | 2 160 | 1 710 | 1 315 | 980 | 0,71 | [1,89] | 9 | Ø 360 | 1 700 | 1/4"-1/2" | 74 | 31 | 2.300 |
| | MDF-MY-1 033 | 1 | 230 V-I | 1 780 | 2 700 | 2 160 | 1 685 | 1 280 | 0,82 | [2,11] | 9 | Ø 360 | 1 700 | 1/4"-5/8" | 76 | 31 | 2.618 |
| | MDF-MY-1 053 | 1 1/2 | 230 V-I * | 2 425 | 3 975 | 3 115 | 2 360 | 1 710 | 1,04 | [2,33] | 12 | Ø 360 | 1 700 | 1/4"-3/4" | 88 | 32 | 3.103 |
| | MDF-MY-1 074 | 2 | 230 V-I * | 3 150 | 5 080 | 4 005 | 3 045 | 2 210 | 1,37 | [2,29] | 16 | Ø 360 | 1 700 | 1/4"-3/4" | 90 | 36 | 3.905 |
| | MDF-MY-2 086 | 4 | 400 V-III | 4 230 | 6 800 | 5 360 | 4 130 | 3 090 | 1,84 | [2,32] | 13 | Ø 450 | 3 600 | 3/8"-7/8" | 98 | 39 | 4.383 |
| | MDF-MY-2 108 | 5 | 400 V-III | 5 175 | 8 280 | 6 535 | 5 035 | 3 765 | 2,23 | [3,23] | 16 | Ø 450 | 3 600 | 3/8"-7/8" | 100 | 38 | 4.645 |
| | MDF-MY-2 136 | 6 1/2 | 400 V-III | 6 575 | 10 140 | 8 200 | 6 385 | 4 835 | 2,99 | [2,87] | 19 | Ø 450 | 3 600 | 3/8"-1 1/8" | 103 | 34 | 5.327 |
| R449A | MDF-MG-0 008 | 1/3 | 230 V-I | 570 | 965 | 790 | 635 | 490 | 0,36 | [1,71] | 4 | Ø 200 | 350 | 1/4"-3/8" | 51 | 28 | 1.804 |
| | MDF-MG-0 010 | 3/8 | 230 V-I | 735 | 1 210 | 1 000 | 805 | 635 | 0,46 | [1,72] | 5 | Ø 200 | 350 | 1/4"-3/8" | 51 | 29 | 1.925 |
| | MDF-MG-0 012 | 1/2 | 230 V-I | 870 | 1 395 | 1 160 | 945 | 755 | 0,54 | [1,74] | 6 | Ø 200 | 350 | 1/4"-3/8" | 51 | 29 | 2.035 |
| | MDF-MG-1 014 | 1/2 | 230 V-I | 1 075 | 1 870 | 1 515 | 1 200 | 930 | 0,66 | [1,71] | 6 | Ø 360 | 1 700 | 1/4"-1/2" | 66 | 32 | 2.169 |
| | MDF-MG-1 016 | 5/8 | 230 V-I | 1 220 | 2 200 | 1 770 | 1 385 | 1 040 | 0,74 | [1,77] | 7 | Ø 360 | 1 700 | 1/4"-1/2" | 76 | 32 | 2.343 |
| | MDF-MG-1 018 | 3/4 | 230 V-I | 1 525 | 2 630 | 2 140 | 1 710 | 1 310 | 0,88 | [1,85] | 8 | Ø 360 | 1 700 | 1/4"-1/2" | 76 | 32 | 2.465 |
| | MDF-MG-1 024 | 1 | 230 V-I | 1 940 | 3 485 | 2 815 | 2 195 | 1 650 | 1,01 | [2,04] | 12 | Ø 360 | 1 700 | 3/8"-5/8" | 78 | 32 | 2.702 |
| | MDF-MG-1 026 | 1 1/4 | 230 V-I * | 2 185 | 3 790 | 3 085 | 2 455 | 1 870 | 1,13 | [2,05] | 13 | Ø 360 | 1 700 | 3/8"-5/8" | 78 | 32 | 2.762 |
| | MDF-MG-1 034 | 1 1/2 | 230 V-I * | 2 820 | 4 765 | 3 895 | 3 125 | 2 420 | 1,60 | [1,91] | 16 | Ø 360 | 1 700 | 3/8"-5/8" | 78 | 32 | 2.855 |
| | MDF-MG-1 038 | 1 3/4 | 400 V-III | 3 105 | 5 315 | 4 320 | 3 440 | 2 650 | 1,53 | [2,11] | 7 | Ø 450 | 3 200 | 3/8"-5/8" | 81 | 29 | 3.476 |
| MDF-MG-2 048 | 2 | 400 V-III | 3 985 | 6 805 | 5 525 | 4 410 | 3 410 | 1,89 | [2,25] | 8 | Ø 450 | 3 600 | 3/8"-3/4" | 85 | 26 | 3.903 | |
| MDF-MG-2 054 | 2 1/2 | 400 V-III | 4 595 | 7 660 | 6 250 | 5 020 | 3 950 | 2,09 | [2,35] | 9 | Ø 450 | 3 600 | 3/8"-3/4" | 86 | 26 | 4.132 | |
| MDF-MG-2 060 | 3 | 400 V-III | 5 300 | 8 655 | 7 105 | 5 750 | 4 575 | 2,48 | [3,26] | 10 | Ø 450 | 3 600 | 3/8"-3/4" | 87 | 26 | 4.510 | |
| MDF-MG-2 068 | 3 1/2 | 400 V-III | 5 975 | 9 635 | 7 955 | 6 460 | 5 160 | 2,85 | [3,14] | 10 | Ø 450 | 3 600 | 1/2"-3/4" | 88 | 25 | 4.738 | |

230 V-I-50 Hz* / 400 V-III-50 Hz | R449A / R452A | Baja temperatura | Condensadoras Silenciosas | Compresor hermético | R449A

| REFRIGERANTE | SERIE / MODELO SERIES / MODEL SÉRIES / MODÈLE | COMPRESOR COMPRESSOR COMPRESSEUR | | POTENCIA FRIGORÍF. POWER PUISSANCE FRIGORIF. EN13215 (W) ⁽¹⁾ T° EVAP. -35 °C | POT. FRIGOR./POWER/PUISSANCE FRIGORIF. (W) ⁽²⁾ TEMP. EVAPORAC./EVAPORATION TEMP./TEMP. D'ÉVAPOR. | | | POTEN.ABSOR. NOMINAL NOMINAL POW. ABSOR. PUISS.ABSORC. NOMINALE (kW) | [C.O.P.] S.E.P.R. ⁽³⁾ | INTENS. MÁX. ABSORCIÓN MAX. ABSOR. POWER INTENS. MAX. ABSOR. (A) | VENTILADOR FAN VENTILATEUR Ø mm | CAUDAL FLOW RATE DÉBIT D'AIR (m³/h) | CONEXIÓN FRIGORÍFICA COOLING CONNECTION CONNECTION FRIGORIFIQUE LIQ - GAS | PESO WEIGHT POIDS (kg) | NIVEL PRES. SONORA PRESS.LEVEL NIVEAU PRESS. SONORE dB(A) ⁽⁶⁾ | PVP PRICE PVP (€) |
|--------------|---|--|-----------|--|--|--------|--------|--|-------------------------------------|---|--|--|---|---------------------------------|---|----------------------------|
| | | CV | TENSIÓN | | -25 °C | -30 °C | -35 °C | | | | | | | | | |
| R449A | BDF-MG-0 018 | 5/8 | 230 V-I | 335 | 795 | 600 | 415 | 0,43 | [0,96] | 6 | Ø 200 | 350 | 1/4"-1/2" | 58 | 28 | 2.512 |
| | BDF-MG-1 026 | 3/4 | 230 V-I | 545 | 1 285 | 945 | 665 | 0,67 | [0,97] | 9 | Ø 360 | 1 700 | 1/4"-1/2" | 76 | 31 | 3.045 |
| | BDF-MG-1 034 | 1 1/4 | 230 V-I | 720 | 1 690 | 1 245 | 865 | 0,90 | [0,95] | 10 | Ø 360 | 1 700 | 3/8"-5/8" | 79 | 32 | 3.458 |
| | BDF-MG-1 055 | 1 3/4 | 230 V-I* | 920 | 2 425 | 1 745 | 1 160 | 1,17 | [0,99] | 16 | Ø 360 | 1 700 | 3/8"-5/8" | 85 | 34 | 3.905 |
| | BDF-MG-1 075 | 2 1/2 | 230 V-I* | 1 360 | 3 125 | 2 375 | 1 645 | 1,56 | [1,06] | 24 | Ø 360 | 1 700 | 3/8"-5/8" | 90 | 36 | 3.980 |
| | BDF-MG-2 096 | 3 1/2 | 400 V-III | 1 570 | 4 055 | 2 930 | 1 945 | 1,64 | [1,21] | 11 | Ø 450 | 3 600 | 3/8"-3/4" | 98 | 39 | 5.373 |
| | BDF-MG-2 108 | 4 | 400 V-III | 2 015 | 4 700 | 3 475 | 2 390 | 1,95 | [1,65] | 13 | Ø 450 | 3 600 | 3/8"-7/8" | 98 | 37 | 5.749 |
| | BDF-MG-2 136 | 5 | 400 V-III | 2 665 | 5 855 | 4 425 | 3 125 | 2,59 | [1,60] | 15 | Ø 450 | 3 600 | 3/8"-7/8" | 98 | 32 | 6.124 |
| | BDF-MG-3 215 | 7 1/2 | 400 V-III | 4 040 | 9 125 | 6 865 | 4 785 | 3,83 | [1,65] | 24 | 2x Ø 450 | 6 500 | 1/2"-1 1/8" | 149 | 39 | 7.740 |
| | BDF-MG-3 271 | 10 | 400 V-III | 5 840 | 11 755 | 9 020 | 6 600 | 5,13 | [1,68] | 28 | 2x Ø 450 | 6 500 | 1/2"-1 1/8" | 149 | 39 | 8.076 |

Serie / Series / Série **SIGILUS**

+Info: www.infrico.com

Versión multiservicio con sistema VRC
 Multiservice version VRC system
 Version multiservice avec système VRC



| COMPRESOR HERMÉTICO R134 a | | | |
|----------------------------|-------------------|---|-----------------------------|
| R134a | Versión Axial VRC | Potencia Frigorífica (W) T° EVAP. -10 °C | Precio Price (€) Prix |
| | Serie / Modelo | | |
| | MDF-VY-2 086 | 4.150 | 5.608 |
| | MDF-VY-2 108 | 5.040 | 5.870 |
| | MDF-VY-2 136 | 6.710 | 6.552 |
| | MDF-VY-3 171 | 7.440 | 7.606 |
| | MDF-VY-3 215 | 9.390 | 8.327 |
| MDF-VY-3 271 | 12.720 | 9.106 | |
| MEDIA TEMPERATURA R449A | | | |
| R449A | MDF-VG-1 038 | 3.540 | 4.701 |
| | MDF-VG-2 048 | 4.520 | 5.128 |
| | MDF-VG-2 054 | 5.140 | 5.357 |
| | MDF-VG-2 060 | 5.880 | 5.735 |
| | MDF-VG-2 068 | 6.600 | 5.963 |
| | MDF-VG-3 086 | 6.950 | 6.918 |
| | MDF-VG-3 108 | 9.200 | 7.557 |
| | MDF-VG-4 136 | 11.750 | 8.254 |
| MDF-VG-4 160 | 13.390 | 8.748 | |

Opciones / Options / Options

| | Precio Price (€) Prix |
|--|-----------------------------|
| Cambio a alimentación 400 V-III-50 Hz | + 8 % |
| Separador de aceite (ya incluido en versiones -V) | De serie |
| Válvula solenoide integrada con cuerpo y bobina (sólo en versiones -N y -M) | 178 € |
| Recubrimiento anticorrosión de batería | + 8 % |
| Rejilla exterior de protección de batería | 112 € |
| Control de condensación proporcional por variación de velocidad del motoventilador | De serie |
| Versión electrónica | +5 % |

| Dimensiones Dimensions Dimensions [mm] | A | B | C |
|--|-------|-----|-------|
| SERIE 0 | 671 | 308 | 442 |
| SERIE 1 | 1 030 | 380 | 580 |
| SERIE 2 | 1 080 | 416 | 827 |
| SERIE 3 | 1 150 | 487 | 1 097 |
| SERIE 4 | 1 150 | 487 | 1 346 |

Serie 0

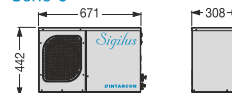

Serie 1

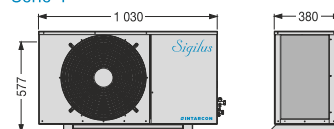

Serie 2

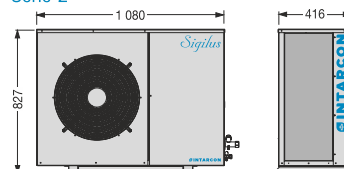

Serie 3

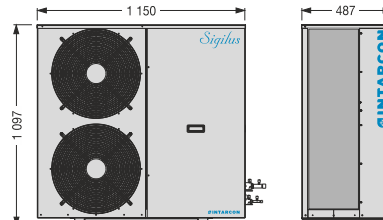

Motocondensadoras

Condensing units

Motocondensateurs

Opciones / Options / Options

| | Precio Price (€) Prix |
|---|-------------------------------------|
| Cambio a alimentación 400 V-III-50 Hz | 8 % |
| Separador de aceite [ya incluido en versiones -V] | 716 € |
| Resistencia de Cárter | 75 € |
| Válvula solenoide integrada con cuerpo y bobina [sólo en versiones -N y -M] | 178 € |
| Recubrimiento anticorrosión de batería | 8 % |
| Compuerta de descarga antirretorno | 67 € |
| Tolva de adaptación a conducto circular [series 3, 4] | 123 € |
| Control condensación proporcional por variación de velocidad | Axial + 304 € Centrífuga + 486 € |
| Versión electrónica | +5 % |



230 V-I-50 Hz / 400 V-III-50 Hz | R134a - R449A / R404A | Media temperatura

| REFRIGERANTE | VERSIÓN AXIAL | | COMPRESOR COMPRESSOR COMPRESSEUR | POTENCIA FRIGORÍF. POWER PUISSANCE FRIGORIF. EN13215 [W] T° EVAP. -10 °C | POT. FRIGOR./POWER/PUISSANCE FRIGORIF. [W] | | | | POTEN. ABSOR. NOMINAL POW. ABSOR. PUISS.ABSORC. NOMINALE [kW] | [C.O.P.] S.E.P.R. (3) | INTENS. MÁX. ABSORCIÓN POWER INTENS. MAX. ABSOR. | CONEXIÓN FRIGORÍFICA COOLING CONNECTION CONNECTION FRIGORIFIQUE | PESO WEIGHT POIDS | NIVEL PRES. SONORA SOUND PRESS.LEVEL NIVEAU PRESS. SONORE dB(A) | PVP PRICE PVP | VERSIÓN CENTRÍFUGA | | | |
|--------------|---|-----------|--|---|--|-------|-------|--------|--|--------------------------|--|--|-------------------------|---|---------------------|--------------------|---|------------------|--------------------|
| | SERIE / MODELO SERIES / MODEL SÉRIES / MODÈLE | CV | | | TENSIÓN | 0 °C | -5 °C | -10 °C | | | | | | | | -15 °C | SERIE / MODELO SERIES / MODEL SÉRIES / MODÈLE | CAUDAL [m³/h] | P.E.D. (3) [Pa] |
| R134a | MDH-MY-0 010 | 3/8 | 230 V-I | 575 | 890 | 715 | 565 | 430 | 0,37 | [1,54] | 4 | 1/4"-3/8" | 45 | 29 | 1.553 | MDH-CMY-0 010 | 375 | 8 | 1.779 |
| | MDH-MY-0 015 | 1/2 | 230 V-I | 800 | 1 215 | 985 | 785 | 600 | 0,51 | [1,58] | 5 | 1/4"-3/8" | 47 | 32 | 1.706 | MDH-CMY-0 015 | 375 | 8 | 2.007 |
| | MDH-MY-1 015 | 1/2 | 230 V-I | 840 | 1 305 | 1 050 | 825 | 630 | 0,50 | [1,69] | 5 | 1/4"-1/2" | 50 | 32 | 1.777 | MDH-CMY-1 015 | 575 | 8 | 2.141 |
| | MDH-MY-1 026 | 3/4 | 230 V-I | 1 225 | 1 910 | 1 530 | 1 200 | 900 | 0,72 | [1,72] | 9 | 1/4"-1/2" | 58 | 30 | 2.118 | MDH-CMY-1 026 | 575 | 8 | 2.288 |
| | MDH-MY-1 033 | 1 | 230 V-I | 1 555 | 2 325 | 1 890 | 1 505 | 1 155 | 0,83 | [1,87] | 9 | 1/4"-1/2" | 60 | 33 | 2.180 | MDH-CMY-1 033 | 575 | 8 | 2.695 |
| | MDH-MY-2 053 | 1 1/2 | 230 V-I * | 2 210 | 3 505 | 2 785 | 2 130 | 1 565 | 1,06 | [1,77] | 12 | 1/4"-5/8" | 70 | 38 | 2.776 | MDH-CMY-2 053 | 1 000 | 12 | 3.280 |
| | MDH-MY-3 074 | 2 | 230 V-I * | 3 045 | 4 855 | 3 845 | 2 940 | 2 140 | 1,36 | [2,08] | 16 | 1/4"-3/4" | 90 | 44 | 3.402 | MDH-CMY-3 074 | 1 500 | 14 | 3.747 |
| | MDH-MY-4 086 | 4 | 400 V-III | 4 160 | 6 660 | 5 270 | 4 065 | 3 040 | 2,02 | [2,23] | 14 | 3/8"-7/8" | 97 | 48 | 4.055 | MDH-CMY-4 086 | 3 500 | 10 | 5.138 |
| | MDH-MY-4 108 | 5 | 400 V-III | 5 065 | 7 940 | 6 380 | 4 935 | 3 690 | 2,46 | [2,09] | 17 | 3/8"-7/8" | 99 | 45 | 4.526 | MDH-CMY-4 108 | 3 500 | 10 | 5.607 |
| | MDH-MY-4 136 | 6 1/2 | 400 V-III | 6 410 | 9 595 | 7 825 | 6 215 | 4 720 | 3,33 | 2,85 | 20 | 3/8"-1 1/8" | 102 | 44 | 4.948 | MDH-CMY-4 136 | 3 500 | 10 | 6.033 |
| R449A | MDH-MG-0 008 | 1/3 | 230 V-I | 570 | 975 | 800 | 640 | 490 | 0,40 | [1,50] | 4 | 1/4"-3/8" | 46 | 31 | 1.435 | MDH-CMG-0 008 | 375 | 8 | 1.636 |
| | MDH-MG-0 010 | 3/8 | 230 V-I | 745 | 1 225 | 1 010 | 815 | 640 | 0,50 | [1,57] | 5 | 1/4"-3/8" | 46 | 34 | 1.480 | MDH-CMG-0 010 | 375 | 8 | 1.816 |
| | MDH-MG-0 012 | 1/2 | 230 V-I | 880 | 1 415 | 1 175 | 955 | 760 | 0,58 | [1,61] | 6 | 1/4"-3/8" | 46 | 34 | 1.550 | MDH-CMG-0 012 | 375 | 8 | 1.941 |
| | MDH-MG-1 014 | 1/2 | 230 V-I | 1 065 | 1 740 | 1 435 | 1 165 | 925 | 0,67 | [1,69] | 6 | 1/4"-1/2" | 50 | 34 | 1.686 | MDH-CMG-1 014 | 575 | 8 | 2.018 |
| | MDH-MG-1 016 | 5/8 | 230 V-I | 1 190 | 1 985 | 1 630 | 1 310 | 1 020 | 0,75 | [1,71] | 7 | 1/4"-1/2" | 60 | 34 | 1.874 | MDH-CMG-1 016 | 575 | 8 | 2.156 |
| | MDH-MG-1 018 | 3/4 | 230 V-I | 1 440 | 2 325 | 1 925 | 1 565 | 1 240 | 0,90 | [1,73] | 8 | 1/4"-1/2" | 60 | 34 | 1.970 | MDH-CMG-1 018 | 575 | 8 | 2.366 |
| | MDH-MG-2 024 | 1 | 230 V-I | 1 915 | 3 215 | 2 630 | 2 105 | 1 635 | 1,06 | [1,93] | 12 | 3/8"-5/8" | 60 | 35 | 2.162 | MDH-CMG-2 024 | 1 000 | 12 | 2.713 |
| | MDH-MG-2 026 | 1 1/4 | 230 V-I * | 2 130 | 3 485 | 2 870 | 2 320 | 1 830 | 1,19 | [1,91] | 13 | 3/8"-5/8" | 61 | 36 | 2.196 | MDH-CMG-2 026 | 1 000 | 12 | 2.922 |
| | MDH-MG-2 034 | 1 1/2 | 230 V-I * | 2 635 | 4 240 | 3 525 | 2 865 | 2 260 | 1,66 | [1,72] | 16 | 3/8"-5/8" | 61 | 37 | 2.260 | MDH-CMG-2 034 | 1 000 | 12 | 3.059 |
| | MDH-MG-3 038 | 1 3/4 | 400 V-III | 2 985 | 4 890 | 4 025 | 3 250 | 2 555 | 1,51 | [2,12] | 6 | 3/8"-5/8" | 78 | 39 | 2.855 | MDH-CMG-3 038 | 1 500 | 14 | 3.939 |
| MDH-MG-4 048 | 2 | 400 V-III | 3 955 | 6 685 | 5 430 | 4 345 | 3 390 | 2,07 | [2,06] | 13 | 3/8"-3/4" | 95 | 36 | 3.492 | MDH-CMG-4 048 | 3 500 | 10 | 4.573 | |
| MDH-MG-4 054 | 2 1/2 | 400 V-III | 4 535 | 7 515 | 6 145 | 4 940 | 3 900 | 2,30 | [2,13] | 14 | 3/8"-3/4" | 96 | 36 | 3.906 | MDH-CMG-4 054 | 3 500 | 10 | 4.990 | |
| MDH-MG-4 060 | 3 | 400 V-III | 5 220 | 8 435 | 6 980 | 5 655 | 4 505 | 2,74 | 2,97 | 15 | 3/8"-3/4" | 97 | 35 | 4.388 | MDH-CMG-4 060 | 3 500 | 10 | 5.546 | |
| MDH-MG-4 068 | 3 1/2 | 400 V-III | 5 880 | 9 330 | 7 775 | 6 345 | 5 075 | 3,16 | 2,86 | 15 | 1/2"-3/4" | 98 | 35 | 4.517 | MDH-CMG-4 068 | 3 500 | 10 | 6.171 | |

230 V-I-50 Hz* / 400 V-III-50 Hz | R449A - R452A | Baja temperatura | Compresor hermético

| REFRIGERANTE | VERSIÓN AXIAL | | COMPRESOR COMPRESSOR COMPRESSEUR | POTENCIA FRIGORÍF. POWER PUISSANCE FRIGORIF. EN13215 [W] T° EVAP. -35 °C | POT. FRIGOR./POWER/PUISSANCE FRIGORIF. [W] | | | POTEN. ABSOR. NOMINAL POW. ABSOR. PUISS.ABSORC. NOMINALE [kW] | [C.O.P.] S.E.P.R. (3) | INTENS. MÁX. ABSORCIÓN POWER INTENS. MAX. ABSOR. | CONEXIÓN FRIGORÍFICA COOLING CONNECTION CONNECTION FRIGORIFIQUE | PESO WEIGHT POIDS | NIVEL PRES. SONORA SOUND PRESS.LEVEL NIVEAU PRESS. SONORE dB(A) | PVP PRICE PVP | VERSIÓN CENTRÍFUGA | | | |
|--------------|---|-------|--|---|--|--------|--------|--|--------------------------|--|--|-------------------------|---|---------------------|--------------------|---|------------------|--------------------|
| | SERIE / MODELO SERIES / MODEL SÉRIES / MODÈLE | CV | | | TENSIÓN | -25 °C | -30 °C | | | | | | | | -35 °C | SERIE / MODELO SERIES / MODEL SÉRIES / MODÈLE | CAUDAL [m³/h] | P.E.D. (3) [Pa] |
| R449A | BDH-MG-1 026 | 3/4 | 230 V-I | 540 | 1 220 | 930 | 660 | 0,67 | [0,96] | 9,0 | 1/4"-1/2" | 51 | 31 | 2.295 | BDH-CMG-1 026 | 575 | 8 | 2.496 |
| | BDH-MG-1 034 | 1 1/4 | 230 V-I | 715 | 1 525 | 1 170 | 860 | 0,90 | [0,95] | 10,0 | 1/4"-1/2" | 52 | 33 | 2.369 | BDH-CMG-1 034 | 575 | 8 | 2.555 |
| | BDH-MG-2 055 | 1 3/4 | 230 V-I | 915 | 2 265 | 1 700 | 1 165 | 1,21 | [0,95] | 16,0 | 3/8"-5/8" | 61 | 41 | 3.022 | BDH-CMG-2 055 | 1 000 | 12 | 3.245 |
| | BDH-MG-2 075 | 2 1/2 | 230 V-I | 1 355 | 2 855 | 2 200 | 1 620 | 1,60 | [1,02] | 24,0 | 3/8"-5/8" | 66 | 44 | 3.096 | BDH-CMG-2 075 | 1 000 | 12 | 3.317 |
| | BDH-MG-3 096 | 3 1/2 | 400 V-III | 1 595 | 3 665 | 2 755 | 1 875 | 1,68 | [1,16] | 11 | 3/8"-3/4" | 88 | 49 | 4.477 | BDH-CMG-3 096 | 1 500 | 14 | 4.869 |
| | BDH-MG-4 108 | 4 | 400 V-III | 2 010 | 4 630 | 3 450 | 2 400 | 2,08 | 1,62 | 14,0 | 3/8"-7/8" | 108 | 47 | 5.710 | BDH-CMG-4 108 | 3 500 | 10 | 6.162 |
| | BDH-MG-5 136 | 5 | 400 V-III | 2 665 | 5 995 | 4 490 | 3 150 | 2,72 | 1,61 | 16,0 | 1/2"-1 1/8" | 152 | 42 | 7.661 | BDH-CMG-5 136 | 3 600 | 10 | 8.189 |
| | BDH-MG-5 215 | 7 1/2 | 400 V-III | 4 040 | 8 750 | 6 575 | 4 730 | 3,92 | 1,60 | 24,0 | 1/2"-1 1/8" | 183 | 49 | 8.164 | BDH-CMG-5 215 | 3 600 | 10 | 8.713 |

Serie / Series / Série **INTARBOX**

+Info: www.infrico.com

Versión multiservicio con sistema VRC
 Multiservice version VRC system
 Version multiservice avec système VRC



| MEDIA TEMPERATURA - COMPRESOR HERMÉTICO | | | |
|---|--|------------------|----------------|
| Versión Axial VRC | Potencia Frigorífica (W) T° EVAP. -10 °C | Precio Price (€) | |
| | | | Serie / Modelo |
| R134a | MDH-VY-4 086 | 4.020 | 5.280 |
| | MDH-VY-4 108 | 4.870 | 5.751 |
| | MDH-VY-4 136 | 6.500 | 6.173 |
| | MDH-VY-5 171 | 7.560 | 8.961 |
| | MDH-VY-5 215 | 9.310 | 9.101 |
| | MDH-VY-5 271 | 12.600 | 9.793 |
| | MEDIA TEMPERATURA R449A | | |
| R449A | MDH-VG-3 038 | 3.270 | 4.080 |
| | MDH-VG-4 048 | 4.420 | 4.717 |
| | MDH-VG-4 054 | 5.030 | 5.131 |
| | MDH-VG-4 060 | 5.740 | 5.613 |
| | MDH-VG-4 068 | 6.410 | 5.742 |
| | MDH-VG-5 086 | 7.270 | 7.168 |
| | MDH-VG-5 108 | 9.290 | 7.515 |

| MEDIA TEMPERATURA - COMPRESOR HERMÉTICO | | |
|---|-------------------------|----------------|
| Versión Centrífuga | Precio Price (€) | |
| | | Serie / Modelo |
| R134a | MDH-CVY-4086 | 6.363 |
| | MDH-CVY-4108 | 6.832 |
| | MDH-CVY-4136 | 7.258 |
| | MDH-CVY-5171 | 9.101 |
| | MDH-CVY-5215 | 9.584 |
| | MDH-CVY-5271 | 10.272 |
| | MEDIA TEMPERATURA R449A | |
| R449A | MDH-CVG-3038 | 5.164 |
| | MDH-CVG-4048 | 5.798 |
| | MDH-CVG-4054 | 6.215 |
| | MDH-CVG-4060 | 6.771 |
| | MDH-CVG-4068 | 7.396 |
| | MDH-CVG-5086 | 8.103 |
| | MDH-CVG-5108 | 8.616 |

Dimensiones DH-Axial / Dimensions DH-Axial

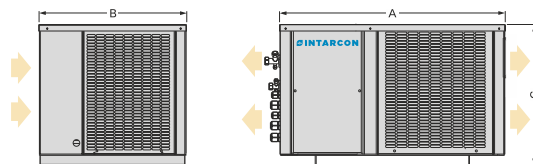

| Dimensiones (mm) | A | B | C |
|------------------|------|-----|-----|
| SERIE 0 | 600 | 396 | 355 |
| SERIE 1 | 665 | 435 | 416 |
| SERIE 2 | 835 | 435 | 500 |
| SERIE 3 | 925 | 580 | 515 |
| SERIE 4 | 1000 | 615 | 585 |
| SERIE 5 | 1289 | 757 | 657 |

Dimensiones DH-centrífuga / Dimensions dh-centrifugal

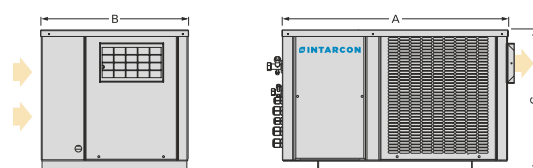

| Dimensiones (mm) | A | B | C | Embocadura turbina |
|------------------|------|-----|-----|--------------------|
| SERIE 0 | 600 | 396 | 355 | 185X115 |
| SERIE 1 | 665 | 435 | 416 | 185X115 |
| SERIE 2 | 835 | 435 | 500 | 230X130 |
| SERIE 3 | 925 | 580 | 515 | 236X266 |
| SERIE 4 | 1000 | 615 | 585 | 305X266 |
| SERIE 5 | 1289 | 757 | 657 | 305X266 |

| Opciones Options | Precio Price (€) Prix |
|---|---|
| Cambio a alimentación 400 V-III-50 Hz | 8 % |
| Separador de aceite [ya incluido en versiones -V] | De serie |
| Resistencia de Cártar | 75 € |
| Válvula solenoide integrada con cuerpo y bobina [sólo en versiones -N y -M] | 178 € |
| Recubrimiento anticorrosión de batería | 8 % |
| Compuerta de descarga antirretorno | 67 € |
| Tolva de adaptación a conducto circular [series 3, 4] | 123€ |
| Control condensación proporcional por variación de velocidad | Axial: De serie Centrífuga: De serie |
| Versión electrónica | + 5 % |



Sist. de refrig. para supermercados con condensación en circuito de agua con carga reducida

Supermarket refriger. syst. with indirect condensation by water circuit with reduced load

Syst. de réfrig. pour supermarchés à condensation avec circuit d'eau et charge réduite

Grupos condensados por agua

Descripción:

Grupos frigoríficos condensados por agua para refrigeración a temperatura positiva, de tamaño muy compacto y silencioso, diseñados para instalación en pared, suelo o sobre el servicio frigorífico.

Características:

Carrocería en chapa de acero galvanizado prelacado, con revestimiento fonoabsorbente, con registro frontal desmontable para acceso a compresor y cuadro eléctrico.

Inyección de líquido en modelos de baja temperatura con R 449 A

- Alimentación 400 V-III-50 Hz.
- Compresor scroll sobre soportes antivibratorios con aislamiento acústico.
- Condensador de placas soldadas de acero inoxidable.

Circuito frigorífico con recipiente, filtro, visor, válvula solenoide, presostatos de AP y BP y válvulas de servicio.

· Circuito hidráulico de condensación en tubo de cobre con conexiones roscadas.

· Cuadro eléctrico de control con protección diferencial y magnetotérmica.

Aeroenfriadores con grupo hidráulico

Descripción:

Aeroenfriadores de agua con grupo hidráulico, en construcción silenciosa, diseñados para la evacuación del calor del bucle de agua de condensación de equipos frigoríficos.

Características:

Motoventiladores axiales silenciosos de bajas revoluciones, montados en tobera, hélices equilibradas dinámicamente y rejillas de protección exterior.

· Batería de agua de alta eficiencia de tubos de cobre y aletas de aluminio.

· Grupo hidráulico incorporado formado por bomba circuladora electrónica con caudal variable, vaso de expansión, válvula de seguridad, filtro de malla, termomanómetros y toma de llenado/vaciado.

· Conexiones hidráulicas a roscar.

· Cuadro eléctrico de potencia, con protección de bomba hidráulica y motoventilador, y regulador de velocidad.

Water condensing units

Description:

Air-coolers with condensation by cooling water at positive temperature. very compact size and quiet, designed for wall, floor or above refrigeration services.

Characteristics:

Casing in prepainted galvanized steel sheet, with sound-absorbing insulation with removable front panel for access to the compressor and the electrical panel liquid injection in low temperature model with R-449 A.

- Power supply 400 V-III-50 Hz.
- Scroll compressor with sound insulation packet.
- Refrigeration circuit with stainless steel brazed plates heat exchanger.
- Ceramic drier filter, sight gauge for HP and LP solenoid valves.
- Hydraulic condensation circuit made of copper pipe with threaded connections.
- Electrical control panel with differential thermomagnetic protection.

Drycooler with built-in hydraulic group

Description:

Drycoolers with built-in hydraulic group, in a low-noise construction, designed for heat dissipation of the refrigeration equipment condensation water loop.

Characteristics:

Low speed axial fans, with dynamically balanced blades, supported by air nozzle and external protection grilles.

· High efficiency water coils with copper pipes and aluminum fins. Hydraulic group with variable flow electronic pump, expansion valve, safety valve, filter, thermomanometers and auto-fill valve included.

· Threaded hydraulic connections.

· Electric power panel, with protection of hydraulic pump and fan motor

Groupes condensés à eau

Description:

Groupes frigorifiques condensés à eau pour la réfrigération à température positive, de dimensions très compactes et silencieux, conçus pour installation murale, sol ou sur le mobilier frigorifique.

Caractéristiques:

Carrosserie en tôle d'acier galvanisée prélaquée, avec revêtement phonoabsorbant, avec registre frontal démontable pour l'accès au compresseur et tableau électrique.

Alimentation électrique 400V-III-50Hz.

Compresseur hermétique scroll sur des supports antivibratoires avec isolation acoustique.

Précharge de gaz R134a.

Condenseur à plaques brasées d'acier inoxydable. Circuit frigorifique avec bouteille de liquide, filtre, voyant de liquide, vanne solénoïde, pressostats HP et BP et vannes de service.

Circuit hydraulique de condensation en tube de cuivre avec des raccords filetés.

Tableau électrique de contrôle avec protection différentiel y magnétothermique.

Aérefroidisseurs avec groupe hydraulique

Description:

Les aérefroidisseurs d'eau avec groupe hydraulique, en construction silencieux, conçus pour l'évacuation de la chaleur de la boucle d'eau de condensation des équipements frigorifiques.

Caractéristiques:

Motoventilateurs axiaux silencieux de basse vitesse, montés en buse, hélices équilibrés dynamiquement et grilles de protection extérieure.

Batterie de refroidissement d'eau d'haute efficacité en tubes de cuivre et ailettes d'aluminium.

Groupe hydraulique incorporé composé d'une pompe électronique de circulation d'eau à débit variable, valve d'expansion, vanne de sécurité, filtre à tamis, thermomanomètre et prise de remplissage.

Connexions hydrauliques sur tableau électrique de puissance, avec protection de la pompe hydraulique et des motoventilateurs.

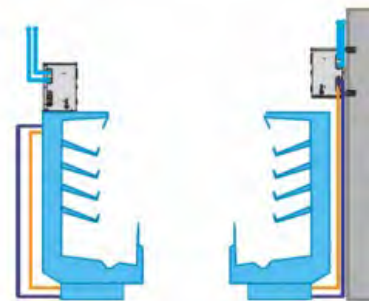
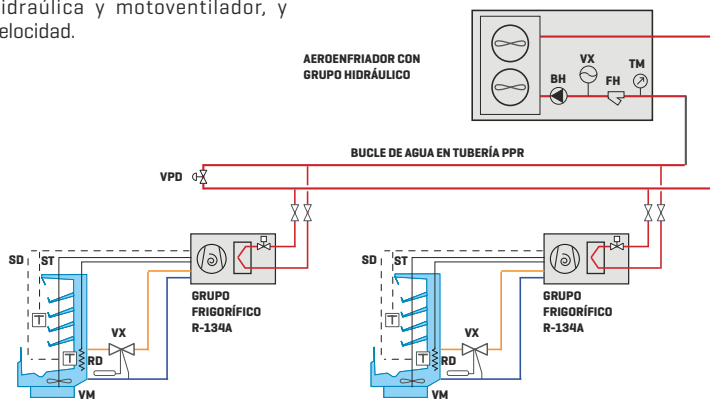

VPD: válvula de presión diferencial / differential pressure valve / Vanne de pression différentielle

ST: sonda termostato / thermostat probe / Sonde thermostatique

SD: sonda desescarche / defrost probe / Sonde de dégivrage

VX: válvula de expansión / expansion valve / Détendeur thermostatique

VM: motoventilador / motor fan / Motoventilateur

RD: resistencia de desescarche / defrost heater / Résistance de dégivrage

BH: bomba hidráulica / hydraulic pump / Pompe hydraulique

FH: filtro hidráulico de malla / hydraulic mesh filter / Filtre hydraulique à tamis

TM: termomanómetro / thermomanometer / Thermomanomètre

VX: vaso de expansión / buffer tank / Vanne d'expansion

Serie / Series / Série WATERLOOP

+Info: www.infrico.com

Grupos condensados por agua / Water condensing units / Unités de condensation à eau

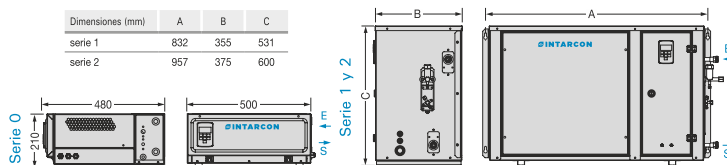

Opcional / Optional / Option

Carga de refrigerante para 5 metros de tubería
Refrigerant charge for 5 meters of pipe
Charge de réfrigérant pour 5 mètres de tube **+8%**

400 V-III-50 Hz | R134a - R449A | Media temperatura - Compresor scroll

| Refrigerante | Compresor | Serie / Modelo | | Potencia frigorífica [W] ⁽¹⁾ | | | Potencia absorb. nominal [kW] | Intens. máx. absorb. [A] | Caudal de agua [l/h] | Conexiones hidráulicas | Pérdida de carga [kPa] | Conexión frigorífica Liq-Gas | Peso Poids [kg] | S.PL N.P.A. dB[A] ^(e) | PVP [€] | |
|--------------|-----------|----------------|------------|---|----------------------------|--------|-------------------------------|--------------------------|----------------------|------------------------|------------------------|------------------------------|-----------------|----------------------------------|---------|-------|
| | | CV | Modelo | Tensión | Temperatura de evaporación | | | | | | | | | | | |
| | | 0 °C | -5 °C | -10 °C | | | | | | | | | | | | |
| R134a | 1x Scroll | MDM-SMY-1 009 | 1 1/4 ZS09 | 400 V-III * | 1 855 | 1 540 | 1 270 | 0,7 | 3 | 350 | 3/4" | 0,5 | 1/4"-5/8" | 34 | 40 | 3.166 |
| | | MDM-SMY-1 015 | 2 ZB15 | 400 V-III * | 2 840 | 2 360 | 1 945 | 1,1 | 5 | 500 | 3/4" | 0,5 | 1/4"-5/8" | 43 | 37 | 3.990 |
| | | MDM-SMY-1 021 | 3 ZB21 | 400 V-III * | 4 250 | 3 520 | 2 890 | 1,5 | 7 | 750 | 3/4" | 0,5 | 1/4"-3/4" | 53 | 40 | 4.443 |
| | | MDM-SMY-1 029 | 4 ZB29 | 400 V-III | 5 245 | 4 340 | 3 585 | 2,0 | 10 | 950 | 1" | 0,5 | 3/8"-7/8" | 53 | 40 | 5.006 |
| | | MDM-SMY-1 038 | 5 ZB38 | 400 V-III | 7 095 | 5 890 | 4 835 | 2,5 | 13 | 1 250 | 1" | 0,5 | 3/8"-7/8" | 68 | 53 | 5.483 |
| | | MDM-SMY-1 045 | 6 ZB45 | 400 V-III | 8 320 | 6 915 | 5 695 | 2,9 | 13 | 1 500 | 1" | 0,5 | 3/8"-1 1/8" | 70 | 43 | 5.781 |
| | | MDM-SMY-1 057 | 8 ZB57 | 400 V-III | 10 575 | 8 780 | 7 230 | 4,0 | 16 | 1 950 | 1 1/4" | 0,5 | 1/2"-1 1/8" | 75 | 50 | 6.678 |
| R449A | 1x Scroll | MDM-SMG-1 009 | 1 1/4 ZS09 | 400 V-III * | 3 095 | 2 585 | 2 135 | 1,1 | 2 | 500 | 1" | 0,5 | 1/4"-5/8" | 34 | 40 | 3.412 |
| | | MDM-SMG-1 015 | 2 ZB15 | 400 V-III * | 4 860 | 4 050 | 3 340 | 1,7 | 5 | 800 | 1" | 0,5 | 3/8"-5/8" | 43 | 37 | 3.800 |
| | | MDM-SMG-1 021 | 3 ZB21 | 400 V-III * | 7 365 | 6 140 | 5 080 | 2,4 | 7 | 1 200 | 1" | 0,5 | 3/8"-7/8" | 53 | 40 | 4.233 |
| | | MDM-SMG-1 029 | 4 ZB29 | 400 V-III | 9 610 | 8 020 | 6 635 | 3,2 | 10 | 1 500 | 1 1/4" | 0,5 | 3/8"-7/8" | 53 | 40 | 4.766 |
| | | MDM-SMG-1 038 | 5 ZB38 | 400 V-III | 12 445 | 10 380 | 8 540 | 4,1 | 13 | 2 000 | 1 1/4" | 0,5 | 3/8"-7/8" | 68 | 53 | 5.221 |
| | | MDM-SMG-1 045 | 6 ZB45 | 400 V-III | 14 715 | 12 270 | 10 130 | 4,7 | 13 | 2 500 | 1 1/4" | 0,5 | 3/8"-1 1/8" | 70 | 43 | 5.710 |

400 V-III-50 Hz | R449A | Baja temperatura - Compresor scroll

| Refrigerante | Compresor | Serie / Modelo | | Potencia frigorífica [W] ⁽¹⁾ | | | | Potencia absorb. nominal [kW] | Intens. máx. absorb. [A] | Caudal de agua [l/h] | Conexiones hidráulicas | Pérdida de carga [MCA] | Conexión frigorífica Liq-Gas | Peso Poids [kg] | S.PL N.P.A. dB[A] ^(e) | PVP [€] | |
|--------------|-----------|----------------|------------|---|----------------------------|-------|-------|-------------------------------|--------------------------|----------------------|------------------------|------------------------|------------------------------|-----------------|----------------------------------|---------|-------|
| | | CV | Modelo | Tensión | Temperatura de evaporación | | | | | | | | | | | | |
| | | -20 °C | -25 °C | -30 °C | -35 °C | | | | | | | | | | | | |
| R449A | 1x Scroll | BDM-SMG-1 006 | 2 ZF06 | 400 V-III | 2 360 | 1 910 | 1 525 | 1 195 | 1,5 | 5 | 550 | 3/4" | 0,5 | 1/4"-5/8" | 45 | 39 | 4.961 |
| | | BDM-SMG-1 009 | 3 ZF09 | 400 V-III | 3 210 | 2 590 | 2 070 | 1 620 | 1,9 | 6 | 700 | 3/4" | 0,5 | 3/8"-3/4" | 54 | 44 | 5.679 |
| | | BDM-SMG-1 011 | 3 1/2 ZF11 | 400 V-III | 4 050 | 3 275 | 2 610 | 2 045 | 2,3 | 8 | 850 | 3/4" | 0,5 | 3/8"-3/4" | 55 | 45 | 5.914 |
| | | BDM-SMG-2 013 | 4 ZF13 | 400 V-III | 4 595 | 3 715 | 2 970 | 2 325 | 2,5 | 9 | 950 | 1" | 0,5 | 3/8"-7/8" | 55 | 47 | 6.122 |
| | | BDM-SMG-2 015 | 5 ZF15 | 400 V-III | 5 640 | 4 560 | 3 640 | 2 850 | 3,3 | 10 | 1 250 | 1" | 0,5 | 3/8"-7/8" | 73 | 47 | 6.710 |
| | | BDM-SMG-2 018 | 6 ZF18 | 400 V-III | 6 685 | 5 400 | 4 310 | 3 375 | 3,9 | 14 | 1 500 | 1" | 0,5 | 3/8"-1 1/8" | 78 | 47 | 7.406 |
| | | BDM-SMG-2 025 | 8 ZF25 | 400 V-III | 8 400 | 6 795 | 5 430 | 4 265 | 4,2 | 16 | 2 000 | 1 1/4" | 0,5 | 3/8"-1 1/8" | 78 | 47 | 8.838 |

Waterloop aeroenfriadores con grupo hidráulico / Drycooler with built-in hydraulic group / Refroidisseurs à air avec groupe hydraulique

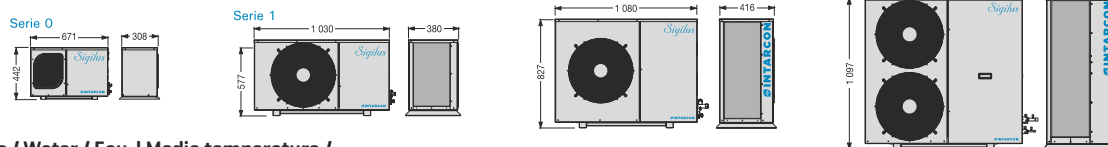

230-I-50 Hz | Agua / Water / Eau | Media temperatura /

| Series / Modelo | Tensión | Potencia térmica de intercambio [W] ⁽¹⁾ | Caudal de aire [m³/h] | Ventilador Ø mm | Caudal de agua [l/h] | Potencia absorb. nominal [kW] | Intens. máx. absorb. [A] | Presión disponible [kPa] | Conexiones hidráulicas | Peso [kg] | S.PL dB[A] ^(e) | PVP [€] |
|--------------------|---------|--|-----------------------|-----------------|----------------------|-------------------------------|--------------------------|--------------------------|------------------------|-----------|---------------------------|---------|
| Agua / Water / Eau | CWF-0 | 230 V-I | 3 000 | 1 700 | 1x Ø360 | 500 | 0,14 | 1,1 | 100 | 76 | 30 | 2.566 |
| CWF-1 | 230 V-I | 4 700 | 3 200 | 1x Ø450 | 750 | 0,22 | 1,8 | 100 | 79 | 26 | 3.811 | |
| CWF-2 | 230 V-I | 6 000 | 3 700 | 1x Ø450 | 1 000 | 0,24 | 2,0 | 100 | 81 | 26 | 4.914 | |
| CWF-3 | 230 V-I | 10 000 | 6 500 | 2x Ø450 | 1 500 | 0,44 | 3,6 | 100 | 101 | 29 | 6.104 | |
| CWF-4 | 230 V-I | 12 000 | 7 000 | 2x Ø450 | 2 000 | 0,48 | 3,9 | 100 | 113 | 29 | 6.541 | |
| CWF-6 | 230 V-I | 20 000 | 13 000 | 4x Ø450 | 3 000 | 0,88 | 7,0 | 100 | 160 | 32 | 10.263 | |
| CWF-8 | 230 V-I | 24 000 | 14 000 | 4x Ø450 | 4 000 | 0,96 | 7,5 | 100 | 185 | 32 | 11.355 | |

Los datos técnicos están sujetos a posibles variaciones que serán actualizadas periódicamente en las fichas técnicas del producto, disponibles en la web / The technical data are subject to possible variations that will be updated periodically in the technical data sheets of the product, which are available on the website / Les données techniques peuvent varier et seront actualisées dans les fiches techniques du produit, disponibles sur le site web.



Centrales frigoríficas Refrigeration units Centrales frigorífiques

INTARCUBE CENTRÍFUGA

Motocondensadoras y centrales de refrigeración compactas, de uno a tres compresores, con condensación centrífuga, para media y baja temperatura, incorporan cuadro eléctrico y regulación electrónica [según versión] con control de condensación.

Self-contained air-cooled refrigeration centrals, from 1 to 3 compressors, for positive and negative temperature applications, featuring control board and electronic regulation [depending on the version] with control of condensing temperature.

Motocondensateurs et installations frigorifiques compactes, de un à trois compresseurs, avec condensation centrifuge, pour moyenne et basse température, avec panneau électrique et régulation électronique [selon la version], avec contrôle de la condensation.

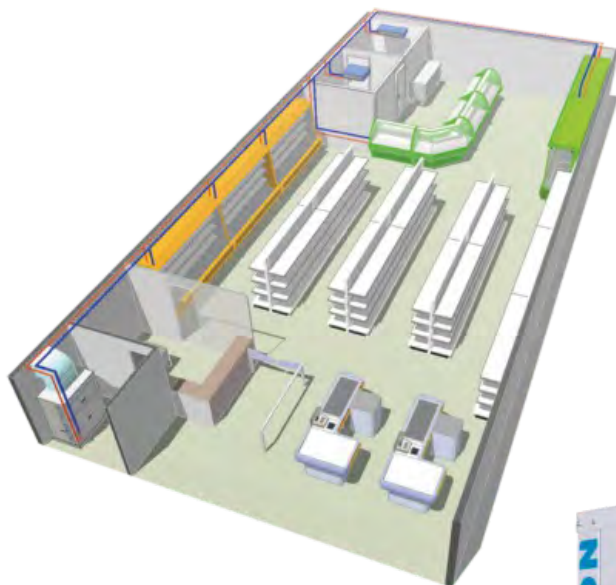

Serie / Series / Série **INTARCUBE**+Info: www.infrico.com**INTARCUBE AXIAL**

La central de refrigeración axial intarCUBE ha sido diseñada para su instalación en interperie capaz de funcionar bajo condiciones ambientales extremas, pudiendo dar servicio a varias unidades evaporadoras. Incorpora turbinas axiales y componentes aislados para proporcionar los más bajos niveles de ruido.

Axial air-condensed chillers are designed for outdoors installations, able to operate under extreme ambient conditions, to service several evaporating units and other applications at positive and/or several evaporating units and other applications at positive and/or negative temperature, like multiservice installations, or refrigeration installations with up to 4 power steps. Thanks to axial fans and insulating components, these units are able to provide the lowest sound levels.

Le groupe de refroidissement axial intarCUBE a été conçu pour leur installation extérieure, capable de fonctionner sous conditions environnementales extrêmes, il peut servir plusieurs unités d'évaporation. Il intègre des turbines axiales et des composants isolés pour garantir les niveaux de bruit les plus faibles.

Unidades motocondensadoras silenciosas / Low noise condensing units / Unités motocondensateurs silencieuses

Cuadro eléctrico integrado con protección diferencial (según modelo) y magnetotérmica
Integrated electrical panel with differential protection (depending on model and circuit breaker)
Tableau électrique intégré avec protection différentielle (selon le modèle), et magnétothermique

Manómetros de AP y BP (serie 6, 7 y 8)
AP and BP pressure gauge (series 6, 7 and 8)
Monomètre de AP et BP (série 6, 7 et 8)

Conexiones frigoríficas en el lateral izquierdo
Refrigerator connections on the left side
Connexions frigorifiques sur le côté gauche



Ventiladores axiales
Axial fans
Ventilateurs axiaux

Regulación electrónica de última generación [según versión]
Last generation electronic regulation (depending on version)
Contrôle électronique de dernière génération

Batería condensadora tropicalizada con separación del flujo del aire
Tropicalized condensing battery with airflow separation
Batterie condensatrice tropicalisée avec séparation de flux d'air

Compresores con aislamiento acústico
Compressors with sound insulation
Compresseurs avec isolement acoustique



Vitrinas Pastelería

Pastry display cases / Vitrines pâtisseries et glace



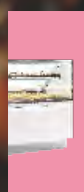

Serie / Series / Série

VGL
Glace

VGL C / CN
VGL P / PN
VGL M
VGL Ángulos/Angles/Angles 436-441

Serie / Series / Série

VNZ
Niza

VNZ / I / B
VNZ DT / IDT
VNZ HT / IHT
VNZ M / MHD
VNZ Ángulos/Angles/Angles 442-445

Serie / Series / Série

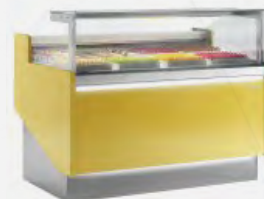
VLY
Lyon

VLY / I
VLY V
VLY B/IB
VLY BMS
VLY LG/ILG
VLY M/MHD
VLY Ángulos/Angles/Angles 446-453

Serie / Series / Série

VBR
Ámbar

VBR R / IR
VBR HT / IHT
VBR SS / ISS
VBR DS / IDS
VBR PHT / IPHT
VBR PC
VBR PSS / PDS 454-461

Serie / Series / Série

VON
Ónix

VON PR / PHT
VON R / HT
VON SS / DS 462-465

Serie / Series / Série

VCO
Combo

VCO 466-467

Serie / Series / Série

VMG
Magnus

VMG RU / B
VMG RU LG
VMG Ángulos/Angles/Angles
VMG P / Mueble caja
VMG C/M/MHD 468-477

Serie / Series / Série

VCB
Coral

VCB UH 478-479

Serie / Series / Série

VAR
Aries

VAR H 480-481

Serie / Series / Série

VBZ
Ibiza

VBZ U
VBZ SU 482-483



11. Vitrinas Pastelería

Pastry Display Cases / Vitrines Pâtisseries et Glace

Flexibilidad de implantación que te permiten combinar los diferentes tipos de venta dentro de un mismo lineal.

Flexibility of implementation that allows you to combine different types of sales on the same line.

Flexibilité de mise en œuvre qui permet de combiner différents types de ventes sur une même ligne.



Decoración con colores personalizables.

Decoration with customisable colours.

Décoration avec des couleurs personnalisables.

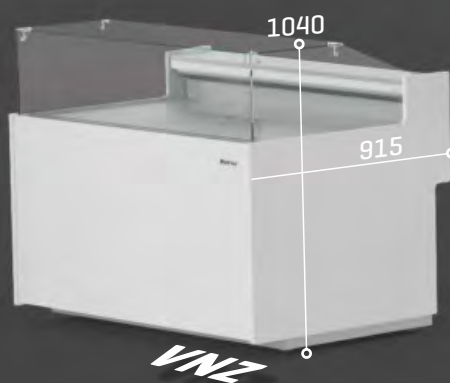
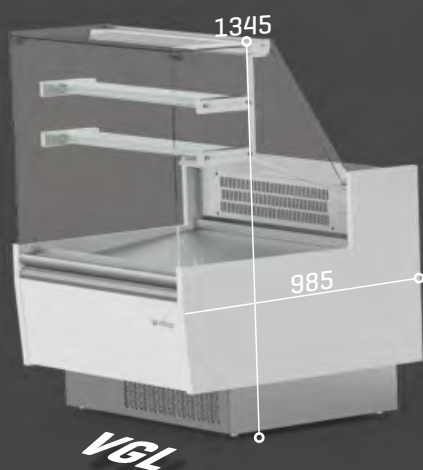

Testada en condiciones ambientales exigentes para ofrecer las mejores prestaciones en todas las condiciones ambientales.

Tested under demanding environmental conditions to provide the best performance in all environmental conditions.

Flexibilité de mise en œuvre qui permet de combiner différents types de ventes sur une même ligne.



Exposición de productos refrigerados, productos calientes y para temperatura ambiente.

Display of refrigerated products, hot products and products for ambient temperatures.

Exposition de produits réfrigérés, de produits chauds et de produits à température ambiante.

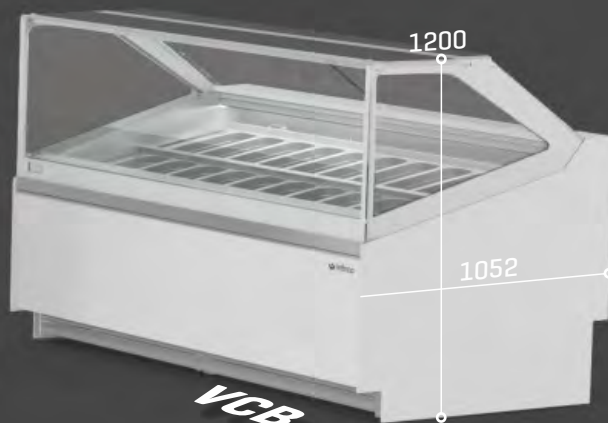
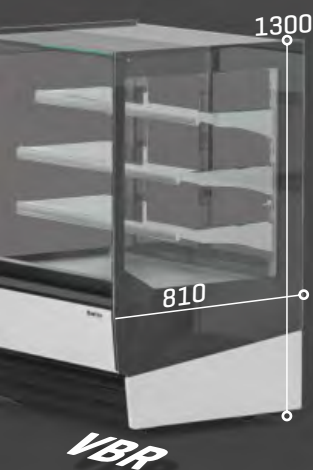





En la Ambar y VON: dos diseños diferentes, con cristal recto y curvo, para integrar dentro de todas las áreas de venta.

In the Ambar and VON: two different designs, with straight and curved glass, for integration into all sales areas.

Ambar et VON : deux modèles différents, avec verre droit et verre bombé, pour une intégration dans tous les espaces de vente.



Vitrina expositora con reserva para pastelería / Pastry display case with storage / Vitrine d'exposition pour pâtisserie avec réserve réfrigérée

| MODELO MODELE MODÈLE |  |  |  |  |  |
|---|---|---|--|---|---|
| Precio Price Prix | 2.513 € | 2.972 € | 3.354 € | 3.752 € | 4.456 € |
| | NEUTRO / NEUTRAL / NEUTRE | | | | |
| MOD. | VGL 9 CN | VGL 12 CN | VGL 15 CN | VGL 18 CN | VGL 25 CN |
| Precio Price Prix | 2.119 € | 2.580 € | 2.960 € | 3.118 € | 3.741 € |
| Medidas Measures Mesures (mm) | 998 x 985 x 1345 mm. | 1310 x 985 x 1345 mm. | 1622 x 985 x 1345 mm. | 1935 x 985 x 1345 mm. | 2560 x 985 x 1345 mm. |
| Temperatura Temperature Température (°C) | 4°C/+8°C | | | | |
| Clase Climática Climatic class Classe climatique (°C) | 3 / 25°C | | | | |
| Tensión/Frecuencia Electrical data Tension électrique | 230V/1ph/50Hz | | | | |
| Controlador Controller Régulateur | Digital | | | | |
| Material Material Matériel (EXT/INT) | Madera lacada / Lacquered wood / Bois laqué Plano exposición / Exhibition plan / Plan d'exposition: Inox Aisi 304 | | | | |
| Aislamiento Isolation Isolation (mm) | 40kg/m ³ / Free CFC's / Zero ODP-GWP | | | | |
| Capacidad Capacity Capacité (L) | 163 | 216 | 271 | 327 | 430 |
| Superficie exposición Surface exhibition Surface d'exposition (m ²) | 0,9 | 1,2 | 1,5 | 1,8 | 2,5 |
| Compresor Compressor Compresseur (HP) | - | | | | |
| Estantes Shelving Étagères | 2 | | | | |
| Costados [2] Sides [2] Joues [2] (mm) | 30+30 (INCLUIDOS / INCLUDES / INCLUS) | | | | |
| Sistema de frío Cooling System Système de froid | Ventilado / Ventilated / Ventilé | | | | |
| Desescarche Defrost Dégivrage | Manual / Manual / Manuel | | | | |
| Evaporación Evaporation Évaporation | Semiestática / Semistatic / Semiestatique | | | | |
| Potencia Power Puissance (W) | 292 | 451 | 451 | 613 | 653 |
| Potencia frig. Cooling capacity Puissance Frig. (W A -10°C) | 370 | 687 | 687 | 951 | 951 |
| Consumo Consumption Consommation (kWh/ 24h) | - | | | | |
| Refrigerante Refrigerant Gaz | R-290 | | | | |
| Opcional Optional Options | Puertas correderas traseras / Rear sliding doors / Portes coulissantes arrière VGL 9 [KPUVGL9C+] 120 € VGL 12 [KPUVGL12C+] 147 € VGL 15 [KPUVGL15C+] 178 € VGL 18 [KPUVGL18C+] 241 € VGL 25 [KPUVGL25C+] 299 € | | | | |

Serie / Series / Série **GLACE**

+Info: www.infrico.com

VGL25C



Laterales / Sides / Jous

Incluidos / Includes / Inclus

Ext. Estándar / Standar / Standard

| | | |
|--------------------|--------------------|----------------|
| Ral 9016 | Ral 1001 | Ral 1018 |
| Ral 2003 | Ral 3003 | Ral 3020 |
| Ral 4007 | Design 3504035 | Ral 5015 |
| Design 1107060 | Ral 6002 | Design 2108025 |
| Ral 8017 | Ral 9006 | Ral 7016 |
| Nogal-Walnut-Noyer | Wengué-Wenge-Wenge | Ral 9017 |

VGL15C

Colores fuera de carta / Colors outside of letter / Couleurs spéciales, hors palette



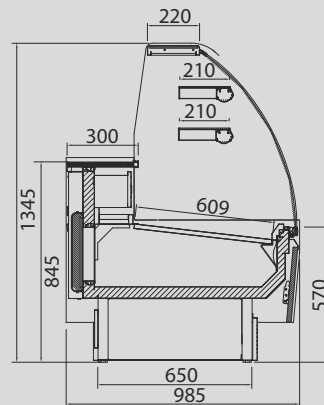

| RAL | | NO RAL | |
|--|--------------------------------|---|--------------------------------|
| Epoxi | Líquida/ Liquid/ Liquide | Epoxi | Líquida/ Liquid/ Liquide |
| 778 € | 484 € | Consultar / Consulter / Consulter | |
| [x unidad/x unit/x unité] | | | |
| +10 días laborables / +10 work days / +10 jours ouvrés | | Consultar / Consulter / Consulter | |



VGL C



Vitrina expositora con reserva para pastelería / Pastry display case with storage / Vitrine d'exposition pour pâtisserie avec réserve réfrigérée

| MODELO MODELE MODÈLE |  |  |  |  |  |
|---|---|---|---|---|---|
| Precio Price Prix | 2.542 € | 3.034 € | 3.428 € | 3.787 € | 4.557 € |
| | NEUTRO / NEUTRAL / NEUTRE | | | | |
| MOD. | VGL 9 PN | VGL 12 PN | VGL 15 PN | VGL 18 PN | VGL 25 PN |
| Precio Price Prix | 2.139 € | 2.630 € | 3.060 € | 3.152 € | 3.841 € |
| Medidas Measures Mesures (mm) | 998 x 985 x 1345 mm. | 1310 x 985 x 1345 mm. | 1622 x 985 x 1345 mm. | 1935 x 985 x 1345 mm. | 2560 x 985 x 1345 mm. |
| Temperatura Temperature Température (°C) | 4°C/+8°C | | | | |
| Clase Climática Climatic class Classe climatique (°C) | 3 / 25°C | | | | |
| Tensión/Frecuencia Electrical data Tension électrique | 230V/1ph/50Hz | | | | |
| Controlador Controller Régulateur | Digital | | | | |
| Material Material Matériel (EXT/INT) | Madera lacada / Lacquered wood / Bois laqué Plano exposición / Exhibition plan / Plan d'exposition: Inox Aisi 304 | | | | |
| Aislamiento Isolation Isolation (mm) | 40kg/m ³ / Free CFC's / Zero ODP-GWP | | | | |
| Capacidad Capacity Capacité (L) | 163 | 216 | 271 | 327 | 430 |
| Superficie exposición Surface exhibition Surface d'exposition (m ²) | 0,9 | 1,2 | 1,5 | 1,8 | 2,5 |
| Compresor Compressor Compresseur (HP) | - | | | | |
| Estantes Shelving Étagères | 2 | | | | |
| Costados [2] Sides [2] Joues [2] (mm) | 30+30 (INCLUIDOS / INCLUDES / INCLUS) | | | | |
| Sistema de frío Cooling System Système de froid | Ventilado / Ventilated / Ventilé | | | | |
| Desescarche Defrost Dégivrage | Manual / Manual / Manuel | | | | |
| Evaporación Evaporation Évaporation | Semiestática / Semistatic / Semiestatique | | | | |
| Potencia Power Puissance (W) | 292 | 451 | 451 | 613 | 653 |
| Potencia frig. Cooling capacity Puissance Frig. (W A -10°C) | 370 | 687 | 687 | 951 | 951 |
| Consumo Consumption Consommation (kWh/ 24h) | - | | | | |
| Refrigerante Refrigerant Gaz | R-290 | | | | |
| Opcional Optional Options | Puertas correderas traseras / Rear sliding doors / Portes coulissantes arrière VGL 9 [KPUVGL9P+] 120 € VGL 12 [KPUVGL12P+] 147 € VGL 15 [KPUVGL15P+] 178 € VGL 18 [KPUVGL18P+] 241 € VGL 25 [KPUVGL25P+] 299 € | | | | |

Serie / Series / Série **GLACE**

+Info: www.infrico.com



Laterales / Sides / Jous

Incluidos / Includes / Inclus

Ext. Estándar / Standar / Standard

| | | |
|--------------------|--------------------|----------------|
| Ral 9016 | Ral 1001 | Ral 1018 |
| Ral 2003 | Ral 3003 | Ral 3020 |
| Ral 4007 | Design 3504035 | Ral 5015 |
| Design 1107060 | Ral 6002 | Design 2108025 |
| Ral 8017 | Ral 9006 | Ral 7016 |
| Nogal-Walnut-Noyer | Wengué-Wenge-Wenge | Ral 9017 |

Colores fuera de carta / Colors outside of letter / Couleurs spéciales, hors palette

| RAL | | NO RAL | |
|--|--------------------------------|---|--------------------------------|
| Epoxi | Líquida/ Liquid/ Liquide | Epoxi | Líquida/ Liquid/ Liquide |
| 778 € | 484 € | Consultar / Consulter / Consulter | |
| [x unidad/x unit/x unité] | | | |
| +10 días laborables / +10 work days / +10 jours ouvrés | | Consultar / Consulter / Consulter | |

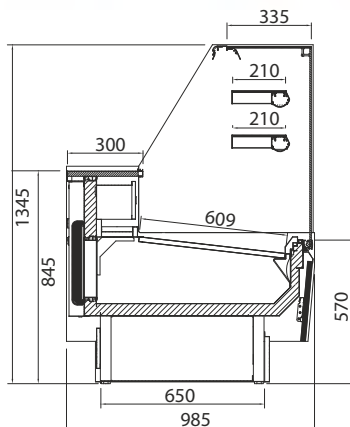

VGLP

Muebles caja / Counter case / Meuble caisse

Serie / Series / Série **GLACE**

| MODELO MODELE MODÈLE |  VGL 9 M |  VGL 15 M |  VGL 90 AAM |  VGL 90 ACM |
|--------------------------------|--|---|---|---|
| Precio Price Prix | 1.528 € | 1.855 € | 2.918 € | 2.827 € |
| Medidas Measures Mesures | 998 x 985 x 863 mm. | 1622 x 985 x 863 mm. | 1205 x 1140 x 863 mm. | 1045 x 766 x 863 mm. |



Laterales / Sides / Joues

Incluidos / Includes / Inclus

Ext. Estándar / Standar / Standard

| | | |
|------------------------|------------------------|----------------|
| Ral 9016 | Ral 1001 | Ral 1018 |
| Ral 2003 | Ral 3003 | Ral 3020 |
| Ral 4007 | Design 3504035 | Ral 5015 |
| Design 1107060 | Ral 6002 | Design 2108025 |
| Ral 8017 | Ral 9006 | Ral 7016 |
| Nogel-Walnut- Noyer | Wengué-Wenge- Wenge | Ral 9017 |

Colores fuera de carta /
Colors outside of letter /
Couleurs spéciales, hors palette

| RAL | | NO RAL | |
|--|--------------------------------|---|--------------------------------|
| Epoxi | Líquida/ Liquid/ Liquide | Epoxi | Líquida/ Liquid/ Liquide |
| 778 € | 484 € | Consultar / Consultar / Consultar | |
| [x unidad/x unit/x unité] | | | |
| +10 días laborables / +10 work days / +10 jours ouvrés | | Consultar / Consultar / Consultar | |



VGL15M

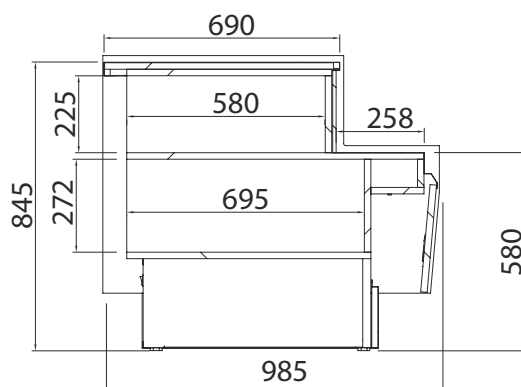





VGL M

+info: www.infrico.com



Vitrina expositora para pastelería / Pastry display case / Vitrine d'exposition pour pâtisserie

| MODELO MODELE MODÈLE | |  |  |  |  |  |
|---|-------------------|---|---|---|---|---|
| Precio Price Prix | VNZ | 2.565 € | 3.179 € | 3.547 € | 3.931 € | 3.354 € |
| | VNZ I | 2.642 € | 3.275 € | 3.689 € | 4.089 € | 3.509 € |
| | | DOBLE TEMPERATURA / DOUBLE TEMPERATURE / DOUBLE TEMPÉRATURE | | | | |
| MOD. | | VNZ 9 DT / IDT | VNZ 12 DT / IDT | VNZ 15 DT / IDT | VNZ 18 DT / IDT | - |
| Precio Price Prix | DT | 3.485 € | 3.944 € | 4.624 € | 5.214 € | - |
| | IDT | 3.570 € | 4.039 € | 4.766 € | 5.372 € | - |
| | | CALIENTE / HOT / CHAUD | | | | |
| MOD. | | VNZ 9 HT / IHT | VNZ 12 HT / IHT | VNZ 15 HT / IHT | VNZ 18 HT / IHT | - |
| Precio Price Prix | HT | 2.562 € | 2.940 € | 3.783 € | 4.180 € | - |
| | IHT | 2.780 € | 3.225 € | 3.977 € | 4.489 € | - |
| Medidas Measures Mesures | (mm) | 978 x 915 x 1040mm. | 1290 x 915 x 1040 mm. | 1602 x 915 x 1040 mm. | 1915 x 915 x 1040 mm. | 1290 x 915 x 1040 mm. |
| Temperatura Temperature Température | (°C) | VNZ: +4°C/+8°C DT: +4°C/+8°C HT: +40°C/+50°C | | | | |
| Clase Climática Climatic class Classe climatique | (°C) | 3 / 25°C | | | | |
| Tensión/Frecuencia Electrical data Tension électrique | | 230V/1ph/50Hz | | | | |
| Controlador Controller Régulateur | | Digital | | | | |
| Material Matériel | [EXT/INT] | Acero plastificado / Plastified galvanised steel / Acier galvanisé plastifié Plano exposición / Exhibition plan / Plan d'exposition: Inox Aisi 304 | | | | |
| Aislamiento Isolation Isolation | (mm) | 40kg/m ³ / Free CFC's / Zero ODP-GWP | | | | |
| Capacidad Capacity Capacité | (L) | 72 | 96 | 120 | 144 | 96 |
| Superficie exposición Surface exhibition Surface d'exposition | (m ²) | 0,60 | 0,80 | 1,00 | 1,20 | 0,80 |
| Compresor Compressor Compresseur | (HP) | 1/4 | | 1/3 | | 1/4 |
| Estantes Shelving Étagères | | - | | | | |
| Costados [2] Sides [2] Joues [2] | (mm) | 20+20 (INCLUIDOS / INCLUDES / INCLUS) | | | | |
| Sistema de frío Cooling System Système de froid | | Ventilado / Ventilated / Ventilé | | | | |
| Desescarche Defrost Dégivrage | | Automático / Automatic / Automatique | | | | |
| Evaporación Evaporation Évaporation | | Semiestática / Semistatic / Semiestatique | | | | |
| Potencia Power Puissance | (W) | VNZ / DT: 245 HT: 380 | VNZ / DT: 262 HT: 510 | VNZ / DT: 448 HT: 635 | VNZ / DT: 454 HT: 760 | 650 |
| Potencia frig. Cooling capacity Puissance Frig. | (W A -10°C) | - | | | | |
| Consumo Consumption Consommation | (kWh/ 24h) | VNZ 4,2 DT: 7,7,4 HT: 7,4 | VNZ 5,5 DT: 5,8/9,9 HT: 9,9 | VNZ 7,6 DT: 8,2/12,4 HT: 12,4 | VNZ 9,8 DT: 9,3/14,8 HT: 14,8 | 6,1 |
| Refrigerante Refrigerant Gaz | | R-290 | | | | |
| Opcional Optional Options | | - | | | | |

Serie / Series / Série **NIZA**

+Info: www.infrico.com

VNZ 12HT + VNZ 15HT



Laterales / Sides / Joues

Incluidos / Includes / Inclus

Ext. Estándar / Standar / Standard

| | | |
|----------------|----------------|----------------|
| Ral 9016 | Ral 1001 | Ral 1018 |
| Ral 2003 | Ral 3003 | Ral 3020 |
| Ral 4007 | Design 3504035 | Ral 5015 |
| Design 1107060 | Ral 6002 | Design 2108025 |
| Ral 8017 | Ral 9006 | Ral 7016 |
| Ral 9017 | | |

VNZ 12 + VNZ 15

Colores fuera de carta /
Colors outside of letter /
Couleurs spéciales, hors palette

| RAL | | NO RAL | |
|--|--------------------------------|---|--------------------------------|
| Epoxi | Líquida/ Liquid/ Liquide | Epoxi | Líquida/ Liquid/ Liquide |
| 817 € | 508 € | Consultar / Consultar / Consultar | |
| [x unidad/x unity/x unité] | | | |
| +10 días laborables / +10 work days / +10 jours ouvrés | | Consultar / Consultar / Consultar | |

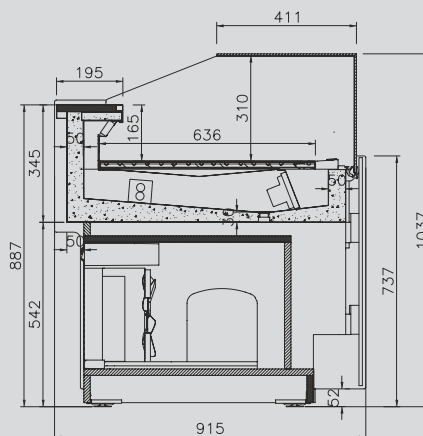







VNZ



Muebles caja / Counter case / Meuble caisse

Serie / Series / Série **NIZA**

| MODELO MODELE MODÈLE |  |  |  |  |  |  |  |
|---|---|---|---|---|---|---|---|
| Precio Price Prix | 1.838 € | 2.052 € | 2.199 € | 2.973 € | 1.649 € | 2.415 € | 1.680 € |
| Medidas/Measures/ Mesures [mm] Sin costados/Without sides/Sans joues | 998 x 915 x 740 mm. | 1290 x 915 x 740 mm. | 1290 x 915 x 740 mm. | 1855 x 915 x 740 mm. | 1035 x 915 x 740 mm. | 2325 x 915 x 740 mm. | 1295 x 915 x 740 mm. |

VNZ90AAM



Laterales / Sides / Joues

Incluidos / Includes / Inclus

Ext. Estándar / Standar / Standard

| | | |
|----------------|----------------|----------------|
| Ral 9016 | Ral 1001 | Ral 1018 |
| Ral 2003 | Ral 3003 | Ral 3020 |
| Ral 4007 | Design 3504035 | Ral 5015 |
| Design 1107060 | Ral 6002 | Design 2108025 |
| Ral 8017 | Ral 9006 | Ral 7016 |
| Ral 9017 | | |

Colores fuera de carta / Colors outside of letter / Couleurs spéciales, hors palette

| RAL | | NO RAL | |
|--|--------------------------------|---|--------------------------------|
| Epoxi | Líquida/ Liquid/ Liquide | Epoxi | Líquida/ Liquid/ Liquide |
| 817 € | 508 € | Consultar / Consulter / Consulter | |
| [x unidad/x unit/x unité] | | | |
| +10 días laborables / +10 work days / +10 jours ouvrés | | Consultar / Consulter / Consulter | |



VNZ12M





+Info: www.infrico.com



Los datos técnicos están sujetos a posibles variaciones que serán actualizadas periódicamente en las fichas técnicas del producto, disponibles en la web /
The technical data are subject to possible variations that will be updated periodically in the technical data sheets of the product, which are available on the website /
Les données techniques peuvent varier et seront actualisées dans les fiches techniques du produit, disponibles sur le site web.



Vitrina expositora para pastelería / Pastry display case / Vitrine d'exposition pour pâtisserie

| MODELO MODELE MODÈLE |  |  |  |  |  |
|--|---|---|---|---|---|
| Precio Price Prix | 2.850 € | 3.291 € | 3.850 € | 4.405 € | 5.219 € |
| | VLY 9I | VLY 12I | VLY 15I | VLY 18I | VLY 25I |
| Precio Price Prix | 2.937 € | 3.388 € | 3.995 € | 4.565 € | 5.395 € |
| Medidas/Measures/ Mesures/Without Sin costados/Without sides/Sans joues | 938 x 900 x 1305 mm. | 1250 x 900 x 1305 mm. | 1562 x 905 x 1305 mm. | 1875 x 905 x 1305 mm. | 2500 x 905 x 1305 mm. |
| Temperatura Temperature Température | 4°C/+8°C | | | | |
| Clase Climática Climatic class Classe climatique | 3 / 25°C | | | | |
| Tensión/Frecuencia Electrical data Tension électrique | 230V/1ph/50Hz | | | | |
| Controlador Controller Régulateur | Digital | | | | |
| Material Matériel | Ext: acero plastificado / Plastified stainless steel / Acier plastifié Encimera / Worktop / Dessous: Inox Aisi 304 Plano exposición / Exhibition plan / Plan d'exposition: Acero plastif.negro/ Plastif. Stainless steel black/ Acier plastifié noire (Mod. VLY) - Inox Aisi 304 (Mod. I) | | | | |
| Aislamiento Isolation | 40kg/m ³ / Free CFC's / Zero ODP-GWP | | | | |
| Capacidad Capacity Capacité | 72 | 96 | 120 | 144 | 192 |
| Superficie exposición Surface exhibition Surface d'exposition | 0,60 | 0,80 | 1,00 | 1,20 | 1,60 |
| Compresor Compressor Compresseur | 1/4 | | 1/3 | | 1/2 |
| Bandejas Trays Bacs | - | | | | |
| Costados [2] Sides [2] Joues [2] | 30+30 (NO INCLUIDOS / NOT INCLUDED / NON INCLUES) | | | | |
| Sistema de frío Cooling System Système de froid | Ventilado / Ventilated / Ventilé | | | | |
| Desescarche Defrost Dégivrage | Manual / Manual / Manuel | | | | |
| Evaporación Evaporation Évaporation | Semiestática / Semistatic / Semiestatique | | | | |
| Potencia Power Puissance | 245 | 262 | 448 | 454 | 588 |
| Potencia frig. Cooling capacity Puissance Frig. | - | | | | |
| Consumo Consumption Consommation | 4.2 | 5.5 | 7.6 | 9,8 | 10.3 |
| Refrigerante Refrigerant Gaz | R-290 | | | | |
| Opcional Optional Options | Puertas correderas traseras / Rear sliding doors / Portes coulissantes arrière | | | | |
| | (PUEVLY9CT) | (PUEVLY12CT) | (PUEVLY15CT) | (PUEVLY18CT) | (PUEVLY25CT) |
| | 75 € | 89 € | 109 € | 131 € | 162 € |
| | Estantes / Shelving / Étagères | | | | |
| (ESTVCB9) | (ESTVCB12) | (ESTVCB15) | (ESTVCB18) | (ESTVCB25) | |
| 208 € | 254 € | 275 € | 317 € | 448 € | |

Laterales no incluidos en el precio
Side panels not included in price
Joues non incluses dans le prix

Serie / Series / Série **LYON**

+Info: www.infrico.com

VLY15



Estante opcional
Optional shelf
Étagère en option

Laterales no incluidos en el precio
Side panels not included in price
Joues non incluses dans le prix

Laterales / Sides / Joues

| NO | |
|-----------------------------|----------------------------|
| Izquierdo Left Gauche | Derecho Right Droite |
| 250 € | 250 € |

Ext. Estándar / Standar / Standard

| | | |
|----------------|----------------|----------------|
| Ral 9016 | Ral 1001 | Ral 1018 |
| Ral 2003 | Ral 3003 | Ral 3020 |
| Ral 4007 | Design 3504035 | Ral 5015 |
| Design 1107060 | Ral 6002 | Design 2108025 |
| Ral 8017 | Ral 9006 | Ral 7016 |
| Ral 9017 | | |

Colores fuera de carta / Colors outside of letter / Couleurs spéciales, hors palette

| RAL | | NO RAL | |
|--|--------------------------------|---|--------------------------------|
| Epoxi | Líquida/ Liquid/ Liquide | Epoxi | Líquida/ Liquid/ Liquide |
| 817 € | 508 € | Consultar / Consulter / Consulter | |
| (x unidad/x unity/x unité) | | | |
| +10 días laborables / +10 work days / +10 jours ouvrés | | Consultar / Consulter / Consulter | |



VLY9

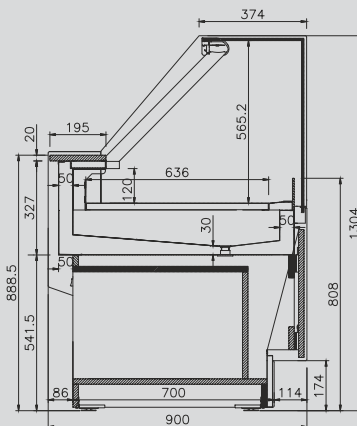

VLY

Vitrina expositora para pastelería / Pastry display case / Vitrine d'exposition pour pâtisserie

| MODELO MODELE MODÈLE | VIENNOISERIE (NEUTRA/NEUTRAL/NEUTRE) | | CHOCOLATE / CHOCOLAT | BAIN MARIE (CALIENTE/HOT/CHAUD) | |
|---|--|-----------------------------|--|---------------------------------|-----------------------------|
| | VLY 9 V | VLY 12 V | VLY 12 B / VLY 12 IB | VLY 12 BMS | VLY 15 BMS |
| Precio Price Prix | 3.584 € | 4.094 € | 3.393 / 3.550 € | 4.276 € | 4.894 € |
| Medidas/Measures/ Mesures [mm] Sin costados/Without sides/Sans joues | 938 x 900 x 1550 mm. | 1250 x 900 x 1550 mm. | 1250 x 900 x 1060 mm. | 1250 x 900 x 1305 mm. | 1562 x 900 x 1305 mm. |
| Temperatura Temperature [°C] Température | - | | +7°C/+12°C | +60°C/+70°C | |
| Clase Climática Climatic class Classe climatique [°C] | 3 / 25°C | | | | |
| Tensión/Frecuencia Electrical data Tension électrique | 230V/1ph/50Hz | | | | |
| Controlador Controller Régulateur | Digital | | | | |
| Material Matériel [EXT/INT] | Ext: acero plastificado / Plastified stainless steel / Acier plastifié Encimera / Worktop / Dessous: Inox Aisi 304 Plano exposición / Exhibition plan / Plan d'exposition: Acero plastif./ Plastif. Stainless steel/ Acier plastifié (Mod. V/B/BMS) - Inox Aisi 304 (Mod. I) | | | | |
| Aislamiento Isolation [mm] | 40kg/m ³ / Free CFC's / Zero ODP-GWP | | | | |
| Capacidad Capacity Capacité [L] | 184 | 245 | 96 | 78 | 163 |
| Superficie exposición Surface exhibition [m ²] Surface d'exposition | 1,13 | 1,50 | 0,80 | 0,69 | 0,86 |
| Compresor Compressor Compresseur [HP] | - | - | 1/5 | - | - |
| Bandejas Trays Bacs [300x400] [600x400] | - | - | - | 3 | 4 |
| Costados [2] Sides [2] Joues [2] [mm] | 30+30 | | | | |
| Sistema de frío Cooling System Système de froid | Ventilado / Ventilated / Ventilé | | | | |
| Desescarche Defrost Dégivrage | Manual / Manual / Manuel | | | | |
| Evaporación Evaporation Évaporation | Semiestática / Semistatic / Semiestatique | | | | |
| Potencia Power [W] Puissance | 45 | 70 | 795 | 2050 | 3050 |
| Potencia frig. Cooling capacity Puissance Frig. [W A -10°C] | - | - | 254 | - | - |
| Consumo Consumption [kWh/ 24h] | 0,6 | 1 | 6,1 | 12,3 | 18,3 |
| Refrigerante Refrigerant Gaz | R-290 | | | | |
| Opcional Optional Options | - | - | Puertas correderas traseras / Rear sliding doors / Portes coulissantes arrière [PUEVLY12CTB] 77 € | | - |

Laterales no incluidos en el precio
Side panels not included in price
Joues non incluses dans le prix

Serie / Series / Série **LYON VIENNOISERIE**
 Serie / Series / Série **LYON CHOCOLATE/CHOCOLAT**
 Serie / Series / Série **LYON BAIN MARIE**

+Info: www.infrico.com

Vitrina Baño María para servicio de comida caliente
 Display case Bain Marie for food service
 Vitrine Bain Marie pour plats chauds

VLY12BMS



VLY12B

Vitrina para venta de chocolates
 Display case for chocolate sale
 Vitrine pour la vente de chocolats



Puertas correderas traseras de serie
 Rear sliding doors standard
 Portes coulissantes arrières à série

Laterales / Sides / Jous

VLY V/BMS
Incluidos / Includes / Inclus

Laterales / Sides / Jous

| NO INCLUIDOS VLY B | |
|-----------------------------|----------------------------|
| Izquierdo Left Gauche | Derecho Right Droite |
| 234 € | 234 € |



Neutro
 Neutral
 Neutre

3 estantes de serie
 3 shelves standard
 3 étagères à série

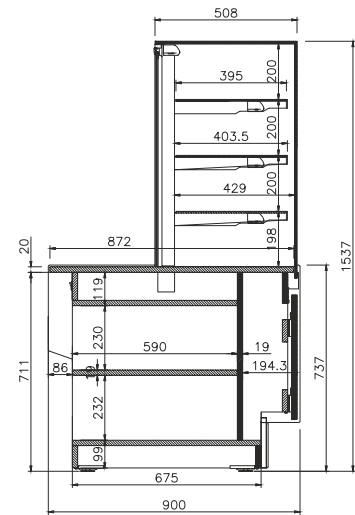

Ext. Estándar / Standar / Standard

| | | |
|----------------|----------------|----------------|
| Ral 9016 | Ral 1001 | Ral 1018 |
| Ral 2003 | Ral 3003 | Ral 3020 |
| Ral 4007 | Design 3504035 | Ral 5015 |
| Design 1107060 | Ral 6002 | Design 2108025 |
| Ral 8017 | Ral 9006 | Ral 7016 |
| Ral 9017 | | |

Colores fuera de carta /
 Colors outside of letter /
 Couleurs spéciales, hors palette

| RAL | | NO RAL | |
|--|--------------------------------|---|--------------------------------|
| Epoxi | Líquida/ Liquid/ Liquide | Epoxi | Líquida/ Liquid/ Liquide |
| 817 € | 508 € | Consultar / Consulter / Consulter | |
| (x unidad/x unity/x unité) | | Consultar / Consulter / Consulter | |
| +10 días laborables / +10 work days / +10 jours ouvrés | | Consultar / Consulter / Consulter | |

VLY9V

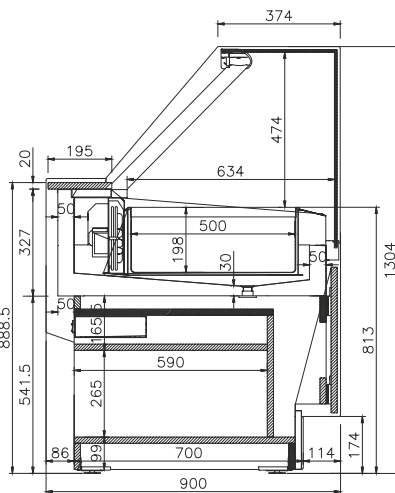



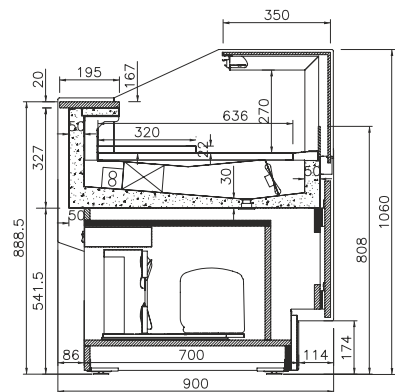

VLY BMS

VLY V



VLY B

Vitrina expositora para pastelería cristal bajo / Pastry display case low glass / Vitrine d'exposition pour pâtisserie vitre basse

| MODELO MODELE MODÈLE |  |  |  |  |  |
|---|--|---|---|--|--|
| Precio Price Prix | 2.835 € | 3.261 € | 3.798 € | 4.361 € | 5.138 € |
| | VLY 9 ILG | VLY 12 ILG | VLY 15 ILG | VLY 18 ILG | VLY 25 ILG |
| Precio Price Prix | 2.922 € | 3.359 € | 3.943 € | 4.521 € | 5.314 € |
| Medidas/Measures/ Mesures/Without Sin costados/Without sides/Sans joues (mm) | 938 x 900 x 1060 mm. | 1250 x 900 x 1060 mm. | 1562 x 900 x 1060 mm. | 1875 x 900 x 1060 mm. | 2500 x 900 x 1060 mm. |
| Temperatura Temperature Température (°C) | +4°C/+8°C | | | | |
| Clase Climática Climatic class Classe climatique (°C) | 3 / 25°C | | | | |
| Tensión/Frecuencia Electrical data Tension électrique | 230V/1ph/50Hz | | | | |
| Controlador Controller Régulateur | Digital | | | | |
| Material Matériel (EXT/INT) | Ext: acero plastificado / Plastified stainless steel / Acier plastifié Encimera / Worktop / Dessous: Inox Aisi 304 Plano exposición / Exhibition plan / Plan d'exposition: Acero plastif. negro/ Plastif. Stainless steel black / Acier plastifié noire (Mod. LG) - Inox Aisi 304 (Mod. I) | | | | |
| Aislamiento Isolation Isolation (mm) | 40kg/m ³ / Free CFC's / Zero ODP-GWP | | | | |
| Capacidad Capacity Capacité (L) | 72 | 96 | 120 | 144 | 192 |
| Superficie exposición Surface exhibition Surface d'exposition (m ²) | | | | | |
| Compresor Compressor Compresseur (HP) | 1/4 | | 1/3 | | 1/2 |
| Bandejas Trays Bacs (300x400) (600x400) | - | | | | |
| Costados [2] Sides [2] Joues [2] (mm) | 30+30 (NO INCLUIDOS / NOT INCLUDED / NON INCLUES) | | | | |
| Sistema de frío Cooling System Système de froid | Ventilado / Ventilated / Ventilé | | | | |
| Desescarche Defrost Dégivrage | Manual / Manual / Manuel | | | | |
| Evaporación Evaporation Évaporation | Semiestática / Semistatic / Semiestatique | | | | |
| Potencia Power Puissance (W) | 245 | 262 | 448 | 454 | 588 |
| Potencia frig. Cooling capacity Puissance Frig. (W A -10°C) | - | | | | |
| Consumo Consumption Consommation (kWh/ 24h) | 4.2 | 5.5 | 7.6 | 9,8 | 10.3 |
| Refrigerante Refrigerant Gaz | R-290 | | | | |
| Opcional Optional Options | Puertas correderas traseras / Rear sliding doors / Portes coulissantes arrière (PUEVLY9CTB) 61 € | Puertas correderas traseras / Rear sliding doors / Portes coulissantes arrière (PUEVLY12CTB) 77 € | Puertas correderas traseras / Rear sliding doors / Portes coulissantes arrière (PUEVLY15CTB) 91 € | Puertas correderas traseras / Rear sliding doors / Portes coulissantes arrière (PUEVLY18CTB) 107 € | Puertas correderas traseras / Rear sliding doors / Portes coulissantes arrière (PUEVLY25CTB) 137 € |

**Laterales no incluidos en el precio
Side panels not included in price
Joues non incluses dans le prix**

Serie / Series / Série **LYON LG**

+Info: www.infrico.com

VLY15LG



Laterales / Sides / Jous

NO INCLUIDOS

| | |
|-----------------------------|----------------------------|
| Izquierdo Left Gauche | Derecho Right Droite |
| 234 € | 234 € |

Ext. Estándar / Standar / Standard

| | | |
|----------------|----------------|----------------|
| Ral 9016 | Ral 1001 | Ral 1018 |
| Ral 2003 | Ral 3003 | Ral 3020 |
| Ral 4007 | Design 3504035 | Ral 5015 |
| Design 1107060 | Ral 6002 | Design 2108025 |
| Ral 8017 | Ral 9006 | Ral 7016 |
| Ral 9017 | | |



VLY12LG

Colores fuera de carta / Colors outside of letter / Couleurs spéciales, hors palette

| RAL | | NO RAL | |
|--|--------------------------------|---|--------------------------------|
| Epoxi | Líquida/ Liquid/ Liquide | Epoxi | Líquida/ Liquid/ Liquide |
| 817 € | 508 € | Consultar / Consulter / Consulter | |
| (x unidad/x unit/x unité) | | | |
| +10 días laborables / +10 work days / +10 jours ouvrés | | Consultar / Consulter / Consulter | |

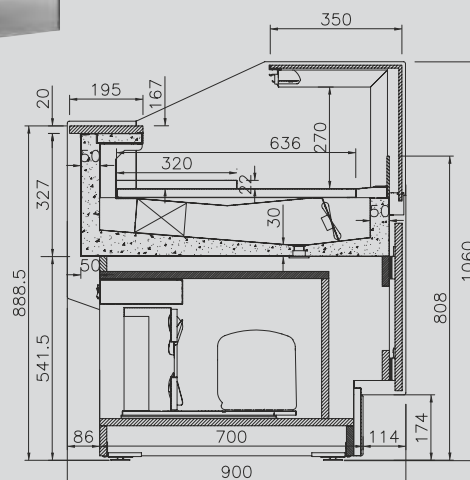







VLY LG



Muebles caja / Counter case / Meuble caisse

Serie / Series / Série **LYON**

| MODELO MODELE MODÈLE |  |  |  |  |  |  |  |
|---|---|---|---|---|---|---|---|
| Precio Price Prix | 1.885 € | 2.135 € | 2.351 € | 1.846 € | 2.265 € | 2.155 € | 2.997 € |
| Medidas/Measures/ Mesures [mm] Sin costados/Without sides/Sans joues | 938 x 900 x 745 mm. | 1250 x 900 x 745 mm. | 1250 x 900 x 745 mm. | 1035 x 900 x 745 mm. | 1855 x 900 x 745 mm. | 1295 x 900 x 745 mm. | 2325 x 900 x 745 mm. |

VLY12MHD

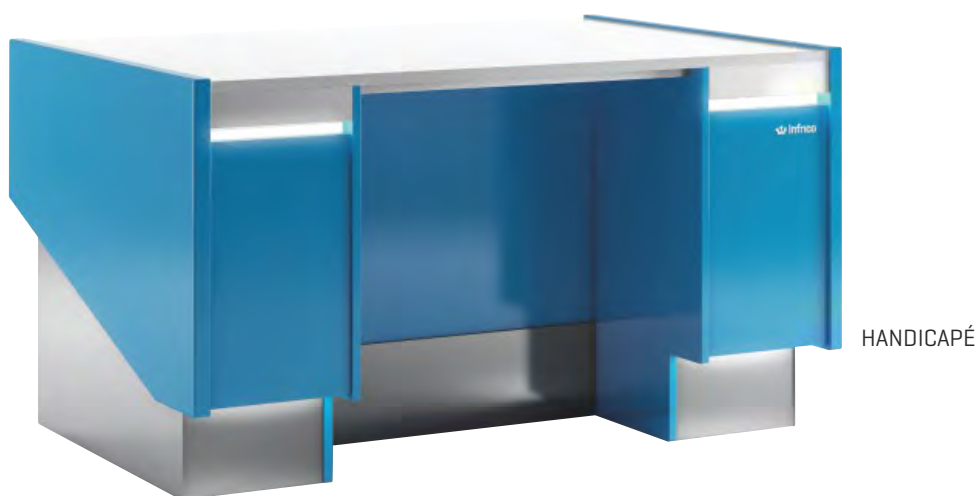

Laterales/ Sides / Joutes

Incluidos / Includes / Inclus

Ext. Estándar / Standar / Standard

| | | |
|----------------|----------------|----------------|
| Ral 9016 | Ral 1001 | Ral 1018 |
| Ral 2003 | Ral 3003 | Ral 3020 |
| Ral 4007 | Design 3504035 | Ral 5015 |
| Design 1107060 | Ral 6002 | Design 2108025 |
| Ral 8017 | Ral 9006 | Ral 7016 |
| Ral 9017 | | |

Colores fuera de carta / Colors outside of letter / Couleurs spéciales, hors palette

| RAL | | NO RAL | |
|--|--------------------------------|---|--------------------------------|
| Epoxi | Líquida/ Liquid/ Liquide | Epoxi | Líquida/ Liquid/ Liquide |
| 817 € | 508 € | Consultar / Consultar / Consultar | |
| [x unidad/x unit/x unité] | | | |
| +10 días laborables / +10 work days / +10 jours ouvrés | | Consultar / Consultar / Consultar | |



VLY9M

+Info: www.infrico.com

osmarc.es



Los datos técnicos están sujetos a posibles variaciones que serán actualizadas periódicamente en las fichas técnicas del producto, disponibles en la web /
The technical data are subject to possible variations that will be updated periodically in the technical data sheets of the product, which are available on the website /
Les données techniques peuvent varier et seront actualisées dans les fiches techniques du produit, disponibles sur le site web.

Serie Ámbar



VBR12PC







VBR12PDS

VBR12PSS

VBR12PR



Vitrina expositora para pastelería / Pastry display case / Vitrine d'exposition pour pâtisserie

| MODELO MODELE MODÈLE | |  |  |  |  |
|---|--|---|---|---|---|
| | | | REFRIGERADA / REFRIGERATED / RÉFRIGÉRÉ | | |
| | | | VBR 9 R/IR | VBR 12 R/IR | VBR 18 R/IR |
| Precio Price Prix | R | - | 4.133 € | 4.654 € | 5.901 € |
| | IR | - | 4.381 € | 4.928 € | 6.249 € |
| | | | CALIENTE / HOT / CHAUD | | |
| | MOD. | - | VBR 9 HT/IHT | VBR 12 HT/IHT | VBR 18 HT/IHT |
| Precio Price Prix | HT | - | 3.659 € | 4.154 € | 5.273 € |
| | IHT | - | 3.879 € | 4.398 € | 5.583 € |
| | | | AUTOSERVICIO / SELF SERVICE / LIBRE SERVICE | | |
| | MOD. | VBR 6 SS/ISS | VBR 9 SS/ISS | VBR 12 SS/ISS | VBR 18 SS/ISS |
| Precio Price Prix | SS | 3.138 € | 3.729 € | 4.076 € | 5.369 € |
| | ISS | 3.339 € | 3.967 € | 4.337 € | 5.711 € |
| | | | DOBLE SERVICIO / DOUBLE SERVICE / DOUBLE SERVICE | | |
| | MOD. | - | VBR 9 DS/IDS | VBR 12 DS/IDS | VBR 18 DS/IDS |
| Precio Price Prix | DS | - | 4.229 € | 4.767 € | 6.279 € |
| | IDS | - | 4.475 € | 5.053 € | 6.645 € |
| Medidas/Measures/ Mesures [mm] | Sin costados/Without sides/Sans joues | 625 x 810 x 1300 mm. | 938 x 810 x 1300 mm. | 1250 x 810 x 1300 mm. | 1875 x 810 x 1300 mm. |
| Temperatura Temperature Température [°C] | | R / SS / DS: +4°C/+8°C HT: +55°C/+60°C | | | |
| Clase Climática Climatic class Classe climatique [°C] | | 3 / 25°C | | | |
| Tensión/Frecuencia Electrical data Tension électrique | | 230V/1ph/50Hz | | | |
| Controlador Controller Régulateur | | Digital | | | |
| Material Material Matériel [EXT/INT] | | Ext: acero plastificado / Plastified steel / Acier plastifié Encimera / Worktop / Dessous: Inox Aisi 304 Plano exposición / Exhibition plan / Plan d'exposition: Acero plastif. negro/ Plastif. steel black/ Acier plastifié noire(R/HT/SS/DS) - Inox Aisi 304 (Mod. I) | | | |
| Aislamiento Isolation Isolation [mm] | | 40kg/m ³ / Free CFC's / Zero ODP-GWP | | | |
| Capacidad Capacity Capacité [L] | | 180 | 274 | 365 | 548 |
| Superficie exposición Surface exhibition Surface d'exposition [m ²] | | 0,9 | 1,4 | 1,9 | 2,8 |
| Compresor Compressor Compresseur [HP] | | 1/3 | 3/4 | 3/4 DS: 1 | 1 1/4 |
| Puertas / Estanterías Doors / Shelving Portes / Étagères | | R: - SS: - / 3 | HT: - DS: - | R: 2 / 3 SS: - / 3 | HT: 2 / 2 DS: 2 / 3 |
| Costados [2] Sides [2] Joues [2] [mm] | | 20+20 (INCLUIDOS / INCLUDES / INCLUS) | | | |
| Sistema de frío Cooling System Système de froid | | Ventilado / Ventilated / Ventilé | | | |
| Desescarche Defrost Dégivrage | | Automático / Automatic / Automatique | | | |
| Evaporación Evaporation Évaporation | | Semiestática / Semistatic / Semiestatique | | | |
| Potencia Power Puissance [W] | | R: - SS: 404 | HT: - DS: - | R: 708 SS: 708 | HT: 1080 DS: 708 |
| Potencia frig. Cooling capacity Puissance Frig. [W A -10°C] | | 750 | 1096 | 1315 | 2192 |
| Consumo Consumption Consommation [kWh/ 24h] | | R: - SS: 5.65 | HT: - DS: - | R: 8.5 SS: 9.25 | HT: 9.85 DS: 7.54 |
| Refrigerante Refrigerant Gaz | | R-290 | | | |
| Opcional Optional Options | | Cristal frontal doble / Double front glass / Double front glass VBR 9 284 € * VBR 12 289 € * VBR 18 567 € * | | | |

*Este precio es aplicable cuando el cristal va incorporado en el mueble.
This price is applicable when the glass is incorporated with the display case.
Prix applicable quand la vitre est livrée dans la vitrine

Serie / Series / Série **AMBAR**

+Info: www.infrico.com



VBR12HT



VBR12R



VBR6SS



VBR12DS



VBR SS/DS



VBR R/DS/HT

Laterales / Sides / Jous

Incluidos / Includes / Inclus

Ext. Estándar / Standar / Standard

| | | |
|--------------------|--------------------|----------------|
| Ral 9016 | Ral 1001 | Ral 1018 |
| Ral 2003 | Ral 3003 | Ral 3020 |
| Ral 4007 | Design 3504035 | Ral 5015 |
| Design 1107060 | Ral 8002 | Design 2108025 |
| Ral 8017 | Ral 9006 | Ral 7016 |
| Nogal-Walnut-Noyer | Wengué-Wenge-Wenge | Ral 9017 |

Colores fuera de carta / Colors outside of letter / Couleurs spéciales, hors palette

| RAL | | NO RAL | |
|---------------------------|--------------------------------|-------------|--------------------------------|
| Epoxi | Líquida/ Liquid/ Liquide | Epoxi | Líquida/ Liquid/ Liquide |
| 817 € | 508 € | Consultar / | Consultar / |
| [x unidad/x unit/x unité] | | Consultar / | Consultar / |
| +10 días laborables / | | Consultar / | Consultar / |
| +10 work days / | | Consultar / | Consultar / |
| +10 jours ouvrés | | Consultar / | Consultar / |

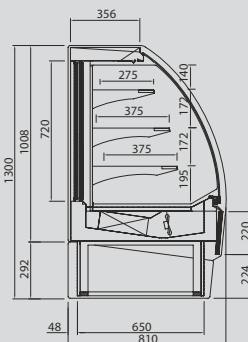

VBR R / DS

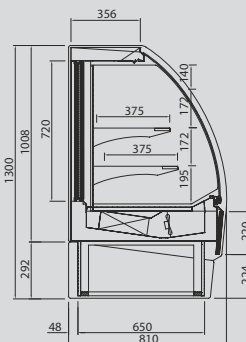



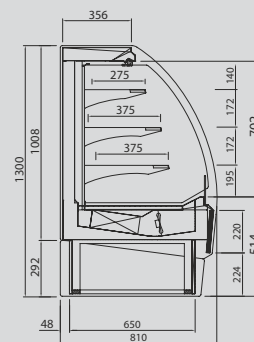

VBR HT



VBR SS



Vitrina expositora para pastelería / Pastry display case / Vitrine d'exposition pour pâtisserie

| MODELO MODELE MODÈLE | |  |  |  |  |  |
|---|-------------------|--|---|--|---|---|
| Precio Price Prix | PR | 4.450 € | 4.929 € | 6.210 € | | |
| | IPR | 4.717 € | 5.219 € | 6.575 € | | |
| | | CALIENTE / HOT / CHAUD | | | | |
| MOD. | | VBR 9 PHT/IPHT | VBR 12 PHT/IPHT | VBR 18 PHT/IPHT | VBR 9 PC | VBR 12 PC |
| Precio Price Prix | PHT IPHT | 3.649 € 3.868 € | 4.238 € 4.487 € | 5.378 € 5.589 € | 5.986 € | 6.474 € |
| Medidas/Measures/ Mesures (mm) Sin costados/Without sides/Sans joues | | 938 x 810 x 1300 mm. | 1250 x 810 x 1300 mm. | 1875 x 810 x 1300 mm. | 938 x 810 x 1300 mm. | 1250 x 810 x 1300 mm. |
| Temperatura Temperature Température | (°C) | PR: +4°C/+8°C PHT: +55°C/+60°C | | | +65°C | |
| Clase Climática Climatic class Classe climatique | (°C) | 3 / 25°C | | | | |
| Tensión/Frecuencia Electrical data Tension électrique | | 230V/1ph/50Hz | | | | |
| Controlador Controller Régulateur | | Digital | | | | |
| Material Matériel | [EXT/INT] | Ext: acero plastificado / Plastified steel / Acier plastifié Encimera / Worktop / Dessous: Inox Aisi 304 Plano exposición / Exhibition plan / Plan d'exposition: Acero plastif./ Plastif. steel/ Acier plastifié [PR/PHT] - Inox Aisi 304 [Mod. I] | | | | |
| Aislamiento Isolation Isolation | (mm) | 40kg/m ³ / Free CFC's / Zero ODP-GWP | | | | |
| Capacidad Capacity Capacité | (L) | 274 | 365 | 548 | 274 | 365 |
| Superficie exposición Surface exhibition Surface d'exposition | (m ²) | 1,4 | 1,9 | 2,8 | 1 | 1,4 |
| Compresor Compressor Compresseur | (HP) | 3/4 | 3/4 | 1 1/4 | | |
| Puertas / Estantes Doors / Shelving Portes / Étagères | | R: 2 / 3 HT: 2 / 2 | R: 2 / 3 HT: 2 / 2 | R: 2 / 3 HT: 2 / 2 | 2 / 2 | |
| Costados [2] Sides [2] Joues [2] | (mm) | 20+20 (INCLUIDOS / INCLUDES / INCLUS) | | | | |
| Sistema de frío Cooling System Système de froid | | Ventilado / Ventilated / Ventilé | | | | |
| Desescarche Defrost Dégivrage | | Manual / Manual / Manuel | | | | |
| Evaporación Evaporation Évaporation | | Semiestática / Semistatic / Semiestatique | | | | |
| Potencia Power Puissance | (W) | R: 708 HT: 1080 | R: 722 HT: 1107 | R: 1223 HT: 1125 | 3500 | 4670 |
| Potencia frig. Cooling capacity Puissance Frig. | (W A -10°C) | 1096 | 1315 | 2192 | | |
| Consumo Consumption Consommation | (kWh/ 24h) | R: 8.5 HT: 9.85 | R: 9.7 HT: 10,4 | R: 14.5 HT: 10.8 | 42 | 56 |
| Refrigerante Refrigerant Gaz | | R-290 | | | | |
| Opcional Optional Options | | - | | | | |

Serie / Series / Série **AMBAR**

+Info: www.infrico.com

VBR12PR



VBR12PHT



Posibilidad de intercalar módulo Self Service [consultar]
Possibility of adding a Self-Service module [contact us]
Possibilité d'intercaler le module Self Service [nous contacter]

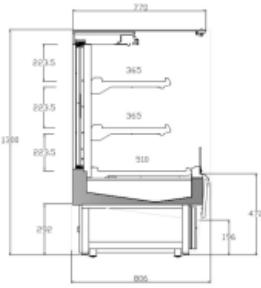

VBR PC

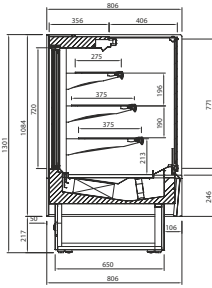

VBR PR

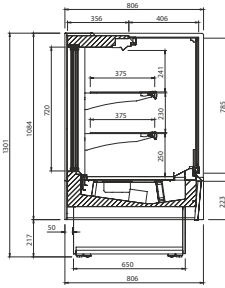

VBR PHT

VBR9PC



Laterales / Sides / Jous

Incluidos / Includes / Inclus

Ext. Estándar / Standar / Standard







| | | |
|--------------------|--------------------|----------------|
| Ral 9016 | Ral 1001 | Ral 1018 |
| Ral 2003 | Ral 3003 | Ral 3020 |
| Ral 4007 | Design 3504035 | Ral 5015 |
| Design 1107060 | Ral 6002 | Design 2108025 |
| Ral 8017 | Ral 9006 | Ral 7016 |
| Nogal-Walnut-Noyer | Wengué-Wenge-Wenge | Ral 9017 |

Colores fuera de carta / Colors outside of letter / Couleurs spéciales, hors palette

| RAL | | NO RAL | |
|--|------------------------|-----------------------------------|------------------------|
| Epoxi | Líquida/Liquid/Liquide | Epoxi | Líquida/Liquid/Liquide |
| 817 € | 508 € | Consultar / Consultar / Consultar | |
| [x unidad/x unit/x unité] | | | |
| +10 días laborables / +10 work days / +10 jours ouvrés | | Consultar / Consultar / Consultar | |



Vitrina expositora para pastelería / Pastry display case / Vitrine d'exposition pour pâtisserie

| | | VBR PSS / IPSS | | | | VBR PDS / IPDS | | |
|---|-------------------|--|---|---|---|---|---|---|
| MODELO MODELE MODÈLE | |  |  |  |  |  |  |  |
| Precio Price Prix | PR IPR | 3.166 € | 3.808 € | 4.208 € | 6.467 € | 4.287 € | 4.895 € | 6.467 € |
| | | INOX | | | | | | |
| MOD. | | VBR 6 IPSS | VBR 9 IPSS | VBR 12 IPSS | VBR 18 IPSS | VBR 9 IPDS | VBR 12 IPDS | VBR 18 IPDS |
| Precio Price Prix | PHT IPHT | 3.399 € | 4.052 € | 4.477 € | 5.930 € | 4.544 € | 5.156 € | 6.833 € |
| Medidas/Measures/ Mesures (mm) Sin costados/Without sides/Sans joues | | 625 x 810 x 1300 mm. | 938 x 810 x 1300 mm. | 1250 x 810 x 1300 mm. | 1875 x 810 x 1300 mm. | 938 x 810 x 1300 mm. | 1250 x 810 x 1300 mm. | 1875 x 810 x 1300 mm. |
| Temperatura Temperature Température | (°C) | -1°C/+7°C | | | | | | |
| Clase Climática Climatic class Classe climatique | (°C) | 3 / 25°C | | | | | | |
| Tensión/Frecuencia Electrical data Tension électrique | | 230V/1ph/50Hz | | | | | | |
| Controlador Controller Régulateur | | Digital | | | | | | |
| Material Matériel | [EXT/INT] | Ext: acero plastificado / Plastified steel / Acier plastifié Encimera / Worktop / Dessous: Inox Aisi 304 Plano exposición / Exhibition plan / Plan d'exposition: Acero plastif./ Plastif. steel/ Acier plastifié [PR/PHT] - Inox Aisi 304 [Mod. I] | | | | | | |
| Aislamiento Isolation Isolation | (mm) | 40kg/m ³ / Free CFC's / Zero ODP-GWP | | | | | | |
| Capacidad Capacity Capacité | (L) | 176 | 264 | 352 | 528 | 262 | 349 | 523 |
| Superficie exposición Surface exhibition Surface d'exposition | (m ²) | 1 | 1,4 | 1,9 | 2,8 | 1 | 1,4 | 2,8 |
| Compresor Compressor Compresseur | (HP) | 1/2 | 3/4 | 3/4 | 1/2 | 3/4 | 1 | 1/2 |
| Puertas / Estantes Doors / Shelving Portes / Étagères | | 0 / 3 | | | | 2 / 3 | | 3 / 3 |
| Costados [2] Sides [2] Joues [2] | (mm) | 20+20 (INCLUIDOS / INCLUDES / INCLUS) | | | | | | |
| Sistema de frío Cooling System Système de froid | | Ventilado / Ventilated / Ventilé | | | | | | |
| Desescarche Defrost Dégivrage | | Manual / Manual / Manuel | | | | | | |
| Evaporación Evaporation Évaporation | | Ventilado / Ventilated / Ventilé | | | | | | |
| Potencia Power Puissance | (W) | 523 | 709 | 724 | 1225 | 708 | 815 | 1223 |
| Potencia frig. Cooling capacity Puissance Frig. | (W A -10°C) | 850 | 1453 | 1453 | 2328 | 1453 | 1706 | 2328 |
| Consumo Consumption Consommation | (kWh/ 24h) | 6.84 | 9.28 | 9.47 | 14.7 | 7.54 | 9.95 | 14.91 |
| Refrigerante Refrigerant Gaz | | R-290 | | | | | | |
| Opcional Optional Options | | - | | | | | | |

Serie / Series / Série **AMBAR**

+Info: www.infrico.com

VBR12PSS



Laterales / Sides / Jous

Incluidos / Includes / Inclus

Ext. Estándar / Standar / Standard

| | | |
|--------------------|--------------------|----------------|
| Ral 9016 | Ral 1001 | Ral 1018 |
| Ral 2003 | Ral 3003 | Ral 3020 |
| Ral 4007 | Design 3504035 | Ral 5015 |
| Design 1107060 | Ral 6002 | Design 2108025 |
| Ral 8017 | Ral 9006 | Ral 7016 |
| Nogal-Walnut-Noyer | Wengué-Wenge-Wenge | Ral 9017 |



Colores fuera de carta /
Colors outside of letter /
Couleurs spéciales, hors palette

| RAL | | NO RAL | |
|--|--------------------------------|---|--------------------------------|
| Epoxi | Líquida/ Liquid/ Liquide | Epoxi | Líquida/ Liquid/ Liquide |
| 817 € | 508 € | Consultar / Consulter / Consulter | |
| [x unidad/x unit/x unité] | | | |
| +10 días laborables / +10 work days / +10 jours ouvrés | | Consultar / Consulter / Consulter | |

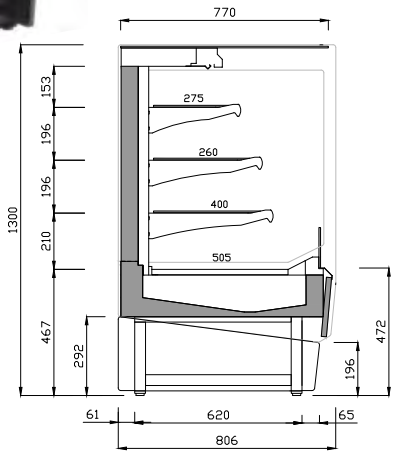
VBRPSS



Vitrina expositora para pastelería / Pastry display case / Vitrine d'exposition pour pâtisserie

| MODELO MODELE MODÈLE |  VON 9 PR |  VON 12 PR |  VON 18 PR |
|---|---|--|--|
| Precio Price Prix | 4.732 € | 5.242 € | 6.576 € |
| | CALIENTE / HOT / CHAUD | | |
| MOD. | VON 9 PHT | VON 12 PHT | VON 18 PHT |
| Precio Price Prix | 3.870 € | 4.377 € | 5.727 € |
| Medidas/Measures/ Mesures (mm) Sin costados/Without sides/Sans joues | 938 x 810 x 1300 mm. | 1250 x 810 x 1300 mm. | 1875 x 810 x 1300 mm. |
| Temperatura Temperature Température (°C) | PR: +4°C/+8°C PHT: +55°C/+60°C | | |
| Clase Climática Climatic class Classe climatique (°C) | 3 / 25°C | | |
| Tensión/Frecuencia Electrical data Tension électrique | 230V/1ph/50Hz | | |
| Controlador Controller Régulateur | Digital | | |
| Material Material Matériel [EXT/INT] | Aisi 304 | | |
| Aislamiento Isolation Isolation (mm) | 40kg/m ³ / Free CFC's / Zero ODP-GWP | | |
| Capacidad Capacity Capacité (L) | 274 | 365 | 548 |
| Superficie exposición Surface exhibition Surface d'exposition (m ²) | 1,4 | 1,9 | 2,8 |
| Compresor Compressor Compresseur (HP) | 1/2 | 3/4 | 1 1/4 |
| Puertas / Estantes Doors / Shelving Portes / Étagères | PR: 2 / 3 PHT: 2 / 2 | PR: 2 / 3 PHT: 2 / 3 | PR: 3 / 3 PHT: 3 / 2 |
| Costados (2) Sides (2) Joues (2) (mm) | 20+20 (INCLUIDOS / INCLUDES / INCLUS) | | |
| Sistema de frío Cooling System Système de froid | Ventilado / Ventilated / Ventilé | | |
| Desescarche Defrost Dégivrage | Manual / Manual / Manuel | | |
| Evaporación Evaporation Évaporation | Semiestática / Semistatic / Semiestatique | | |
| Potencia Power Puissance (W) | PR: 708 HT: 1080 | PR: 722 HT: 1107 | PR: 1223 HT: 1125 |
| Potencia frig. Cooling capacity Puissance Frig. (W A -10°C) | 1096 | 1315 | 1840 |
| Consumo Consumption Consommation (kWh/ 24h) | PR: 8.5 HT: 9.85 | PR: 9.7 HT: 10,4 | PR: 14.5 HT: 10.8 |
| Refrigerante Refrigerant Gaz | R-290 | | |
| Opcional Optional Options | - | | |

Serie / Series / Série **ONIX**

+Info: www.infrico.com

VON12PR



VON12PHT



Laterales / Sides / Joues

Incluidos / Includes / Inclus

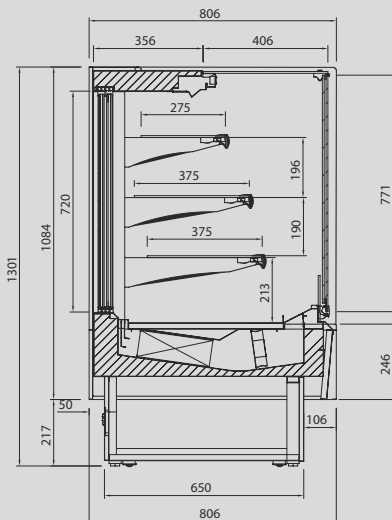



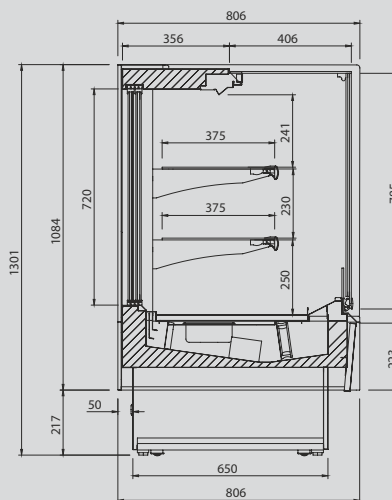

VON PR



VON PHT



Vitrina expositora para pastelería / Pastry display case / Vitrine d'exposition pour pâtisserie

| MODELO MODELE MODÈLE |  |  |  |  | | | | |
|---|--|---|---|---|-------------------------------------|--------------------------------------|-------------------------------------|--------------------------------------|
| Precio Price Prix | - | 4.313 € | 4.947 € | 6.365 € | | | | |
| CALIENTE / HOT / CHAUD | | | | | | | | |
| MOD. | - | VON 9 HT | VON 12 HT | VON 18 HT | | | | |
| Precio Price Prix | - | 3.767 € | 4.382 € | 5.587 € | | | | |
| AUTOSERVICIO / SELF SERVICE / LIBRE SERVICE | | | | | | | | |
| MOD. | VON 6 SS | VON 9 SS | VON 12 SS | VON 18 SS | | | | |
| Precio Price Prix | 3.306 € | 3.835 € | 4.312 € | 5.404 € | | | | |
| DOBLE SERVICIO / DOUBLE SERVICE / DOUBLE SERVICE | | | | | | | | |
| MOD. | - | VON 9 DS | VON 12 DS | VON 18 DS | | | | |
| Precio Price Prix | - | 4.367 € | 4.870 € | 6.535 € | | | | |
| Medidas/Measures/ Mesures [mm] Sin costados/Without sides/Sans joues | 1625 x 810 x 1300 mm. | 938 x 810 x 1300 mm. | 1250 x 810 x 1300 mm. | 1875 x 810 x 1300 mm. | | | | |
| Temperatura Temperature Température [°C] | R / SS / DS: +4°C/+8°C HT: +55°C/+65°C | | | | | | | |
| Clase Climática Climatic class Classe climatique [°C] | 3 / 25°C | | | | | | | |
| Tensión/Frecuencia Electrical data Tension électrique | 230V/1ph/50Hz | | | | | | | |
| Controlador Controller Régulateur | Digital | | | | | | | |
| Material Material Matériel [EXT/INT] | AISI 304 | | | | | | | |
| Aislamiento Isolation Isolation [mm] | 40kg/m ³ / Free CFC's / Zero ODP-GWP | | | | | | | |
| Capacidad Capacity Capacité [L] | 180 | 274 | 365 | 548 | | | | |
| Superficie exposición Surface exhibition Surface d'exposition [m ²] | 0,9 | 1,4 | 1,9 | 2,8 | | | | |
| Compresor Compressor Compresseur [HP] | 1/3 | 3/4 | 3/4 DS: 1 | 1 1/4 | | | | |
| Puertas / Estantes Doors / Shelving Portes / Étagères | R: - SS: - / 3 | HT: - DS: - | R: 2 / 3 SS: - / 3 | HT: 2 / 2 DS: 2 / 3 | R: 2 / 3 SS: - / 3 | HT: 2 / 2 DS: 2 / 3 | R: 2 / 3 SS: - / 3 | HT: 2 / 2 DS: 2 / 4 |
| Costados [2] Sides [2] Joues [2] [mm] | 20+20 (INCLUIDOS / INCLUDES / INCLUS) | | | | | | | |
| Sistema de frío Cooling System Système de froid | Ventilado / Ventilated / Ventilé | | | | | | | |
| Desescarche Defrost Dégivrage | Automático / Automatic / Automatique | | | | | | | |
| Evaporación Evaporation Évaporation | Semiestática / Semistatic / Semi-statique | | | | | | | |
| Potencia Power Puissance [W] | R: - SS: 404 | HT: - DS: - | R: 708 SS: 708 | HT: 1080 DS: 708 | R: 722 SS: 722 | HT: 1107 DS: 815 | R: 1223 SS: 1223 | HT: 1125 DS: 1223 |
| Potencia frig. Cooling capacity Puissance Frig. [W A -10°C] | 750 | | 1096 | | 1315 | | 2192 | |
| Consumo Consumption Consommation [kWh/ 24h] | R: - SS: 5.65 | HT: - DS: - | R: 8.5 SS: 9.25 | HT: 9.85 DS: 7.54 | R: 9.7 SS: 9.49 | HT: 10.4 DS: 9.95 | R: 14.5 SS: 15.8 | HT: 10.8 DS: 14.9 |
| Refrigerante Refrigerant Gaz | R-290 | | | | | | | |
| Opcional Optional Options | Cristal frontal doble / Double front glass / Double front glass VON 9 284 € * VON 12 289 € * VON 18 567 € * | | | | | | | |

***Este precio es aplicable cuando el cristal va incorporado en el mueble.**
This price is applicable when the glass is incorporated with the display case.
Prix applicable quand la vitre est livrée dans la vitrine

Serie / Series / Série **ONIX**

+Info: www.infrico.com

VON HT



VON SS



Laterales / Sides / Joues

Incluidos / Includes / Inclus

OPCIONAL Cristal frontal doble
OPTIONAL Double frontal glass
OPTION Double vitrage frontale

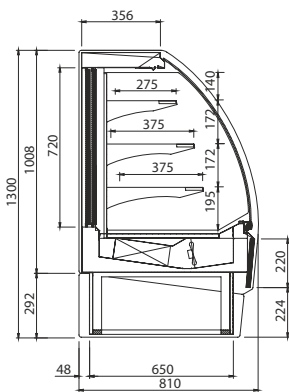

VNO R / DS

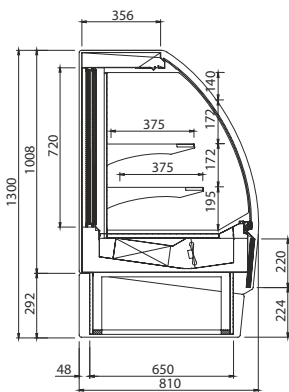



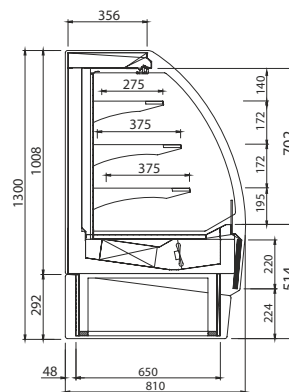

VON HT



VON SS

Vitrina expositora para cafetería y pastelería/ Pastry display case / Vitrine d'exposition pour cafétéria et pâtisserie

| MODELO MODELE MODÈLE |  VCO 9 |  VCO 12 |  VCO 15 |  VCO 18 |
|---|---|---|---|---|
| Precio Price Prix | 4.775 € | 5.279 € | 6.180 € | 6.645 € |
| Medidas / Measures / Mesures (mm) | 998 x 890 x 1455 mm. | 1310 x 890 x 1455 mm. | 1622 x 890 x 1455 mm. | 1935 x 890 x 1455 mm. |
| Temperatura Temperature Température (°C) | +2°C/+5°C | | | |
| Clase Climática Climatic class Classe climatique (°C) | 3 / 25°C | | | |
| Tensión/Frecuencia Electrical data Tension électrique | 230V/1ph/50Hz | | | |
| Controlador Controller Régulateur | Digital | | | |
| Material Material Matériel (EXT/INT) | Acero plastificado / Plastified galvanised steel / Acier galvanisé plastifié Plano exposición / Exhibition plan / Plan d'exposition: Acero plastif. negro/ Plastif. Stainless steel black/ Acier plastifié noire | | | |
| Aislamiento Isolation Isolation (mm) | 40kg/m ³ / Free CFC's / Zero ODP-GWP | | | |
| Capacidad Capacity Capacité (L) | 186 | 248 | 310 | 372 |
| Superficie exposición Surface exhibition Surface d'exposition (m ²) | 1.13 | 1.51 | 1.88 | 2.26 |
| Compresor Compressor Compresseur (HP) | 5/8 | 3/4 | 7/8 | 1 |
| Estantes Shelving Étagères | 1 | | | |
| Costados (2) Sides (2) Joues (2) (mm) | 30+30 (INCLUIDOS / INCLUDES / INCLUS) | | | |
| Sistema de frío Cooling System Système de froid | Ventilado / Ventilated / Ventilé | | | |
| Desescarche Defrost Dégivrage | Manual / Manual / Manuel | | | |
| Evaporación Evaporation Évaporation | Semiestática / Semistatic / Semiestatique | | | |
| Potencia Power Puissance (W) | 436 | 616 | 682 | 740 |
| Potencia frig. Cooling capacity Puissance Frig. (-10°C) | - | | | |
| Consumo Consumption Consommation (kWh/24h) | 6,3 | 9,02 | 10,3 | 11,8 |
| Refrigerante Refrigerant Gaz | R-290 | | | |
| Opcional Optional Options | - | | | |

Serie / Series / Série **COMBO**

+Info: www.infrico.com

VC015



← **Parte superior neutra**
Neutral countertop
Partie supérieure neutre

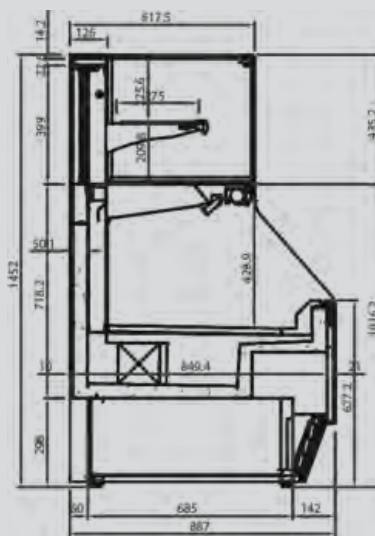







Laterales / Sides / Jous

Incluidos / Includes / Inclus



Vitrina expositora frío ventilado con reserva, modular, para cafetería y pastelería/ Refrigerated modular pastry display case with storage / Vitrine d'exposition froid ventilé avec réserve, modulaire, pour cafétéria et pâtisserie

| MODELO MODELE MODÈLE |  |  |  |  |  |  |
|---|--|---|---|--|---|---|
| Precio Price Prix | 3.346 € | 3.837 € | 4.404 € | 4.878 € | 6.095 € | 4.098 € |
| Medidas/Measures/ Mesures [mm] Sin costados/Without sides/Sans joues | 938 x 960 x 1220 mm. | 1250 x 960 x 1220 mm. | 1562 x 960 x 1220 mm. | 1875 x 960 x 1220 mm. | 2500 x 960 x 1220 mm. | 1250 x 960 x 1020 mm. |
| Temperatura Temperature [°C] Température | +4°C/+8°C | | | | | +7°C/+12°C |
| Clase Climática Climatic class [°C] Classe climatique | 3 / 25°C | | | | | |
| Tensión/Frecuencia Electrical data Tension électrique | 230V/1ph/50Hz | | | | | |
| Controlador Controller Régulateur | Digital | | | | | |
| Material Matériel [EXT/INT] | Ext: acero plastificado / Plastified steel / Acier plastifié Plano exposición / Exhibition plan / Plan d'exposition: Acero plastif. negro / Black plastif. Stainless steel / Acier plastifié noir | | | | | |
| Aislamiento Isolation [mm] Isolation | 40kg/m ³ / Free CFC's / Zero ODP-GWP | | | | | |
| Capacidad Capacity [L] Capacité | 106 | 141 | 177 | 212 | 283 | 141 |
| Superficie exposición Surface exhibition [m ²] Surface d'exposition | 0,13 | 0,17 | 0,22 | 0,26 | 0,35 | 0,17 |
| Compresor Compressor [HP] Compresseur | 1/3 | 1/3 | 1/2 | 3/4 | 1 | - |
| Estantes / Puertas Shelving / Doors Étagères / Portes | 1 Estante | | | | | |
| Costados [2] Sides [2] [mm] Joues [2] | 30 + 30 | | | | | |
| Sistema de frío Cooling System Système de froid | Ventilado / Ventilated / Ventilé | | | | | |
| Desescarche Defrost Dégivrage | Automático / Automatic / Automatique | | | | | |
| Evaporación Evaporation Évaporation | Ventilado / Ventilated / Ventilé | | | | | |
| Potencia Power [W] Puissance | 419 | 430 | 588 | 654 | 857 | 430 |
| Potencia frig. Cooling capacity [W A -10°C] Puissance Frig. | - | | | | | |
| Consumo Consumption [kWh/ 24h] Consommation | 6,04 | 6,2 | 8,5 | 9,4 | 12,3 | 6,2 |
| Refrigerante Refrigerant Gaz | R290 | | | | | |
| Opcional Optional Options | <p>Puertas correderas traseras Rear sliding doors Portes arrière coulissantes</p> <p>VMG 9 R PUEVMG9CT 227 €</p> <p>VMG 12 R PUEVMG12CT 274 €</p> <p>VMG 15 R PUEVMG15CT 268 €</p> <p>VMG 18 R PUEVMG18CT 386 €</p> <p>VMG 25 R PUEVMG25CT 479 €</p> | | | | | |

Laterales no incluidos en el precio
Side panels not included in price
Joues non incluses dans le prix

Serie / Series / Série **MAGNUS**

+Info: www.infrico.com



Laterales / Sides / Joues

| NO | |
|-----------------------------|----------------------------|
| Izquierdo Left Gauche | Derecho Right Droite |
| 249 € | 249 € |

Ext. Estándar / Standar / Standard

| | | |
|--------------------|--------------------|----------------|
| Ral 9016 | Ral 1001 | Ral 1018 |
| Ral 2003 | Ral 3003 | Ral 3020 |
| Ral 4007 | Design 3504035 | Ral 5015 |
| Design 1107060 | Ral 6002 | Design 2108025 |
| Ral 8017 | Ral 9006 | Ral 7016 |
| Nogal-Walnut-Noyer | Wengué-Wenge-Wenge | Ral 9017 |

Colores fuera de carta / Colors outside of letter / Couleurs spéciales, hors palette



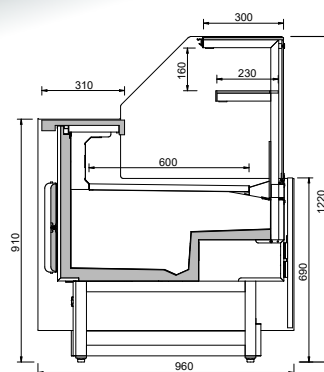

| RAL | | NO RAL | |
|--|--------------------------------|---|--------------------------------|
| Epoxi | Líquida/ Liquid/ Liquide | Epoxi | Líquida/ Liquid/ Liquide |
| 817 € | 508 € | Consultar / Consultar / Consultar | |
| [x unidad/x unit/x unité] | | | |
| +10 días laborables / +10 work days / +10 jours ouvrés | | Consultar / Consultar / Consultar | |



VMG RU



Vitrina expositora frío ventilado con reserva, modular, para cafetería y pastelería, cristal bajo/
Refrigerated modular pastry display case with storage, low glass /
Vitrine d'exposition froid ventilé avec réserve, modulaire, pour cafétéria et pâtisserie, verre bas

| MODELO MODELE MODÈLE |  |  |  |  |  |
|--|--|---|---|---|---|
| | VMG 9 RU LG | VMG 12 RU LG | VMG 15 RU LG | VMG 18 RU LG | VMG 25 RU LG |
| Precio Price Prix | 3.279 € | 3.760 € | 4.316 € | 4.781 € | 5.973 € |
| Medidas/Measures/ Mesures [mm] Sin costados/Without sides/Sans joues | 938 x 960 x 1020 mm. | 1250 x 960 x 1020 mm. | 1562 x 960 x 1020 mm. | 1875 x 960 x 1020 mm. | 2500 x 960 x 1020 mm. |
| Temperatura Temperature [°C] Température | +4°C/+8°C | | | | |
| Clase Climática Climatic class [°C] Classe climatique | 3 / 25°C | | | | |
| Tensión/Frecuencia Electrical data Tension électrique | 230V/1ph/50Hz | | | | |
| Controlador Controller Régulateur | Digital | | | | |
| Material Material [EXT/INT] Matériel | Ext: acero plastificado / Plastified steel / Acier plastifié Plano exposición / Exhibition plan / Plan d'exposition: Acero plastif. negro / Black plastif. Stainless steel / Acier plastifié noir | | | | |
| Aislamiento Isolation [mm] Isolation | 40kg/m ³ / Free CFC's / Zero ODP-GWP | | | | |
| Capacidad Capacity [L] Capacité | | 141 | 177 | 212 | 283 |
| Superficie exposición Surface exhibition [m ²] Surface d'exposition | 0,13 | 0,17 | 0,22 | 0,26 | 0,35 |
| Compresor Compressor [HP] Compresseur | | 1/3 | 1/2 | 3/4 | 1 |
| Estantes / Puertas Shelving / Doors Étagères / Portes | - | | | | |
| Costados [2] Sides [2] [mm] Joues [2] | 30 + 30 | | | | |
| Sistema de frío Cooling System Système de froid | Ventilado / Ventilated / Ventilé | | | | |
| Desescarche Defrost Dégivrage | Automático / Automatic / Automatique | | | | |
| Evaporación Evaporation Évaporation | Ventilado / Ventilated / Ventilé | | | | |
| Potencia Power [W] Puissance | 379 | 388 | 544 | 606 | 722 |
| Potencia frig. Cooling capacity [W A -10°C] Puissance Frig. | - | | | | |
| Consumo Consumption [kWh/ 24h] Consommation | 5,01 | 5,12 | 7,18 | 8,00 | 9,53 |
| Refrigerante Refrigerant Gaz | R290 | | | | |
| Opcional Optional Options | - | | | | |

Laterales no incluidos en el precio
Side panels not included in price
Joues non incluses dans le prix

Serie / Series / Série **MAGNUS**

+Info: www.infrico.com

VMG25LG

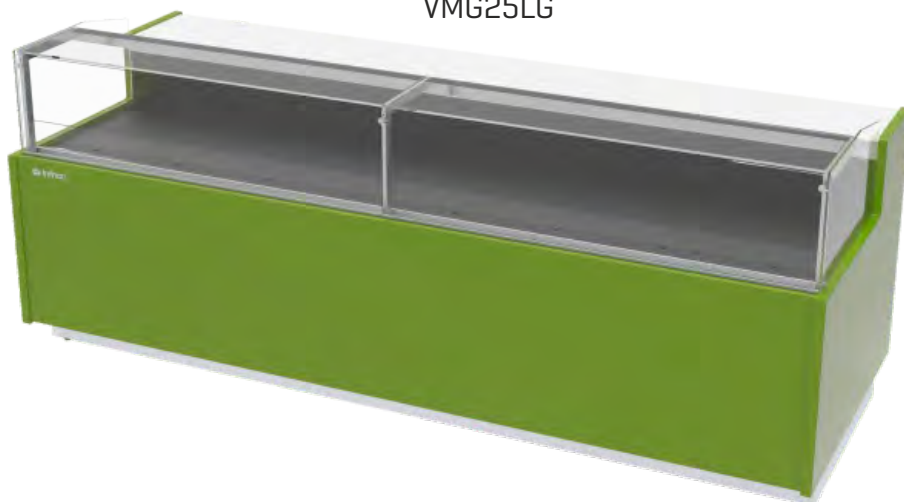

Laterales / Sides / Joues

| NO | |
|-----------------------------|----------------------------|
| Izquierdo Left Gauche | Derecho Right Droite |
| 233 € | 233 € |

Ext. Estándar / Standar / Standard

| | | |
|--------------------|--------------------|----------------|
| Ral 9016 | Ral 1001 | Ral 1018 |
| Ral 2003 | Ral 3003 | Ral 3020 |
| Ral 4007 | Design 3504035 | Ral 5015 |
| Design 1107060 | Ral 6002 | Design 2108025 |
| Ral 8017 | Ral 9006 | Ral 7016 |
| Nogal-Walnut-Noyer | Wengué-Wenge-Wenge | Ral 9017 |

Colores fuera de carta / Colors outside of letter / Couleurs spéciales, hors palette



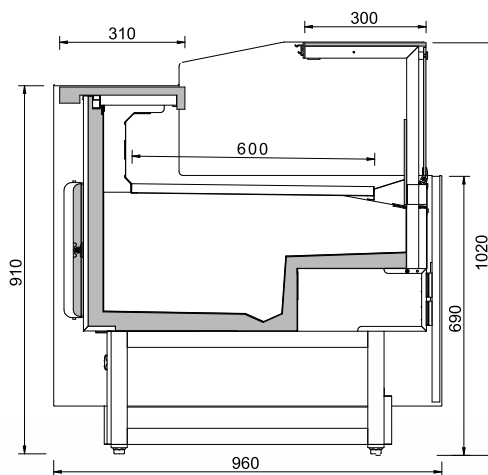

| RAL | | NO RAL | |
|--|--------------------------------|---|--------------------------------|
| Epoxi | Líquida/ Liquid/ Liquide | Epoxi | Líquida/ Liquid/ Liquide |
| 817 € | 508 € | Consultar / Consulter / Consulter | |
| [x unidad/x unit/x unité] | | | |
| +10 días laborables / +10 work days / +10 jours ouvrés | | Consultar / Consulter / Consulter | |



VMG LG



Vitrina expositora frío ventilado con reserva, modular, para cafetería y pastelería / Refrigerated modular pastry display case with storage / Vitrine d'exposition froid ventilé avec réserve, modulaire, pour cafétéria et pâtisserie

| MODELO MODELE MODÈLE |  |  |  |  |  |
|---|---|---|--|---|---|
| | VMG 90 AARU | VMG 90 ACRU | VMG 90 ARRU | VMG 45 AARU | VMG 45 ACRU |
| Precio Price Prix | 6.445 € | 7.445 € | 6.468 € | 4.386 € | 4.779 € |
| Medidas/Measures/ Mesures [mm] Sin costados/Without sides/Sans joues | 1365 x 960 x 1220 mm. | 1750 x 960 x 1220 mm. | 1365 x 960 x 1220 mm. | 1180 x 960 x 1220 mm. | 1365 x 960 x 1220 mm. |
| Temperatura Temperature [°C] Température | +4°C/+8°C | | | | |
| Clase Climática Climatic class [°C] Classe climatique | 3 / 25°C | | | | |
| Tensión/Frecuencia Electrical data Tension électrique | 230V/1ph/50Hz | | | | |
| Controlador Controller Régulateur | Digital | | | | |
| Material Material [EXT/INT] Matériel | Ext: acero plastificado / Plastified steel / Acier plastifié Plano exposición / Exhibition plan / Plan d'exposition: Acero plastif. negro / Black plastif. Stainless steel / Acier plastifié noir | | | | |
| Aislamiento Isolation [mm] Isolation | 40kg/m ³ / Free CFC's / Zero ODP-GWP | | | | |
| Capacidad Capacity [L] Capacité | - | | | | |
| Superficie exposición Surface exhibition [m ²] Surface d'exposition | 0,9 | 1,2 | 1,1 | 0,8 | 0,9 |
| Compresor Compressor [HP] Compresseur | 1/2 | | | | |
| Estantes / Puertas Shelving / Doors Étagères / Portes | 1 | | | | |
| Costados [2] Sides [2] [mm] Joues [2] | 30 + 30 | | | | |
| Sistema de frío Cooling System Système de froid | Ventilado / Ventilated / Ventilé | | | | |
| Desescarche Defrost Dégivrage | Automático / Automatic / Automatique | | | | |
| Evaporación Evaporation Évaporation | Ventilado / Ventilated / Ventilé | | | | |
| Potencia Power [W] Puissance | 580 | 594 | 594 | 548 | 580 |
| Potencia frig. Cooling capacity [W A -10°C] Puissance Frig. | - | | | | |
| Consumo Consumption [kWh/ 24h] Consommation | 8,3 | 8,5 | 8,5 | 7,9 | 8,3 |
| Refrigerante Refrigerant Gaz | R290 | | | | |
| Opcional Optional Options | <p>Puertas correderas traseras Rear sliding doors Portes arrières coulissantes</p> <p>VMG 90 AARU PUEVMG90AACT 453 € VMG 90 ACRU PUEVMG90ACCT 491 € VMG 90 ARRU PUEVMG90ARCT 332 € VMG 45 AARU PUEVMG45AACT 298 € VMG 45 ACRU PUEVMG45ACCT 314 €</p> | | | | |

Laterales no incluidos en el precio
Side panels not included in price
Joues non incluses dans le prix

Serie / Series / Série **MAGNUS**

+Info: www.infrico.com

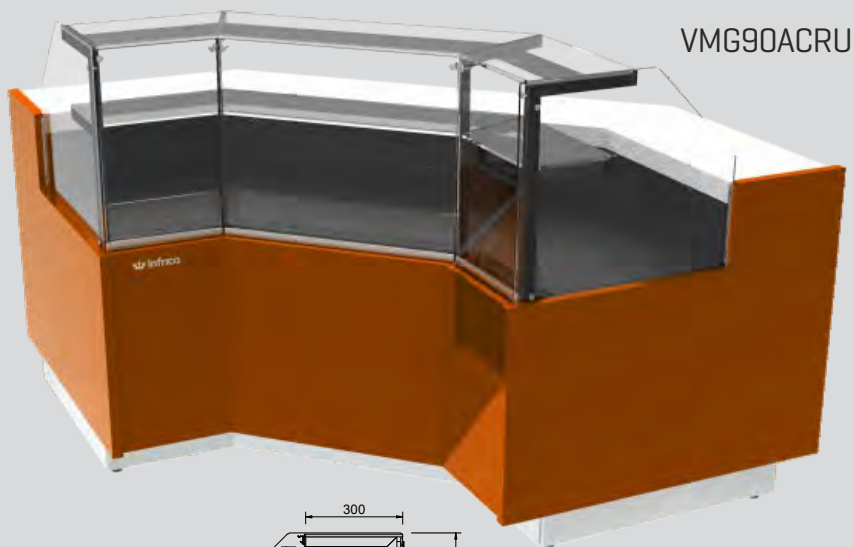

VMG90ACRU

Laterales / Sides / Joues

| NO | |
|-----------------------------|----------------------------|
| Izquierdo Left Gauche | Derecho Right Droite |
| 249 € | 249 € |

Ext. Estándar / Standar / Standard

| | | |
|--------------------|--------------------|----------------|
| Ral 9016 | Ral 1001 | Ral 1018 |
| Ral 2003 | Ral 3003 | Ral 3020 |
| Ral 4007 | Design 3504035 | Ral 5015 |
| Design 1107060 | Ral 6002 | Design 2108025 |
| Ral 8017 | Ral 9006 | Ral 7016 |
| Nogal-Walnut-Noyer | Wengué-Wenge-Wenge | Ral 9017 |

Colores fuera de carta /
Colors outside of letter /
Couleurs spéciales, hors palette

| RAL | | NO RAL | |
|--|--------------------------------|---|--------------------------------|
| Epoxi | Líquida/ Liquid/ Liquide | Epoxi | Líquida/ Liquid/ Liquide |
| 817 € | 508 € | Consultar / Consultar / Consulter | |
| [x unidad/x unit/x unité] | | | |
| +10 días laborables / +10 work days / +10 jours ouvrés | | Consultar / Consultar / Consulter | |

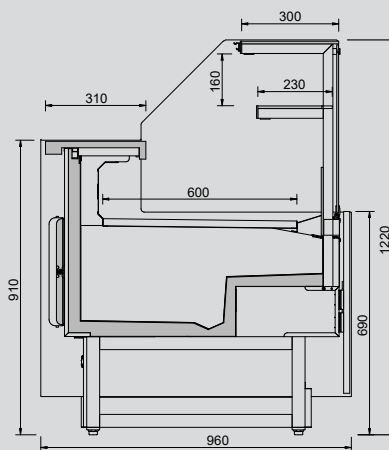







VMG



Vitrina expositora modular neutra (panera) /
Neutral modular display case /
 Vitrine d'exposition modulaire neutre

Mueble caja /
Counter case /
 Meuble caisse

| MODELO MODELE MODÈLE | VITRINA / DISPLAY CASE / VITRINE | | MUEBLE CAJA / COUNTER CASE / MEUBLE CAISSE | | | |
|---|--|--|--|---|--|--|
| |  VMG 9 P |  VMG 12 P |  VMG 90 AAM |  VMG 90 ACM |  VMG 45 AAM |  VMG 45 ACM |
| Precio Price Prix | 3.073 € | 3.573 € | 2.961 € | 3.881 € | 2.402 € | 2.825 € |
| Medidas/Measures/ Mesures (mm) Sin costados/Without sides/Sans joues | 938 x 960 x 1345 mm. | 1250 x 960 x 1345 mm. | 1365 x 960 x 1345 mm. | 1750 x 960 x 1345 mm. | 1180 x 960 x 920 mm. | 1365 x 960 x 920 mm. |
| Temperatura Temperature (°C) Température | - | | | | | |
| Clase Climática Climatic class (°C) Classe climatique | 3 / 25°C | | | | | |
| Tensión/Frecuencia Electrical data Tension électrique | - | | 230V/1ph/50Hz | | | |
| Controlador Controller Régulateur | - | | | | | |
| Material Matériel (EXT/INT) | Ext: acero plastificado / Plastified steel / Acier plastifié Plano exposición / Exhibition plan / Plan d'exposition: Acero plastif. negro / Black plastif. Stainless steel / Acier plastifié noir | | | | | |
| Aislamiento Isolation (mm) Isolation | 40kg/m ³ / Free CFC's / Zero ODP-GWP | | | | | |
| Capacidad Capacity (L) Capacité | - | | | | | |
| Superficie exposición Surface exhibition (m ²) Surface d'exposition | 0,6 | 0,8 | - | | | |
| Compresor Compressor (HP) Compresseur | - | | - | | | |
| Estantes Shelving Étagères | 1 | | - | | | |
| Costados (2) Sides (2) (mm) Joues (2) | 30 + 30 | | | | | |
| Sistema de frío Cooling System Système de froid | - | | | | | |
| Desescarche Defrost Dégivrage | - | | | | | |
| Evaporación Evaporation Évaporation | - | | | | | |
| Potencia Power (W) Puissance | 24 | 30 | 7 | 10 | 5 | 7 |
| Potencia frig. Cooling capacity (W A -10°C) Puissance Frig. | - | | | | | |
| Consumo Consumption (kWh/ 24h) Consommation | 0,4 | 0,5 | 0,1 | 0,2 | 0,1 | 0,2 |
| Refrigerante Refrigerant Gaz | - | | | | | |
| Opcional Optional Options | - | | | | | |

Serie / Series / Série **MAGNUS**

+Info: www.infrico.com

VMG12P



Laterales / Sides / Jous

Incluidos / Includes / Inclus

Ext. Estándar / Standar / Standard

| | | |
|--------------------|--------------------|----------------|
| Ral 9016 | Ral 1001 | Ral 1018 |
| Ral 2003 | Ral 3003 | Ral 3020 |
| Ral 4007 | Design 3504035 | Ral 5015 |
| Design 1107060 | Ral 6002 | Design 2108025 |
| Ral 8017 | Ral 9006 | Ral 7016 |
| Nogal-Walnut-Noyer | Wengué-Wenge-Wenge | Ral 9017 |

Colores fuera de carta / Colors outside of letter / Couleurs spéciales, hors palette



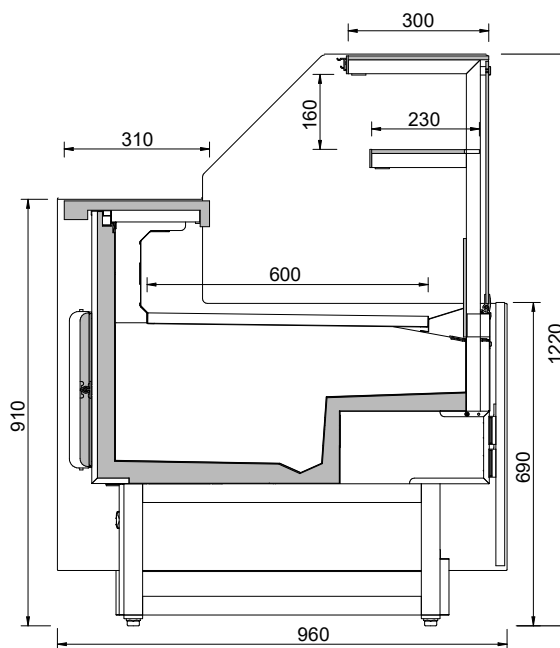

| RAL | | NO RAL | |
|--|--------------------------------|---|--------------------------------|
| Epoxi | Líquida/ Liquid/ Liquide | Epoxi | Líquida/ Liquid/ Liquide |
| 817 € | 508 € | Consultar / Consulter / Consulter | |
| [x unidad/x unit/x unité] | | | |
| +10 días laborables / +10 work days / +10 jours ouvrés | | Consultar / Consulter / Consulter | |



VMG P

Mueble caja /
Counter case /
Meuble caisse

Serie / Series / Série **MAGNUS**

| MODELO MODELE MODÈLE |  VMG 9 C |  VMG 12 M |  VMG 18 M |  VMG 12 MHD |
|---|--|---|---|---|
| Precio Price Prix | 2.248 € | 2.449 € | 2.890 € | 2.576 € |
| Medidas/Measures/ Mesures [mm] Sin costados/Without sides/Sans joues | 938 x 960 x 690 mm. | 1250 x 960 x 690 mm. | 1875 x 960 x 690 mm. | 1250 x 960 x 736 mm. |
| Costados [2] Sides [2] Joues [2] [mm] | 30 + 30 | | | |

VMG12MHD



VMG12M

Laterales / Sides / Jous

Incluidos / Includes / Inclus

Ext. Estándar / Standar / Standard



| | | |
|--------------------|--------------------|----------------|
| Ral 9016 | Ral 1001 | Ral 1018 |
| Ral 2003 | Ral 3003 | Ral 3020 |
| Ral 4007 | Design 3504035 | Ral 5015 |
| Design 1107060 | Ral 6002 | Design 2108025 |
| Ral 8017 | Ral 9006 | Ral 7016 |
| Nogal-Walnut-Noyer | Wengué-Wenge-Wenge | Ral 9017 |

Colores fuera de carta / Colors outside of letter / Couleurs spéciales, hors palette

| RAL | | NO RAL | |
|--|--------------------------------|---|--------------------------------|
| Epoxi | Líquida/ Liquid/ Liquide | Epoxi | Líquida/ Liquid/ Liquide |
| 817 € | 508 € | Consultar / Consultar / Consulter | |
| (x unidad/x unit/x unité) | | | |
| +10 días laborables / +10 work days / +10 jours ouvrés | | Consultar / Consultar / Consulter | |



Vitrina expositora helados / Gelato display case / Vitrine d'exposition pour glace

| MODELO MODELE MODÈLE |  VCB 12 UH |  VCB 15 UH |  VCB 18 UH |
|---|---|---|--|
| Precio Price Prix | 8.900 € | 10.399 € | 11.265 € |
| Medidas/Measures/ Mesures [mm] Sin costados/Without sides/Sans joues | 1250 x 1052 x 1200 mm. | 1562 x 1052 x 1200 mm. | 1875 x 1052 x 1200 mm. |
| Temperatura Temperature [°C] Température | -15°C/-18°C | | |
| Clase Climática Climatic class [°C] Classe climatique | 7 / 35°C | | |
| Tensión/Frecuencia Electrical data Tension électrique | 230V/1ph/50Hz | | |
| Controlador Controller Régulateur | Digital | | |
| Material Matériel [EXT/INT] | Acero plastificado / Plastified galvanised steel / Acier galvanisé plastifié Plano exposición / Exhibition plan / Plan d'exposition: Inox Aisi 304 | | |
| Aislamiento Isolation [mm] | 40kg/m ³ / Free CFC's / Zero ODP-GWP | | |
| Capacidad Capacity [L] Capacité | 182 | 228 | 274 |
| Superficie exposición Surface exhibition [m ²] Surface d'exposition | 0,96 | 1,20 | 1,49 |
| Compresor Compressor [HP] Compresseur | 1 1/4 | 1 1/4 + 1 | 1 1/4 + 1 |
| Bandejas Shelving Bacs | 8 / 14 | 10 / 16 | 14 / 20 |
| Costados [2] Sides [2] [mm] Joues [2] | 20 + 20 | | |
| Sistema de frío Cooling System Système de froid | Ventilado / Ventilated / Ventilé | | |
| Desescarche Defrost Dégivrage | Gas caliente / Hot gas / Gaz chaud | | |
| Evaporación Evaporation Évaporation | Ventilado / Ventilated / Ventilé | | |
| Potencia Power [W] Puissance | 1250 | 1570 | 1640 |
| Potencia frig. Cooling capacity [W A -10°C] Puissance Frig. | - | | |
| Consumo Consumption [kWh/ 24h] Consommation | 19,7 | 28,9 | 30,8 |
| Refrigerante Refrigerant Gaz | R-290 | | |
| Opcional Optional Options | 230v/1ph/60 Hz +6% | | |
| | Combinación de bandejas / Tray combinations / Combinaisons de bacs | | |
| | | (501X36) x 8uds. 359 € | VCB12UH |
| | | (501X32) x 14uds. 663 € | |
| | | (501X36) x 10uds. 446 € | VCB15UH |
| | | (501X32) x 16uds. 756 € | |
| | | (501X36) x 14uds. 621 € | VCB18UH |
| | | (501X32) x 20uds. 942 € | |
| | Puertas correderas traseras / Rear sliding doors / Portes arrière coulissantes | Puertas correderas traseras / Rear sliding doors / Portes arrière coulissantes | Puertas correderas traseras / Rear sliding doors / Portes arrière coulissantes |
| | PUEVCB12CT 284 € | PUEVCB15CT 285 € | PUEVCB18CT 335 € |

Serie / Series / Série **CORAL**

+Info: www.infrico.com

VCB15UH

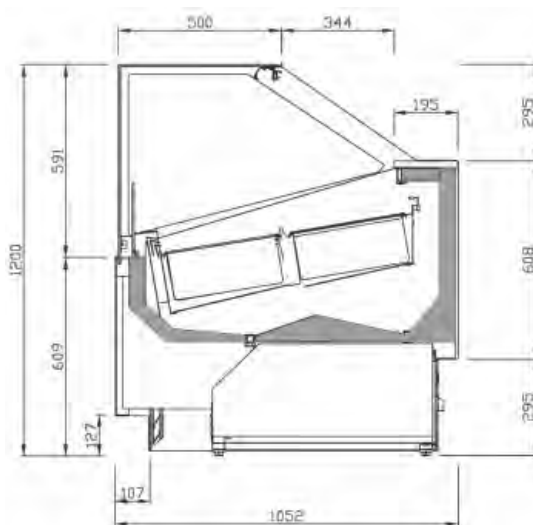

VCB12UH

{501X36}
x 8 uds.

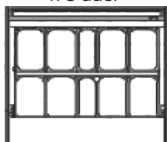

8

{501X32}
x 14 uds.

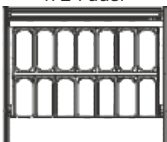

14

VCB18UH

{501X36}
x 10 uds.

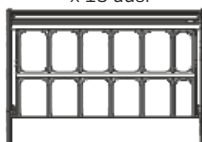

10

{501X32}
x 16 uds.

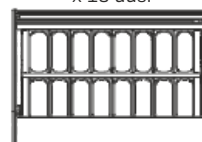

16

VCB18UH

{501X36}
x 14 uds.

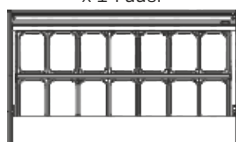

14

{501X32}
x 20 uds.

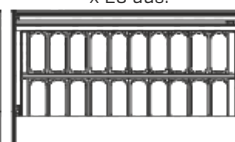

20



Laterales / Sides / Joints

Incluidos / Includes / Inclus

Ext. Estándar / Standar / Standard

| | | |
|----------------|----------------|----------------|
| Ral 9016 | Ral 1001 | Ral 1018 |
| Ral 2003 | Ral 3003 | Ral 3020 |
| Ral 4007 | Design 3504035 | Ral 5015 |
| Design 1107060 | Ral 8002 | Design 2108025 |
| Ral 8017 | Ral 9006 | Ral 7016 |
| Ral 9017 | | |

Colores fuera de carta / Colors outside of letter / Couleurs spéciales, hors palette

| RAL | | NO RAL | |
|--|--------------------------------|---|--------------------------------|
| Epoxi | Líquida/ Liquid/ Liquide | Epoxi | Líquida/ Liquid/ Liquide |
| 817 € | 508 € | Consultar / Consultar / Consulter | |
| (x unidad/x unit/x unité) | | Consultar / Consultar / Consulter | |
| +10 días laborables / +10 work days / +10 jours ouvrés | | Consultar / Consultar / Consulter | |

Los datos técnicos están sujetos a posibles variaciones que serán actualizadas periódicamente en las fichas técnicas del producto, disponibles en la web / The technical data are subject to possible variations that will be updated periodically in the technical data sheets of the product, which are available on the website / Les données techniques peuvent varier et seront actualisées dans les fiches techniques du produit, disponibles sur le site web.

Vitrina expositora helados / Gelato display case / Vitrine d'exposition pour glace



VAR 12 H



VAR 15 H



VAR 18 H

| MODELO MODELE MODÈLE | VAR 12 H | VAR 15 H | VAR 18 H | | | | | | | | | | | | | | | |
|---|---|------------------------------|------------------------------|------------------|--------------|---------------|-------------------|--------------|-------------------|--------------|---------------|-------------------|--------------|-------------------|--------------|---------------|-------------------|--------------|
| Precio Price Prix | 8.783 € | 10.662 € | 11.211 € | | | | | | | | | | | | | | | |
| Medidas/Measures/ Mesures [mm] Sin costados/Without sides/Sans joues | 1250 x 1145 x 1320 mm. | 1562 x 1145 x 1320 mm. | 1875 x 1145 x 1320 mm. | | | | | | | | | | | | | | | |
| Temperatura Temperature [°C] Température | -15°C/-18°C | | | | | | | | | | | | | | | | | |
| Clase Climática Climatic class [°C] Classe climatique | 7 / 35°C | | | | | | | | | | | | | | | | | |
| Tensión/Frecuencia Electrical data Tension électrique | 230V/1ph/50Hz | | | | | | | | | | | | | | | | | |
| Controlador Controller Régulateur | Digital | | | | | | | | | | | | | | | | | |
| Material Material [EXT/INT] Matériel | Acero plastificado / Plastified galvanised steel / Acier galvanisé plastifié Plano exposición / Exhibition plan / Plan d'exposition: Inox Aisi 304 | | | | | | | | | | | | | | | | | |
| Aislamiento Isolation [mm] Isolation | 40kg/m ³ / Free CFC's / Zero ODP-GWP | | | | | | | | | | | | | | | | | |
| Capacidad Capacity [L] Capacité | 182 | 228 | 274 | | | | | | | | | | | | | | | |
| Superficie exposición Surface exhibition [m ²] Surface d'exposition | 0,96 | 1,26 | 1,44 | | | | | | | | | | | | | | | |
| Compresor Compressor [HP] Compresseur | 1 1/4 | 1 1/4 + 1 | 1 1/4 + 1 | | | | | | | | | | | | | | | |
| Bandejas Shelving Bacs | 8 / 14 | 10 / 16 | 14 / 20 | | | | | | | | | | | | | | | |
| Costados [2] Sides [2] [mm] Joues [2] | 40 +40 | | | | | | | | | | | | | | | | | |
| Sistema de frío Cooling System Système de froid | Ventilado / Ventilated / Ventilé | | | | | | | | | | | | | | | | | |
| Desescarche Defrost Dégivrage | Gas caliente / Hot gas / Gaz chaud | | | | | | | | | | | | | | | | | |
| Evaporación Evaporation Évaporation | Ventilado / Ventilated / Ventilé | | | | | | | | | | | | | | | | | |
| Potencia Power [W] Puissance | 1020 | 1536 | 1640 | | | | | | | | | | | | | | | |
| Potencia frig. Cooling capacity [W A -10°C] Puissance Frig. | - | | | | | | | | | | | | | | | | | |
| Consumo Consumption [kWh/ 24h] Consommation | 19,7 | 28,9 | 30,8 | | | | | | | | | | | | | | | |
| Refrigerante Refrigerant Gaz | R-290 | | | | | | | | | | | | | | | | | |
| Opcional Optional Options | <p>230v/1ph/60 Hz +6%</p> <p>Combinación de bandejas Tray combinations Combinaisons de bacs</p> <table border="0"> <tr> <td>[501X36] x 8uds.</td> <td>359 €</td> <td rowspan="2"> VAR12H</td> </tr> <tr> <td>[501X32] x 14uds.</td> <td>663 €</td> </tr> <tr> <td>[501X36] x 10uds.</td> <td>446 €</td> <td rowspan="2"> VAR15H</td> </tr> <tr> <td>[501X32] x 16uds.</td> <td>756 €</td> </tr> <tr> <td>[501X36] x 14uds.</td> <td>621 €</td> <td rowspan="2"> VAR18H</td> </tr> <tr> <td>[501X32] x 20uds.</td> <td>942 €</td> </tr> </table> | | | [501X36] x 8uds. | 359 € | VAR12H | [501X32] x 14uds. | 663 € | [501X36] x 10uds. | 446 € | VAR15H | [501X32] x 16uds. | 756 € | [501X36] x 14uds. | 621 € | VAR18H | [501X32] x 20uds. | 942 € |
| [501X36] x 8uds. | 359 € | VAR12H | | | | | | | | | | | | | | | | |
| [501X32] x 14uds. | 663 € | | | | | | | | | | | | | | | | | |
| [501X36] x 10uds. | 446 € | VAR15H | | | | | | | | | | | | | | | | |
| [501X32] x 16uds. | 756 € | | | | | | | | | | | | | | | | | |
| [501X36] x 14uds. | 621 € | VAR18H | | | | | | | | | | | | | | | | |
| [501X32] x 20uds. | 942 € | | | | | | | | | | | | | | | | | |

Serie / Series / Série **ARIES**

+Info: www.infrico.com

VAR15H

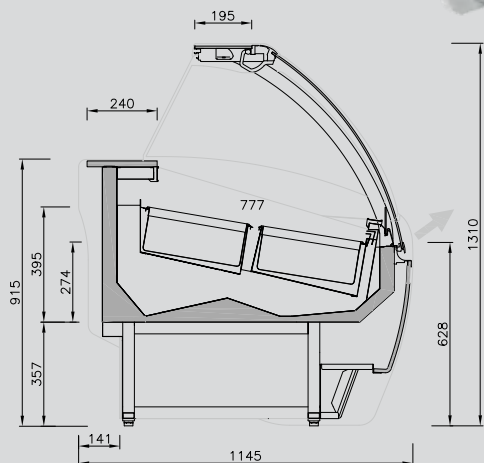

VAR15H



Cristal elevable
Lift-up glass
Vitre relevable



Laterales / Sides / Joues

Incluidos / Includes / Inclus

Ext. Estándar / Standar / Standard

| | | |
|----------------|----------------|----------------|
| Ral 9016 | Ral 1001 | Ral 1018 |
| Ral 2003 | Ral 3003 | Ral 3020 |
| Ral 4007 | Design 3504035 | Ral 5015 |
| Design 1107060 | Ral 6002 | Design 2108025 |
| Ral 8017 | Ral 9006 | Ral 7016 |
| Ral 9017 | | |

VAR12H



8 [501X36] x 8 uds. 14 [501X32] x 14 uds.

VAR15H



10 [501X36] x 10 uds. 16 [501X32] x 16 uds.

VAR18H



14 [501X36] x 14 uds. 20 [501X32] x 20 uds.

Combinación de bandejas
Combination of trays
Combinaison de bacs



Cortina nocturna
Night curtain
Rideau de nuit







Bandeja evaporativa extraíble
Removable evaporation tray
Bac d'évaporation extractable



Colores fuera de carta / Colors outside of letter / Couleurs spéciales, hors palette

| RAL | | NO RAL | |
|--|--------------------------------|---|--------------------------------|
| Epoxi | Líquida/ Liquid/ Liquide | Epoxi | Líquida/ Liquid/ Liquide |
| 817 € | 508 € | Consultar / Consultar / Consulter | |
| [x unidad/x unit/x unité] | | | |
| +10 días laborables / +10 work days / +10 jours ouvrés | | Consultar / Consultar / Consulter | |

Vitrina estática expositora helados / Gelato static display case / Vitrine statique d'exposition pour glace

| MODELO MODELE MODÈLE |  |  |  |  |
|--|---|---|---|---|
| | VBZ 12U | VBZ 15U | VBZ 12 SU | VBZ 15 SU |
| Precio Price Prix | 4.320 € | 4.677 € | 3.710 € | 4.027 € |
| Medidas Measures Mesures (mm) | 1310 x 920 x 1350 mm. | 1622 x 920 x 1350 mm. | 1310 x 670 x 1350 mm. | 1622 x 670 x 1350 mm. |
| Temperatura Temperature Température (°C) | -15°C/-18°C | | | |
| Clase Climática Climatic class Classe climatique (°C) | 7 / 35°C | | | |
| Tensión/Frecuencia Electrical data Tension électrique | 230V/1ph/50Hz | | | |
| Controlador Controller Régulateur | Digital | | | |
| Material Material Matériel (EXT/INT) | Acero plastificado / Plastified galvanised steel / Acier galvanisé plastifié Plano exposición / Exhibition plan / Plan d'exposition: Inox Aisi 304 | | | |
| Aislamiento Isolation Isolation (mm) | 40kg/m ³ / Free CFC's / Zero ODP-GWP | | | |
| Capacidad Capacity Capacité (L) | 289 | 361 | 210 | 263 |
| Superficie exposición Surface exhibition Surface d'exposition (m ²) | 0,94 | 1,41 | 0,50 | 0,63 |
| Compresor Compressor Compresseur (HP) | 1 | | 3/4 | |
| Bandejas Shelving Bacs | 10+10 | 13+13 | 7+7 | 9+9 |
| Costados [2] Sides [2] Joues [2] (mm) | 30 +30 | | | |
| Sistema de frío Cooling System Système de froid | Estático / Static / Statique | | | |
| Desescarche Defrost Dégivrage | Gas caliente / Hot gas / Gaz chaud | | | |
| Evaporación Evaporation Évaporation | Ventilado / Ventilated / Ventilé | | | |
| Potencia Power Puissance (W) | 480 | 484 | 432 | 436 |
| Potencia frig. Cooling capacity Puissance Frig. (W A -10°C) | - | | | |
| Consumo Consumption Consommation (kWh/ 24h) | 11,5 | 13,6 | 9,9 | 11,5 |
| Refrigerante Refrigerant Gaz | R-290 | | | |
| Opcional Optional Options | Ruedas de serie Tray combinations Combinaisons de bacs | | | |
| | Combinación de bandejas Tray combinations Combinaisons de bacs | | | |
| | VBZ12 [501X32] x 10 uds. 416 € | VBZ15 [501X32] x 13 uds. 416 € | VBZ12S [501X32] x 7 uds. 291 € | VBZ15S [501X32] x 9 uds. 291 € |

Serie / Series / Série **IBIZA**

+Info: www.infrico.com

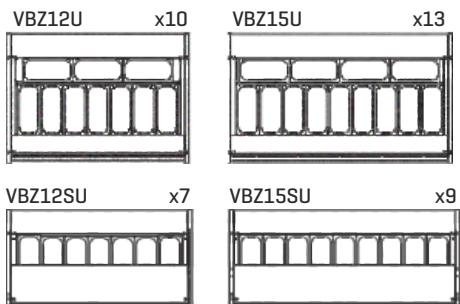

Laterales / Sides / Joutes

Incluidos / Includes / Inclus

Ext. Estándar / Standar / Standard

| | | |
|----------------|----------------|----------------|
| Ral 9016 | Ral 1001 | Ral 1018 |
| Ral 2003 | Ral 3003 | Ral 3020 |
| Ral 4007 | Design 3504035 | Ral 5015 |
| Design 1107060 | Ral 6002 | Design 2108025 |
| Ral 8017 | Ral 9006 | Ral 7016 |
| Ral 9017 | | |

Colores fuera de carta / Colors outside of letter / Couleurs spéciales, hors palette

| RAL | | NO RAL | |
|--|--------------------------------|---|--------------------------------|
| Epoxi | Líquida/ Liquid/ Liquide | Epoxi | Líquida/ Liquid/ Liquide |
| 817 € | 508 € | Consultar / Consultar / Consulter | |
| (x unidad/x unit/x unité) | | | |
| +10 días laborables / +10 work days / +10 jours ouvrés | | Consultar / Consultar / Consulter | |

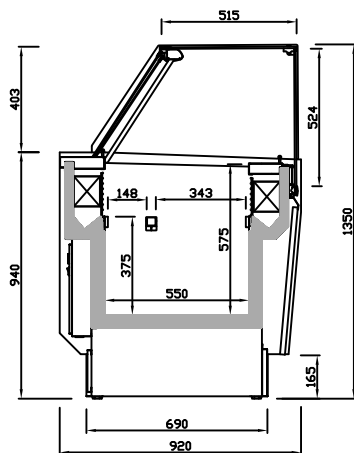

VBZ U



PHOTOBOOK

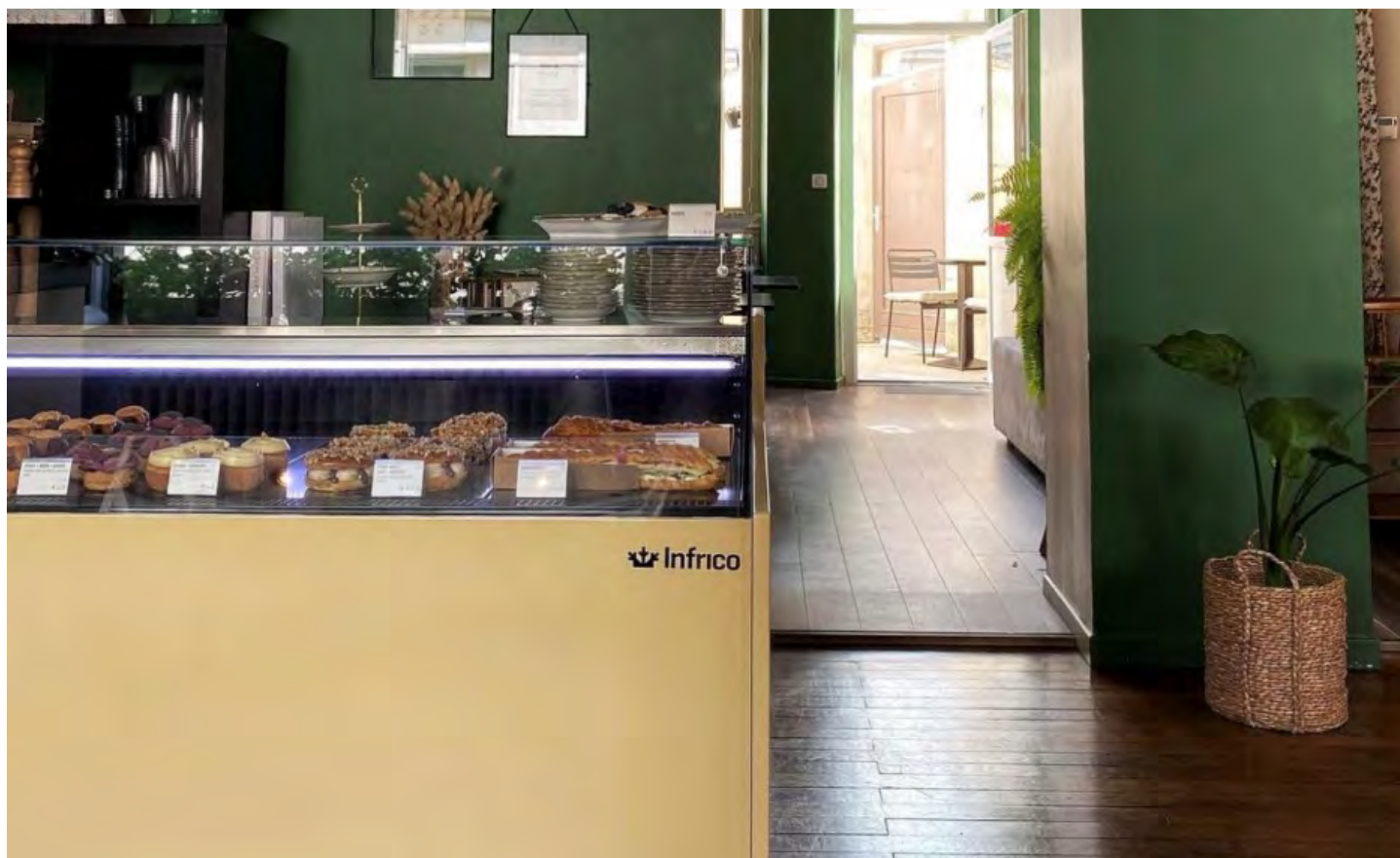

+Info: www.infrico.com

osmarc.es



Los datos técnicos están sujetos a posibles variaciones que serán actualizadas periódicamente en las fichas técnicas del producto, disponibles en la web /
The technical data are subject to possible variations that will be updated periodically in the technical data sheets of the product, which are available on the website /
Les données techniques peuvent varier et seront actualisées dans les fiches techniques du produit, disponibles sur le site web.

Horeca

Horeca / Négoce





12. Horeca

Horeca Equipment / Négoce

| | | | |
|------------|---|--|----------------|
| NEW | FHC ICE CUBE | Dispensador/Fabricador de hielo cubito macizo Dispenser/Ice maker solid cube / Dispensateur/Machines à glaçons solides | 492-493 |
| | FHCM/SPLIT ICE CUBE | Fabricador de hielo cubito macizo Ice maker solid cube / Machines à glaçons solides | 493 |
| | FHC B-CUBE | Fabricador de hielo cubito macizo cuadrado Ice maker square solid cube / Machines à glaçons solides carrés | 494 |
| | IMF | Fabricador de hielo hueco Hollow ice maker / Machines à glaçons creux | 495 |
| | FHTB/ FHTBM PEBBLES | Fabricador de hielo troceado Cubed ice maker / Machines à glaçons en morceau | 496-497 |
| | FHT/FHTM ICE FLAKES | Fabricador de hielo troceado Cubed ice maker / Machines à glaçons en morceau | 498 |
| | FHTM/SPLIT ICE FLAKES | Fabricador de hielo troceado Cubed ice maker / Machines à glaçons en morceau | 499 |
| | FHES COLD FLAKES | Fabricador de hielo en escama Flake ice maker / Machines à glaçons à pailletes | 500 |
| | FHES/SPLIT COLD FLAKES | Fabricador de hielo en escama Flake ice maker / Machines à glaçons à pailletes | 501 |
| | DPE/DI | Almacén fabricante de hielo Ice maker storage / Stockage pour machines à glaçons | 502 |
| | ROLLER BIN/ DOBLE ROLLER BIN | Almacén de hielo Ice storage / Stockage pour glaçons | 509 |

| | | |
|---|--|------------------|
| Serie / Series / Série | | |
| ELECTROMECÁNICA ELECTROMECHANICAL ÉLECTROMÉCANIQUE | Lavavasos y lavaplatos Glasswasher, dishwasher and hood dishwasher / Lave-vaisselle | 504 - 507 |
| Serie / Series / Série | | |
| ELECTRÓNICA ELECTRONIC ÉLECTRONIQUE | Lavavasos y lavaplatos Glasswasher, dishwasher and hood dishwasher / Lave-vaisselle | 508 - 511 |
| Serie / Series / Série | | |
| | Accesorios lavavasos y lavaplatos cúpula Dishwasher accessories / Accessoires lave-vaisselle | 512 - 513 |
| Serie / Series / Série | | |
| LP | Lavautensilios y lavaperolas Dishwasher / Lave-ustensiles | 514 - 515 |
| Serie / Series / Série | | |
| TA | Túneles de lavado y arrastre Rack conveyor dishwasher / Tunnels de lavage | 516 - 517 |
| Serie / Series / Série | | |
| | Accesorios Túnel de lavado Rack conveyor dishwasher accessories / Accessoires tunnels de lavage | 518 - 519 |
| Serie / Series / Série | | |
| HF | Congelador tapa abatible - puerta corredera Lid chest freezer - Sliding doors conservator Congélateur avec couvercle battant - coulissant | 520 - 521 |
| Serie / Series / Série | | |
| NEW | UL / PRO Congelador -70 / -60° Freezer -70 / -60° Congélateur -70 / -60° | 528 - 529 |
| Serie / Series / Série | | |
| IL / CHE | Conservadora expositora puerta cristal Horizontal freezer with glass lid / Conservateur panoramique pour surgelés | 524 - 525 |



12. Horeca

Horeca Equipment / Négoce

| | | |
|--|--|------------------|
| Serie / Series / Série | | |
| EHC EHC D EHC R | Conservadora expositora puerta cristal curvada Conservative of curved glass crystal door Conservateur panoramique pour surgelés | 526 - 527 |
| Serie / Series / Série | | |
| NEW EHC VISION VSC | Conservadora expositora horizontal Visión compresor VSC Vision horizontal display conservative, VSC compressor Conservateur panoramique Vision, compresseur VSC | 528 - 529 |
| Serie / Series / Série | | |
| MINI ARMARIO | Armario de refrigeración y congelación Chillers and freezers / Congélateur vertical | 530 - 531 |
| Serie / Series / Série | | |
| NEW 400L | Armario de refrigeración y congelación 400L 400L Chillers and freezers / Congélateur vertical 400L | 532 - 533 |
| Serie / Series / Série | | |
| CV | Congelador vertical Vertical freezer / Congélateur vertical | 534 - 535 |
| Serie / Series / Série | | |
| LO LO SOFT AIR LO NO-FROST | Armario expositor heladería y pastelería Exhibiting cupboard for ice-cream and pastry Armoire d'exposition pour la glace et la pâtisserie | 536 - 541 |
| Serie / Series / Série | | |
| VITRA VITRA SOFT AIR VITRA NO-FROST | Armario expositor heladería y pastelería Exhibiting cupboard for ice-cream and pastry Armoire d'exposition pour la glace et la pâtisserie | 542 - 549 |
| Serie / Series / Série | | |
| NEW HDC | Murales calientes / Hot display cabinet / Murale d'exposition chaude | 550 - 551 |
| Serie / Series / Série | | |
| HT | Carros calientes de distribución / Heated banquet trolleys / Chariot distributeur maintien au chaud | 552 - 553 |
| Serie / Series / Série | | |
| MICROONDAS HM | Horno microondas profesional Professional microwave oven / Four micro-ondes professionnel | 554 - 555 |
| Serie / Series / Série | | |
| FERMENTADOR | Armario caliente fermentador Fermentation ovens / Armoire de fermentation | 556 - 557 |
| HORNO ELÉCTRICO HE | Horno eléctrico para panadería Electric bakery oven / Fours pour la boulangerie | |

| | | | |
|------------------------|---|--|------------------|
| Serie / Series / Série | VACE | Envasadora al vacío de aspiración externa External aspiration vacuum packaging machine Machine sous vide à aspiration extérieure | 558 |
| Serie / Series / Série | TSB | Máquina termoselladora Thermosealer machine / Machines thermo-soudeuses | 559 |
| Serie / Series / Série | VACT | Envasadora al vacío por tiempo Time vacuum packaging machine / Machines sous vide pour temps | 560 |
| Serie / Series / Série | VACS | Envasadora al vacío por sensor Sensor vacuum packaging machine / Machines sous vide pour senseur | 561 |
| Serie / Series / Série | PG PG/PE | Plancha a gas - Plancha eléctrica Gas - Electrical griddles / Plancha à gaz - électrique | 562 - 563 |
| Serie / Series / Série | GR | Grill eléctrico Electrical grill / Grill panini électrique | 564 |
| Serie / Series / Série | FR | Freidora eléctrica Electrical fryer / Friteuse électrique | 565 |
| Serie / Series / Série | NEW SE / SEUF / SG | Salamandra / Salamander / Salamandre | 566-567 |
| Serie / Series / Série | TTV-TTH / T | Tostador de túnel eléctrico - Tostador eléctrico Electric tunnel toaster-Electric toaster / Toaster à tunnel électrique-Toaster électrique | 568 - 569 |
| Serie / Series / Série | TL | Termo de leche Milk urns / Termo de lait | 570 |
| Serie / Series / Série | CS CSCEV | Cortadora de fiambre Sharpening slicers / Trancheuse professionnelle | 571 |



Dispensador / Fabricador de hielo cubito macizo /
 Dispenser / Ice maker solid ice cube /
 Dispensateur / Machines à glaçons solides

Serie / Series / Série **FHC Ice Cube**

FHIKU26AHC

NEW



FHDSS42A/W

NEW



FHC20AHC/WHC



FHC80AHC/WHC



Serie C: cubito macizo con almacén
 C Series: solid ice cube with storage
 Séries C: bloc glaçon avec stockage

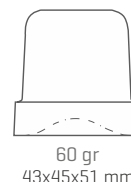
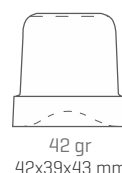
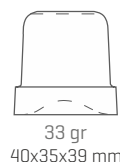

DISPENSADOR
 DISPENSER
 DISPENSEUR



FABRICADOR/ICEMAKER/MACHINE À GLAÇONS

| MODELO/MODELE/MODÈLE | FHIKU26AHC | FHDSS42A FHDSS42W | FHC20AHC FHC20WHC | FHC30AHC FHC30WHC | FHC35AHC FHC35WHC | FHC40AHC FHC40WHC | FHC45AHC FHC45WHC | FHC65AHC FHC65WHC | FHC80AHC FHC80WHC | FHC90AHC FHC90WHC |
|---|---|---|---|---|---|---|---|---|---|---|
| Precio Price Prix | 2.682 € | 3.110 € 3.157 € | 1.241 € 1.284 € | 1.444 € 1.509 € | 1.696 € 1.706 € | 1.763 € 1.838 € | 1.893 € 1.931 € | 2.519 € 2.561 € | 2.727 € 2.789 € | 2.875 € 2.973 € |
| Medidas Measures [mm] Mesures | ↔ 395 ↕ 530 ↕ 790 | ↔ 500 ↕ 630 ↕ 920 | ↔ 355 ↕ 404 ↕ 590 | ↔ 390 ↕ 460 ↕ 690 | ↔ 500 ↕ 580 ↕ 690 | ↔ 500 ↕ 580 ↕ 690 | ↔ 500 ↕ 580 ↕ 800 | ↔ 735 ↕ 603 ↕ 850 | ↔ 738 ↕ 600 ↕ 920 | ↔ 738 ↕ 600 ↕ 1020 |
| Tensión/Frecuencia Electrical data [V/Hz] Tension électrique | Medidas sin patas / Measurements without legs / Dimensions sans pieds Patas regulables / Adjustable legs / Pieds réglables [110-150mm] 220V-240V/50Hz | | | | | | | | | |
| Material Material Matériel | Termoconf. Thermof. Thermof. | AISI 304 | | | | | | | | |
| Condensación Condensation Condenseur | Aire Air Air | Aire / Agua Air / Water Air / Eau | Aire / Agua Air / Water Air / Eau | Aire / Agua Air / Water Air / Eau | Aire / Agua Air / Water Air / Eau | Aire / Agua Air / Water Air / Eau | Aire / Agua Air / Water Air / Eau | Aire / Agua Air / Water Air / Eau | Aire / Agua Air / Water Air / Eau | Aire / Agua Air / Water Air / Eau |
| Cubito Cubes Glaçons [gr] | 13 | 13 | 13 | 42 | 42 | 42 | 42 | 42 | 42 | 42 |
| Producción Production Compresseur [Kg/24h] | 24 | 44 | 21 | 29 | 38 | 42 | 48 | 72 | 80 | 95 |
| Almacén Warehouse Stockage [Kg.] | 7 | 12 | 4 | 9 | 16 | 16 | 25 | 40 | 40 | 55 |
| Potencia Power Puissance [W] | - | - | 260 | 320 | 340 | 340 | 450 | 590 | 700 | 890 |
| Refrigerante Refrigerant Gaz | R290 | HFC | R290 | | | | | | | |
| Opcional Optional Options | Gas refrigerante HFC / Refrigerant gas HFC / Gaz réfrigérant HFC (Mod. FHC 130 AHC, FHC 155 AHC) Cubito 60gr [consultar] / Cube 60gr [consult] / Glaçon 60gr [consultar] | | | | | | | | | |

Producción en condiciones óptimas: temperatura ambiente 21°C, temperatura agua 15°C.

Production in optimum conditions: room temperature 21°C, water temperature 15°C.

Production dans des conditions optimales: température ambiante 21°C, température de l'eau 15°C.

Fabricador de hielo cubito macizo /
Ice maker solid ice cube /
Machines à glaçons solides

Serie / Series / Série FHCM/SPLIT Ice Cube



Serie CM-Modular: cubito macizo sin almacén
CM-Modular Series: solid ice cube without storage
Série CM-Modulaire: glaçon entier sans stockage

Serie CM-Split: cubito macizo sin unidad condensadora
CM-Split Series: solid ice cube without condensed unit
Série CM-Split: glaçon entier sans unité de condensation

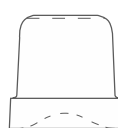

42 gr
42x39x43 mm

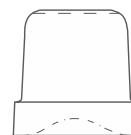

60 gr
43x45x51 mm

FABRICADOR/ICEMAKER/MACHINE À GLAÇONS

MODULAR

SPLIT

| MODELO/MODELE/MODÈLE | FHC130AHC | FHC155AHC | FHCM150AHC FHCM150W | FHCM300A FHCM300W | FHCM300S SPLIT |
|---|---|--------------------|---|---|---|
| Precio Price Prix | 3.742 € | 3.919 € | 3.706 € 3.794 € | 6.219 € 6.282 € | 4.469 € |
| Medidas Measures (mm) Mesures | 840 740 1075 | 840 740 1075 | 862 555 720 | 1250 580 848 | 990 585 850 |
| Tensión/Frecuencia Electrical data (V/Hz) Tension électrique | 220V-240V/50Hz | | | | |
| Material Material Matériel | AISI 304 | | | | |
| Condensación Condensation Condenseur | Aire Air Air | Aire Air Air | Aire / Agua Air / Water Air / Eau | Aire / Agua Air / Water Air / Eau | Sin unidad condensadora Without condensed unit Sans unité de condensation |
| Cubito Cubes Glaçons (gr) | 42 | 42 | 42 | 42 | 42 |
| Producción Production (Kg/24h) Compresseur | 134 | 152 | 155 | 300 | 300 |
| Depósito compatible Compatible deposit Dépôt compatible | 65 | 65 | DI200 / DPE240 / DI350 | DI350 | DI350 |
| Potencia Power Puissance (W) | 1250 | 1260 | 1260/1400 | 2600 | 200 |
| Refrigerante Refrigerant Gaz | R290 | | R290 / HFC | HFC | HFC |
| Opcional Optional Options | Gas refrigerante HFC / Refrigerant gas HFC / Gaz réfrigérant HFC | | [FHCM150] Gas refrigerante HFC / Refrigerant gas HFC / Gaz réfrigérant HFC Cubito 60gr [consultar] / Cube 60gr [consult] / Glaçon 60gr [consulter] | | |

Producción en condiciones óptimas: temperatura ambiente 21°C, temperatura agua 15°C.
Production in optimum conditions: room temperature 21°C, water temperature 15°C.
Production dans des conditions optimales: température ambiante 21°C, température de l'eau 15°C.

Los datos técnicos están sujetos a posibles variaciones que serán actualizadas periódicamente en las fichas técnicas del producto, disponibles en la web /
The technical data are subject to possible variations that will be updated periodically in the technical data sheets of the product, which are available on the website /
Les données techniques peuvent varier et seront actualisées dans les fiches techniques du produit, disponibles sur le site web.



Fabricador de hielo cubito cuadrado /
Ice maker solid square cube /
Machines à glaçons carré

Serie / Series / Série **FHC B-Qube**



FHC30BQAHC/WHC



FHC45BQAHC/WHC



FHC90BQAHC/WHC



Serie B-Qube: cubito macizo cuadrado
B-Qube Series: Solid square cube
Séries B-Qube: bloc glaçon carré

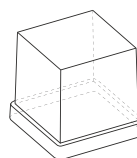

23 gr
32.5x31.5 mm

| MODELO/MODELE/MODÈLE | FHC30BQAHC FHC30BQWHC | FHC35BQAHC FHC35BQWHC | FHC40BQAHC FHC40BQWHC | FHC45BQAHC FHC45BQWHC | FHC65BQAHC FHC65BQWHC | FHC90BQAHC FHC90BQWHC |
|---|---|----------------------------------|----------------------------------|----------------------------------|----------------------------------|----------------------------------|
| Precio Price Prix | 1.623 € 1.665 € | 1.945 € 1.974 € | 1.996 € 2.042 € | 2.060 € 2.112 € | 2.652 € 2.695 € | 3.026 € 3.130 € |
| Medidas Measures [mm] Mesures | 390 460 690 | 497 592 687 | 497 592 687 | 500 580 800 | 738 600 920 | 738 600 1020 |
| | Medidas sin patas / Measurements without legs / Dimensions sans pieds Patas regulables / Adjustable legs / Pieds réglables (110-150mm) | | | | | |
| Tensión/Frecuencia Electrical data [V/Hz] Tension électrique | 220V-240V/50Hz | | | | | |
| Material Material Matériel | AISI 304 | | | | | |
| Condensación Condensation Condenseur | Aire / Agua Air / Water Air / Eau | | | | | |
| Cubito Cubes [gr] Glaçons | 23 | | | | | |
| Producción Production [Kg/24h] Compresseur | 29 | 38 | 42 | 48 | 72 | 90 |
| Almacén Warehouse [Kg.] Stockage | 9 | 16 | 16 | 25 | 40 | 55 |
| Potencia Power [W] Puissance | 320 | 340 | 455 | 450 | 620 | 890 |
| Refrigerante Refrigerant Gaz | R290 | | | | | |
| Opcional Optional Options | - | | | | | |

Producción en condiciones óptimas: temperatura ambiente 21°C, temperatura agua 15°C.

Production in optimum conditions: room temperature 21°C, water temperature 15°C.

Production dans des conditions optimales: température ambiante 21°C, température de l'eau 15°C.

Fabricador de hielo hueco /
Hollow ice maker /
Machines à glaçons creux

Serie / Series / Série IMF



IMF28AHC/IMF28WHC



IMF35AHC/IMF35WHC



IMF58AHC/IMF58WHC



Serie IMF: cubito hueco
IMF Series: hollow cube
Séries IMF: glaçon creux



20 gr
29 Ø x 45 mm 12 Ø x 36,5 mm

| MODELO/MODELE/MODÈLE | IMF26AHC IMF26WHC | IMF28AHC IMF28WHC | IMF35AHC IMF35WHC | IMF58AHC IMF58WHC | IMF80AHC IMF80WHC |
|---|---|----------------------|----------------------|----------------------|----------------------|
| Precio Price Prix | Sólo para Francia / France only / Seulement pour la France | | | | |
| Medidas Measures Mesures (mm) | 385 468 607 | 385 468 687 | 495 580 687 | 495 580 797 | 735 596 907 |
| Tensión/Frecuencia Electrical data Tension électrique [V/Hz] | 220V-240V/50Hz | | | | |
| Material Material Matériel | AISI 304 | | | | |
| Condensación Condensation Condenseur | Aire / Agua Air / Water Air / Eau | | | | |
| Cubito Cubes Glaçons (gr) | 20 | | | | |
| Producción Production Compresseur (Kg/24h) | 22 | 22 | 38 | 46 | 85 |
| Almacén Warehouse Stockage (Kg.) | 4 | 8 | 15 | 20 | 30 |
| Potencia Power Puissance (W) | 300 | 300 | 275 | 315 | 500 |
| Refrigerante Refrigerant Gaz | R290 | | | | |
| Opcional Optional Options | Gas refrigerante HFC / Refrigerant gas HFC / Gaz réfrigérant HFC | | | | |

Producción en condiciones óptimas: temperatura ambiente 21°C, temperatura agua 15°C.
Production in optimum conditions: room temperature 21°C, water temperature 15°C.
Production dans des conditions optimales: température ambiante 21°C, température de l'eau 15°C.

Los datos técnicos están sujetos a posibles variaciones que serán actualizadas periódicamente en las fichas técnicas del producto, disponibles en la web /
The technical data are subject to possible variations that will be updated periodically in the technical data sheets of the product, which are available on the website /
Les données techniques peuvent varier et seront actualisées dans les fiches techniques du produit, disponibles sur le site web.



Fabricador de hielo troceado Pebbles (coctelería) /
Pebbles ice maker /
Machines à ice en morceau



FHTB90AHC/WHC



FHTB57AHC/WHC



HIELO TROCEADO PEBBLES / PEBBLES ICE / GLACE EN MORCEAU PEBBLES

Serie TB: hielo troceado con almacén

TB Series: pebbles ice with storage

Séries TB: ice en morceau avec storage

Serie TBM-Modular: hielo troceado sin almacén

TBM-Modular Series: pebbles ice without storage

Série TBM-Modular: Ice en morceau sans storage

| MODELO/MODELE/MODÈLE | FHTB57AHC FHTB57WHC | FHTB90AHC FHTB90WHC | FHTB93AHC FHTB93WHC | FHTB142AHC FHTB142WHC | FHTB146AHC FHTB146WHC | FHTBM140AHC FHTBM140WHC | FHTBM250AHC FHTBM250WHC | FHTBM450AHC FHTBM450WHC | |
|---|---|----------------------------------|----------------------------------|----------------------------------|----------------------------------|----------------------------------|--|---|--|
| Precio Price Prix | 3.199€ 3.215€ | 3.250 € 3.316 € | 3.325 € 3.359 € | 3.772 € 3.811 € | 3.840 € 3.879 € | 3.932 € 3.996 € | 5.474 € 5.859 € | 6.336 € 6.734 € | |
| Medidas Measures Mesures (mm) | 450 620 680 | 500 660 690 | 500 660 800 | 738 690 851,5 | 738 690 1020 | 560 569 600 | 560 569 600 | 560 569 600 | |
| | Medidas sin patas / Measurements without legs / Dimensions sans pieds Patatas regulables / Adjustable legs / Pieds réglables (110-150mm) | | | | | | | | |
| Tensión/Frecuencia Electrical data [V/Hz] Tension électrique | 220V-240V/50Hz | | | | | | | | |
| Material Material Matériel | AISI 304 | | | | | | | | |
| Condensación Condensation Condenseur | Aire / Agua Air / Water Air / Eau | | | | | | | | |
| Producción Production [Kg/24h] Compresseur | 57 | 90 | 90 | 142 | 146 | 130 | 245 | 375 | |
| Almacén Warehouse [Kg.] Stockage | 10 | 20 | 30 | 40 | 50 | - | | | |
| Depósito compatible Compatible deposit Dépôt compatible | - | | | | | DPE240/ DI110 DI200/RB100 | DPE240/DI110/ DI200/ DI350/ DI350/RB100 DRB100 | DPE240/DI110/DI200/ DI350/DI550/RB100/ DRB100/DRB1500/ DRB1200 | |
| Potencia Power [W] Puissance | 410 | 440 | 440 | 720 | 720 | 700 | 1050 | 1415 | |
| Refrigerante Refrigerant Gaz | R290 | | | | | | | | |
| Opcional Optional Options | Gas refrigerante HFC / Refrigerant gas HFC / Gaz réfrigérant HFC | | | | | | | | |

Serie / Series / Série **FHTB / FHTBM PEBBLES**

+Info: www.infrico.com



FHTB142AHC/WHC



FHTB146AHC/WHC



FHTBM450AHC/TM450AHC



Fabricador de hielo troceado /
Cubed ice maker /
Machines à glace en morceau

Serie / Series / Série FHT / FHTM Ice Flakes



FHT155AHC/WHC

Serie T: hielo troceado con almacén
 T Series: cubed ice with storage
 Séries T: glace en morceau avec stockage



FHTM160AHC/WHC
FHTM280AHC/WHC
FHTM510AHC/WHC



FHTM1000A/W

Serie TM-Modular: hielo troceado sin almacén
 TM-Modular Series: cubed ice without storage
 Série TM-Modular: glace en morceau sans stockage



HIELO TROCEADO / CUBED ICE / GLACE EN MORCEAU

| MODELO/MODELE/MODÈLE | FHT60AHC FHT60WHC | FHT90AHC FHT90WHC | FHT155AHC FHT155WHC | FHTM160AHC FHTM160WHC | FHTM280AHC FHTM280WHC | FHTM510AHC FHTM510WHC | FHTM1000A/W |
|---|--|----------------------------------|----------------------------------|---|--|--|------------------------------------|
| Precio Price Prix | 3.174 € 3.205 € | 3.483 € 3.633 € | 4.040 € 4.088 € | 3.826 € 3.894 € | 5.316 € 5.351 € | 6.402 € 6.741 € | 13.692 € 13.742 € |
| Medidas Measures [mm] Mesures | 450 620 680 | 500 660 800 | 738 690 1020 | 560 569 600 | 560 569 695 | 560 569 695 | 934 684 700 |
| | - | | | Medidas sin patas / Measurements without legs / Dimensions sans pieds Patatas regulables / Adjustable legs / Pieds réglables (110-150mm) | | - | |
| Tensión/Frecuencia Electrical data [V/Hz] Tension électrique | 220V-240V/50Hz | | | | | | 400-415V/3N/50Hz |
| Material Material Matériel | AISI 304 | | | | | | |
| Condensación Condensation Condenseur | Aire / Agua Air / Water Air / Eau | | | | | | |
| Producción Production [Kg/24h] Compresseur | 67 | 113 | 153 | 157 | 280 | 435 | 1000 |
| Almacén Warehouse [Kg.] Stockage | 9 | 30 | 55 | - | | | |
| Depósito compatible Compatible deposit Dépôt compatible | - | | | DPE240/ DI110 DI200/RBI100 | DPE240/DI110/ DI200/ DI350/ DI550/RBI100 DRBI100 | DPE240/DI110/ DI200/ DI350/ DI550/RBI100 DRBI100/DRBI500 | DI550/ DRBI500 |
| Potencia Power [W] Puissance | 400 | 470 | 700 | 830 | 1100 | 1400 | 3200 |
| Refrigerante Refrigerant Gaz | R290 | | | | | | HFC |
| Opcional Optional Options | Gas refrigerante HFC / Refrigerant gas HFC / Gaz réfrigérant HFC | | | | | | |

Producción en condiciones óptimas: temperatura ambiente 21°C, temperatura agua 15°C.

Production in optimum conditions: room temperature 21°C, water temperature 15°C.

Production dans des conditions optimales: température ambiante 21°C, température de l'eau 15°C.

Fabricador de hielo troceado /
Cubed ice maker /
Machines à glace en morceau

Serie / Series / Série FHTM/SPLIT Ice Flakes



HIELO TROCEADO
CUBED ICE
GLACE EN MORCEAU



FHTM1000S SPLIT

Serie SPLIT: hielo troceado sin unidad condensadora
SPLIT Series: ice divided without condensed unit
Séries SPLIT: glace en morceaux sans unité de condensation

| MODELO/MODELE/MODÈLE | FHTM510S SPLIT | FHTM1000S SPLIT |
|--|--|------------------------|
| Precio Price Prix | 5.256 € | 10.059 € |
| Medidas Measures [mm] Mesures | 560 569 695 | 765 600 695 |
| Tensión/Frecuencia Electrical data [V/Hz] Tension électrique | 220V-240V/50Hz | |
| Material Material Matériel | AISI 304 | |
| Condensación Condensation Condenseur | Sin unidad condensadora Without condensed unit Sans unité de condensation | |
| Producción Production [Kg/24h] Compresseur | 510 | 1000 |
| Depósito compatible Compatible deposit Dépôt compatible | DPE240 / DI200 / DI350 / DI550 RBI100 / DRBI100 / DRBI500 | DI550 / DRBI500 |
| Potencia Power [W] Puissance | 175 | 350 |
| Potencia frigorífica Refrigerating Power [W -18°C] Puissance frigorifique | 2300 [evap.temp.-18°C] | 4600 [evap.temp.-18°C] |
| Refrigerante Refrigerant Gaz | HFC | |
| Opcional Optional Options |  Modelos Split para gas refrigerante R744 [CO2] (FHT700SC02 (720 kg), FHTM1400SC02 (1400 kg) Split models for refrigerant R744 [CO2] (FHT700SC02 (720kg), FHTM1400SC02 (1400kg) Modèles split pour gaz R744 [CO2] (FHT700SC02 (720kg), FHTM1400SC02 (1400kg) | |

Producción en condiciones óptimas: temperatura ambiente 21°C, temperatura agua 15°C.
Production in optimum conditions: room temperature 21°C, water temperature 15°C.
Production dans des conditions optimales: température ambiante 21°C, température de l'eau 15°C.



Fabricador de hielo escama plana /
Ice maker flat flakes /
Machines à ice à pailletes

Serie / Series / Série **FHES Cold Flakes**



FHESM400A/W



FHESM2200A



FHESM 5000A

Serie ES-Modular: hielo en escama plana sin almacén
ES-Modular Series: Flat flake ice without storage
Séries ES-Modular: ice à pailletes sans storage



HIELO EN ESCAMA
FLAKE ICE
GLACE À PAILLETES

| MODELO/MODELE/MODÈLE | FHESM250A FHESM250W | FHESM400A FHESM400W | FHESM600A FHESM600W | FHESM900A FHESM900W | FHESM1500A FHESM1500W | FHESM2200A - | FHESM5000A - |
|---|---|---------------------------|-----------------------------------|------------------------|--------------------------|---------------------|----------------------|
| Precio Price Prix | 8.245 € | 9.589 € | 11.432 € | 15.328 € | 23.376 € | 30.716 € | 59.257 € |
| Medidas Measures [mm] Mesures | 870 550 600 | 900 588 705 | 900 588 705 | 1107 700 880 | 1107 700 970 | 1062 832 1423 | 1270 1400 1620 |
| Tensión/Frecuencia Electrical data [V/Hz] Tension électrique | 220V-240V/50Hz | | | 400V-415V//3N/50Hz | | | |
| Material Material Matériel | AISI 304 | | | | | | |
| Condensación Condensation Condenseur | Aire / Agua Air / Water Air / Eau | | | | | Aire Air Air | |
| Producción Production [Kg/24h] Compresseur | 250 | 400 | 620 | 900 | 1500 | 2300 | 5000 |
| Almacén Warehouse Stockage | - | | | | | | |
| Depósito compatible Compatible deposit Dépôt compatible | D1200 D1350 | D1350 D1550 DRBI100 | D1350 D1550 DRBI100/DRBI500 | D1550 DRBI500 | D1550 DRBI500 | - | |
| Potencia Power Puissance [W] | 1700 | 2100 | 3000 | 4600 | 6000 | 7000 | 16000 |
| Refrigerante Refrigerant Gaz | HFC | | | | | | |
| Opcional Optional Options | - | | | | | | |

Producción en condiciones óptimas: temperatura ambiente 21°C, temperatura agua 15°C.

Production in optimum conditions: room temperature 21°C, water temperature 15°C.

Production dans des conditions optimales: température ambiante 21°C, température de l'eau 15°C.

Fabricador de hielo escama plana /
Ice maker flat flakes /
Machines à ice à pailletes

Serie / Series / Série FHESM/SPLIT Cold Flakes



FHESM5000S SPLIT



FHESM400S a 2200S SPLIT

Serie ES-SPLIT: hielo en escama plana sin unidad condensadora
ES-SPLIT Series: Flat flake ice without condensed unit
Séries ES-SPLIT: ice à pailletes sans unité de condensation



HIELO EN ESCAMA
FLAKE ICE
GLACE À PAILLETES

MODELO/MODELE/MODÈLE FHESM400S SPLIT FHESM600S SPLIT FHESM900S SPLIT FHESM1500S SPLIT FHESM2200S SPLIT FHESM5000S SPLIT

| MODELO/MODELE/MODÈLE | FHESM400S SPLIT | FHESM600S SPLIT | FHESM900S SPLIT | FHESM1500S SPLIT | FHESM2200S SPLIT | FHESM5000S SPLIT |
|--|--|------------------------------------|-----------------------------|-----------------------------|------------------------------|------------------------------|
| Precio Price Prix | 7.314 € | 7.988 € | 10.628 € | 15.353 € | 23.095 € | 44.842 € |
| Medidas Measures [mm] Mesures | 495 588 705 | 495 588 705 | 604 700 880 | 604 700 970 | 736 832 1075 | 1270 1015 1076 |
| Tensión/Frecuencia Electrical data [V/Hz] Tension électrique | 220V-240V/50Hz | | | | 400V-415V//3N/50Hz | |
| Material Material Matériel | AISI 304 | | | | | |
| Condensación Condensation Condenseur | Sin unidad condensadora Without condensed unit Sans unité de condensation | | | | | |
| Producción Production [Kg/24h] Compresseur | 400 | 620 | 900 | 1500 | 2300 | 5000 |
| Depósito compatible Compatible deposit Dépôt compatible | DI350 / DI550 DRBI100 | DI350 / DI550 DRBI100 / DRBI500 | DI550 / DRBI500 | DI550 / DRBI500 | - | - |
| Potencia Power [W] Puissance | 180 | | | | | 360 |
| Potencia frigorífica Refrigerating Power [W -18°C] Puissance frigorifique | 2200W [evap.temp. -23°C] | 3500W [evap.temp. -22°C] | 5000W [evap.temp. -23°C] | 8550W [evap.temp. -24°C] | 12000W [evap.temp. -27°C] | 25000W [evap.temp. -27°C] |
| Refrigerante Refrigerant Gaz | HFC | | | | | |
| Opcional Optional Options |  Modelos Split para gas refrigerante R744 [CO2] (FHESM600SC02 [620 kg], FHESM900SC02 [1040kg], FHESM1500SC02 [1520kg]). Split models for refrigerant R744 [CO2] (FHESM600SC02 [620 kg], FHESM900SC02 [1040kg], FHESM1500SC02 [1520kg]). Modèles split pour gaz R744 [CO2] (FHESM600SC02 [620 kg], FHESM900SC02 [1040kg], FHESM1500SC02 [1520kg]). | | | | | |

Producción en condiciones óptimas: temperatura ambiente 21°C, temperatura agua 15°C.
Production in optimum conditions: room temperature 21°C, water temperature 15°C.
Production dans des conditions optimales: température ambiante 21°C, température de l'eau 15°C.

Los datos técnicos están sujetos a posibles variaciones que serán actualizadas periódicamente en las fichas técnicas del producto, disponibles en la web /
The technical data are subject to possible variations that will be updated periodically in the technical data sheets of the product, which are available on the website /
Les données techniques peuvent varier et seront actualisées dans les fiches techniques du produit, disponibles sur le site web.



Almacén fabricante de hielo /
Ice maker storage /
Stockage pour machine à glaçons

Serie / Series / Série **DPE/DI**



DPE240

DI200

DI350

DI550



DPE240

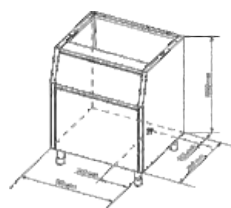

DI200

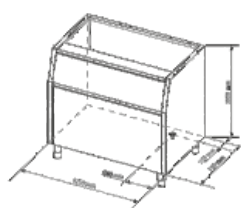

DI350

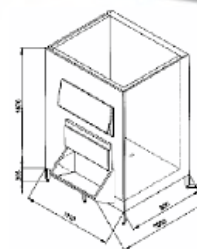

DI550

| MODELO/MODELE/MODÈLE | DPE240 | DI110 | DI200 | DI350 | DI550 |
|--|---|--|---|--|--|
| Precio Price Prix | 1.611 € | 1.566 € | 1.811 € | 2.626 € | 8.751 € |
| Medidas Measures (mm) Mesures | 942 795 1053 | 560 815 1000 | 870 790 1000 | 1250 790 1000 | 1110 1060 1915 |
| | Medidas sin patas / Measurements without legs / Dimensions sans pieds Patas regulables / Adjustable legs / Pieds réglables (110-160mm) | | | | |
| Material Material Matériel | Depósito: polietileno / Storage: polyethylene / Stockage: polyéthylène | | Depósito / Storage / Stockage: AISI 304 | | |
| Almacén Warehouse Stockage (Kg.) | - | | | | |
| Reserva Reserve Réserve | 180 | 100 | 200 | 350 | 550 |
| Fabricador Manufacturer Machine à glaçons | CM150 / TM160 TM280 / TM510 TM510 SPLIT FHTBM140 / FHTBM250 FHTBM450 | TM160 / TM280 TM510 / TM510 SPLIT FHTBM140 FHTBM250 FHTBM450 | CM150 / TM160 TM280 / TM510 TM510 SPLIT / ESM250 FHTBM140 / FHTBM250 FHTBM450 | CM150 / CM300 / CM300 SPLIT TM280 / TM510 / TM510 SPLIT ESM250 / ESM400 ESM600 FHTBM250 / FHTBM450 | TM510 (2) / TM510 (2) SPLIT TM1000 / TM1000 SPLIT ESM400 / ESM600 / ESM900 ESM1500 / ESM1500 SPLIT FHTBM250 / FHTBM450 |
| Opcional Optional Options | - | | | | |

Almacén de hielo /
Ice storage /
Stockage pour glaçons

Serie / Series / Série ROLLER BIN
DOBLE ROLLER BIN



| MODELO/MODELE/MODÈLE | RBI100 | DRBI100 | DRBI500 | DRBI1200 |
|--|---|--|---|--|
| Precio Price Prix | 4.421 € | 6.920 € | 12.367 € | 15.291 € |
| Medidas Measures Mesures (mm) | 795 1060 1284 | 1560 1060 1484 | 1560 1330 1810 | 1560 1330 2460 |
| Material Material Matériel | Depósito / Storage / Stockage: AISI 304 Contenedor polietileno / Container in polyethylene / Container en polyéthylène | | | |
| Almacén Warehouse Stockage (Kg.) | 17 | 50 | 300 | 1000 |
| Reserva Reserve Réserve | 108 | 108+108 | 108+108 | 108+108 |
| Fabricador Manufacturer Machine à glaçons | FHTM160 FHTM280 FHTM510 / FHTM510 SPLIT FHTBM250 / FHTBM450 | FHTM280 / FHTM510 FHESM400 / FHESM600 FHESM400 SPLIT / FHESM600 SPLIT FHTBM140 / FHTBM250 FHTBM450 | FHTM510 (2) / FHTM510 SPLIT (2) FHTM1000 / FHTM1000 SPLIT FHESM600 / FHESM600 SPLIT FHESM900 / FHESM900 SPLIT FHESM1500 / FHESM1500 SPLIT FHTBM450 | FHTM510 (2) / FHTM510 SPLIT (2) FHTBM450 FHESM600 / FHESM600 SPLIT FHESM900 SPLIT |
| Opcional Optional Options | | | | |



Lavavasos y lavaplatos / Glasswasher, dishwasher and hood dishwasher / Lave-vaisselle

A DESTACAR

Estructura interior y exterior en acero inoxidable.

Puerta construida en doble pared.

Guías cesta embutidas, modelos LVP2535, LVP3040 y LVP3250.

Brazos de lavado inferior en acero inoxidable y superior en composite.

Cuba con fondo embutido, dotado con filtro en toda la anchura de la cuba.

Modelo LVP3040 con lavado superior giratorio.

Brazos de aclarado en composite.

Bombas de lavado con sistema DuoFlo excepto en el modelo LV2535, sistema de bomba con una entrada y dos salidas, de esta forma se elimina la pérdida de potencia y el ruido disminuye, mejora el rendimiento y disminuye el consumo de energía, excepto en el modelo LV2535.

Dosificador de abrillantador peristáltico con regulación electrónica al igual que el dosificador detergente [opcional].

Modelos con Bomba desagüe [BD] con descarga parcial, durante el aclarado se introduce agua limpia en la cuba para sustituir la sucia, se realizan aportaciones continuas de agua limpia, cuando termina el ciclo de lavado parte del agua de la cuba ha sido renovada.

Garantizamos un caudal en litros constantes en el aclarado independientemente de la presión del agua de red.

Mesas de entrada y salida, mesa prelavado, etc.

BENEFITS

Interior and exterior structure in stainless steel.

Door made of double wall.

Embossed rack's drives, models LVP2535, LVP3040 y LVP3250.

Lower wash arms in stainless steel and upper composite.

Welded tank, equipped with filter for the entire width of the tank.

Model LVP3040 with rotatory top wash.

Composite rinse arms.

Wash pumps with the DuoFlo system except the model LV2535, pump system with one inlet and two outlets, this eliminates energy loss and noise decreases, improves performance and reduces energy consumption except in the model LV2535.

Dosing of peristaltic rinse aid with electronic regulation as well as dosage detergent [optional].

Models with drain pump [BD] with the partial discharge, during the rinse introduce the clean water in the tank to replace the dirty, continuous contributions of clean water are made, when the washing cycle is finished part of the water of the tank has been renewed.

We guarantee a flow in constant liters in the rinsing regardless of the water pressure of network.

Tables of entrance and exit, prewash table, etc.

À SOULIGNER

Structure intérieure et extérieure en acier inoxydable.

Porte construite en double paroi. Bras de lavage inférieurs en acier inoxydable et composite supérieur.

Modèle LVP3040 avec lavage supérieur.

Bras de rinçage composite.

Nouvelle carte électronique commune pour toute la gamme, avec connexion USB pour sa mise à jour et sa programmation.

Sur l'écran il est possible d'afficher la température de lavage et de rinçage, ainsi que codes d'erreur.

ProSelf programme d'auto-nettoyage à effectuer à la fin de la journée.

Possibilité de régler les feeders de produits à travers la plaque chimique.

Pompes de lavage avec système DuoFlo sauf pour le modèle LV2535, système pompe avec une entrée et deux sorties, ainsi on évite la perte de puissance et le bruit diminue, améliore la performance et diminue la consommation d'énergie, sauf dans le modèle LV2535.

Dosage du liquide de rinçage électroniquement comme le dosage du produit de lavage [option].

Modèles avec pompe de vidange [BD] à décharge partielle, pendant le rinçage de l'eau propre est introduite dans le réservoir pour remplacer l'eau sale, distribution en continu d'eau propre, à la fin du cycle de lavage une partie de l'eau dans le réservoir a été renouvelée.

Nous garantissons un débit en litres constante pendant le rinçage indépendamment de la pression de l'eau du réseau.



Serie / Series / Série **ELECTROMECÁNICA**
ELECTROMECHANICAL
ÉLECTROMÉCANIQUE

+Info: www.infrico.com



LCP4550



Lavavasos y lavaplatos /
 Glasswasher, dishwasher and hood dishwasher /
 Lave-vaisselle



LVP3040

LVP3250



Serie / Series / Série **ELECTROMECAÁNICA**
ELECTROMECHANICAL
ÉLECTROMÉCANIQUE

+Info: www.infrico.com



Brazo lavado y aclarado superior modelo LVP3250
Upper washing and rising arm model LVP3250
Bras supérieur de lavage et de rinçage, modèle LVP3250



Bomba de lavado DuFlo
Washing pump DuFlo
Pompe de lavage DuFlo

| MODELO/MODELE/MODÈLE | LV2535 LV2535 BD | LVP3040 LVP3040 BD | LVP2845 LVP2845 BD | LVP3250 LVP3250 BD LVP3250 DBD | LCP4550 LCP4550 BD LCP4550 DBD |
|---|--|---|---|---|---|
| Precio Price Prix | 1.259 € 1.351 € | 1.545 € 1.638 € | 1.935 € 2.024 € | 2.125 € 2.251 € 2.354 € | 3.703 € 3.765 € 3.863 € |
| Medidas Measures [mm] Mesures | 401x490x595 | 436x535x670 | 525x555x715 | 575x605x820 | 724x818x1529 [2010] |
| Medidas de cesta Rack measures [mm] Mesures de panier | 350x350 | 400x400 | 450x450 | 500x500 | 500x500 |
| Altura útil de lavado Washing height [mm] Hauteur utile de lavage | 250 | 300 | 280 | 325 | 425/440 |
| Ciclos de lavado estándar Standard washing cycles Durée du cycle | 120 | 120 | 120 | 90/150 | 90/150 |
| Producción horaria Hourly production Production horaire | 30 | 30 | 30 | 40/24 | 40/24 |
| Tensión/Frecuencia Electrical data [V/Hz] Tension électrique | 230/50/1N | 230/50/1N | 230/50/1N | 230/50/1N | 400/50/3N |
| Material Material Matériel | AISI 304 | | | | |
| Potencia Máx. funcionam. Max. operating power [W] Puissance maximale | 3500 | | | | 8500 |
| Pot. resistencia cuba Power tank resist. [W] Puiss. résist. cuvette | 600 | | | 2100 | |
| Pot. resist. boiler Boiler resist. power [W] Puiss. résist. boiler | 2600 | | | 3000 | 8000 |
| Pot. bomba lavado Whash. pump power [W] Puiss. bombe lavé | 150 | 200 | | 470 | |
| Temp. Lavado/Aclar. Wash/rinse temp. [°C] Temp. lavage/rinçage | 60°C/80°C | | | | |
| Capacidad cuba/boiler Tank/boiler capacity [L] Capacité cuvette | 7/2,6 | 9/2,6 | 14/2,6 | 20/6 | 15/6 |
| Consumo agua x cesta Water/rack consumpt. [L] Consomat. eau x panier | 1,8 | | | 2,2 | |
| Dotación Endowment Dotation | 2 Cestos vasos, 1 contenedor cubiertos, 1 insertador platos 2 glass racks, 1 storage cutlery, 1 plate inserter 2 paniers à verre, 1 bac couverts, 1 range assiettes | 2 Cestos, 1 contenedor cubiertos, 1 insertador platos 2 Racks, 1 storage cutlery, 1 plats inserter 2 paniers, 1 bac couverts, 1 range assiettes | 1 Cesto vasos/1 platos, 1 contenedor cubiertos, 1 insertador platos 1 Glass rack/1 plats, 1 storage cutlery, 1 plats inserter 1 panier à verre/1 assiettes, 1 bac couverts, 1 range assiettes | 1 Cesto vasos, 1 cesto platos, 1 contenedor cubiertos 1 Glass rack, 1 rack plats, 1 storage cutlery 1 panier à verre, 1 range assiettes, 1 bac couverts | |
| Opcional Optional Options | Kit dosificador detergente / Detergent dispenser kit / Kit doseur détergent 247 € Kit bomba desagüe sin descarga parcial / Drainage pump kit without partial discharge / Kit pompe de vidange sans décharge partielle 203 € | | | | |
| | - | 230V/1N/60Hz + 3% | - | 230V/1N/60Hz + 3% | 400V/3N/60Hz + 3% |
| | - | - | - | - | Recuperador de calor LCP4550 DBD RC +3.267 € |



Lavavasos y lavaplatos / Glasswasher, dishwasher and hood dishwasher / Lave-vaisselle

A DESTACAR

Estructura interior y exterior en acero inoxidable.

Puerta construida en doble pared.

Guía cesta estampada y embutida, modelos LVP3040E y LVP3250E.

Cuba con fondo embutido, dotado con filtro en toda la anchura de la cuba.

Brazos de lavado inferior en acero inoxidable y superior en composite, excepto en la gama de lavaplatos Cúpula que ambos son en acero inox.

Modelo LVP3040E con lavado superior giratorio.

Brazos de aclarado en composite.

Bombas de lavado con sistema DuoFlo, sistema de bomba con una entrada y dos salidas, de esta forma se elimina la pérdida de potencia y el ruido disminuye, mejora el rendimiento y disminuye el consumo de energía.

Todos los modelos con dosificador de detergente de serie.

Dosificador de abrillantador peristáltico con regulación electrónica.

Modelos con Bomba desagüe [BD] con descarga parcial.

Nueva placa de electrónica común para toda la gama, con conexión USB para su actualización y programación.

En el Display posibilidad de visionar temperatura de lavado y aclarado, códigos de errores, así como programas y fases del programa.

Cinco programas de lavado, con posibilidad de modificar tiempos.

Tres programas de tiempos 60, 120 y 150 segundos, lavado continuo y programa de auto limpieza ProSelf a realizar al final de la jornada.

Descarga automática en los modelos con bomba desagüe [BD] con descarga parcial.

Posibilidad de regular a través de la placa los dosificadores de producto químico.

Modelos con recuperador de calor, incluye bomba de Aclarado y bomba Descarga Parcial [BD]

BENEFITS

Embossed rack's drives, models LVP3040E y LVP3250E.

Welded tank, equipped with filter for the entire width of the tank. Interior and exterior structure in stainless steel.

Door made of double wall.

Lower wash arms in stainless steel and upper in composite, except in the range of dishwasher Dome that both are in stainless steel.

Model LVP3040E with rotatory top wash. Composite rinse arms.

Wash pumps with DuoFlo system, pump system with one inlet and two outlets, this eliminates loss of power and noise decreases, improves performance and decreases energy consumption.

All models with dosage detergent as standard.

Dosing of peristaltic rinse aid with electronic regulation.

Models with drain pump [BD] with partial discharge.

New common electronics board for the whole range, with USB connection for updating and programming.

In the Display it is possible to view wash and rinse temperature, error codes as well as programs and program phases.

Five washing programs, with the possibility of changing times.

Three 60, 120 and 150 second time programs, continuous washing and ProSelf self cleaning program to be performed at the end of the day and automatic discharge in the models with partial discharge drain [BD].

Possibility of regulating through the plate the chemical dosificadores.

Models with heat recovery, including Rinse pump and Partial Discharge pump [BD].

À SOULIGNER

Structure intérieure et extérieure en acier inoxydable.

Porte construite en double paroi.

Bras de lavage inférieurs en acier inoxydable et composite supérieur.

Modèle LVP3040 avec lavage supérieur.

Bras de rinçage composite.

Nouvelle carte électronique commune pour toute la gamme, avec connexion USB pour sa mise à jour et sa programmation.

Sur l'écran il est possible d'afficher la température de lavage et de rinçage, ainsi que les codes d'erreur.

ProSelf programme d'auto-nettoyage à effectuer à la fin de la journée.

Possibilité de réguler les doses de produit chimique.

Sur l'écran il est possible d'afficher la température de lavage et de rinçage, ainsi que codes d'erreur.

ProSelf programme d'auto-nettoyage à effectuer à la fin de la journée.

Possibilité de régler les feeders de produits à travers le contrôle électronique.

Pompes de lavage avec système DuoFlo sauf pour le modèle LV2535, système pompe avec une entrée et deux sorties, ainsi on évite la perte de puissance et le bruit diminue, améliore la performance et diminue la consommation d'énergie, sauf dans le modèle LV2535.

Tous les modèles avec dosage du produit de lavage à série.

Dosage du liquide de rinçage électroniquement.

Modèles avec pompe de vidange [BD] à décharge partielle, pendant le rinçage de l'eau propre est introduite dans le réservoir pour remplacer l'eau sale, distribution en continu d'eau propre, à la fin du cycle de lavage une partie de l'eau dans le réservoir a été renouvelée.

Nous garantissons un débit en litres constant pendant le rinçage indépendamment de la pression de l'eau du réseau.

Modèles avec récupération de chaleur, y incluant la pompe de rinçage et la pompe à décharge partielle [BD].

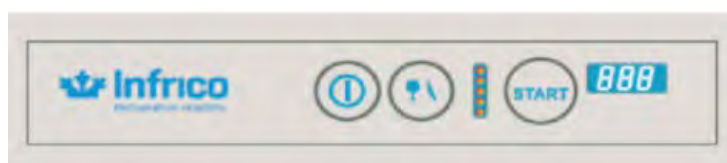

Serie / Series / Série **ELECTRÓNICA**
ELECTRONIC
ÉLECTRONIQUE

+Info: www.infrico.com

LCP4550ED



Lavavasos y lavaplatos / Glasswasher, dishwasher and hood dishwasher / Lave-vaisselle



Modelo LCP4550EDBDRRC con Recuperador de Calor RC

Aspira el vapor que se forma después del aclarado y lo condensa, el calor recuperado aumenta en 25°C la temperatura del agua que entra. Se obtiene un importante ahorro de energía gracias a la reducción en casi un 40%, de la variación térmica que el boiler debe proporcionar al agua del aclarado. Se produce al final el ciclo y elimina la descarga de vapor al abrir la capota.

Model LCP4550EDBDRRC with RC Heat Recovery

Aspirates the vapor that forms after the rinsing and condenses it, the recovered heat increases in 25°C the incoming water temperature. Significant energy savings are achieved thanks to a 40% reduction in the thermal variation that the boiler must provide to rinse water. It produces the cycle at the end and eliminates the discharge of steam when opening the canopy.

Modèle LCP4550EDBDRRC avec Récupération de chaleur RC

Aspire la vapeur qui se forme suite au rinçage et la condense, la chaleur récupérée augmente de 25°C la température de l'eau entrante. On obtient une importante économie d'énergie grâce à la réduction (presque de 40%) de la variation thermique que le boiler doit proportionner à l'eau de rinçage.



LVP3250ED



Serie / Series / Série **ELECTRÓNICA**
ELECTRONIC
ÉLECTRONIQUE

+Info: www.infrico.com



Capacidad bandejas
600x400 o GN 1/1
Capacity trays
600x400 or GN 1/1
Capacité plateaux
600x400 ou GN 1/1



Cuba embutida LCP 4550E
Stamped pan LCP 4550E
Cuve emboutie LCP 4550E



Cuba LCP 4560E
Pan LCP4560E
Cuve LCP 4560E

Nomenclatura / Nomenclature / Nomenclature:

E: Gama electrónica / Electronic range / Gamme électronique

D: Dosificador detergente de serie / Detergent dosing standard / Doseur détergent de série







BD: Bomba desagüe parcial de serie / Partial discharge pump standard / Pompe à vidange partielle de série

RC: Recuperador de calor / Heat recovery system / Récupération de chaleur

| MODELO/MODELE/MODÈLE | LVP3040ED LVP3040EDBD | LVP3250ED LVP3250EDBD | LCP4550ED LCP4550EDBD | LCP4560ED LCP4560EDBD | LCP4550EDBDRC |
|---|--|--|---|---|-------------------|
| Precio Price Prix | 1.703 € 1.794 € | 2.375 € 2.502 € | 4.106 € 4.233 € | 5.021 € 5.147 € | 7.078 € |
| Medidas Measures [mm] Mesures | 436x535x670 | 575x605x820 | 724x818x1529 [2010] | 788x835x1565 [2080] | 724x818x2229 |
| Medidas de cesta Rack measures [mm] Mesures de panier | 400x400 | 500x500 | 500x500 | 600x500 | 500x500 |
| Altura útil de lavado Washing height [mm] Hauteur utile de lavage | 300 | 325 | 425 / 440 | 440 | 425 / 440 |
| Ciclos de lavado estándar Standard washing cycles Durée du cycle | 60/120/150 Autolimpieza/Self-cleaning/ Autonettoyant | 60/120/150 Continuo/Autolimpieza / Continuous/Self-cleaning / Continu/Autonettoyant | | | |
| Producción horaria Hourly production Production horaire | 40/30/24 | | | | |
| Tensión/Frecuencia Electrical data [V/Hz] Tension électrique | 230/50/1N | | 400/50/3N | | |
| Material Matériel | AISI 304 | | | | |
| Potencia Máx. funcionam. Max. operating power [W] Puissance maximale | 3500 | | 8700 | 9500 | 8700 |
| Pot. resistencia cuba Power tank resist. [W] Puiss. résist. cuvette | 600 | 2100 | 2500 | 2500 | 2500 |
| Pot. resist. boiler Boiler resist. power [W] Puiss. résist. boiler | 2600 | 3000 | 8000 | | |
| Pot. bomba lavado Whash. pump power [W] Puiss. bombe lavé | 200 | 470 | 650 | 1500 | 650 |
| Temp. Lavado/Aclar. Wash/rinse temp. [°C] Temp. lavage/rinçage | 60°C/80°C | | | | |
| Capacidad cuba/boiler Tank/boiler capacity [L] Capacité cuvette | 9/2,6 | 20/6 | | 30/6 | 20/12 |
| Consumo agua x cesta Water/rack consumpt. [L] Consomat. eau x panier | 1,8 | 2,2 | | 2,6 | 2,2 |
| Dotación Endowment Dotation | 1 Cesto vasos/1 platos, 1 conten cubiertos, 1 insertador platos 1 Glass rack/1 plats, 1 storage cutlery, 1 plats inserter 1 panier à verre/1 assiettes, 1 bac couverts, 1 range assiettes | | 1 Cesto vasos, 1 cesto platos, 1 contenedor cubiertos 1 Glass rack, 1 rack plats, 1 storage cutlery 1 panier à verre, 1 range assiettes, 1 bac couverts | | |
| Opcional Optional Options | Kit bomba desagüe sin descarga parcial / Drainage pump kit without partial discharge / Kit pompe de vidange sans décharge partielle | | | | |
| | 203 € | | 247 € | | Serie/Serie/Série |
| | - | - | - | Recuperador de calor LCP4560E DBD RC 7.982 € | - |



Accesorios lavaplatos cúpula / Dishwasher accessories / Accessoires lave-vaisselles

| Descripción Description Description | Medidas (mm) Measures (mm) Mesures (mm) | Imagen Image Image | Código Code Code | Precio Price Prix |
|---|---|---|------------------------|-------------------------|
| Mesa entrada/ salida con entrepaño 700mm Entry/ out table 700 mm Table entrée/sortie 700 mm | 700x575x850 |  | MCP80202 | 520 € |
| Mesa con peto derecha 700mm Table right backsplash 700 mm Table avec dosseret à droite 700 mm | 700x715x850 |  | MCP80200 | 601 € |
| Mesa con peto derecha 1200mm Table right backsplash 1200 mm Table avec dosseret à droite 1200 mm | 1200x715x850 |  | MCP80204 | 833 € |
| Mesa con peto izquierda 700mm Table left backsplash 700 mm Table avec dosseret à gauche 700 mm | 700x715x850 |  | MCP80201 | 601 € |
| Mesa con peto izquierda 1200mm Table left backsplash 1200 mm Table avec dosseret à gauche 1200 mm | 1200x715x850 |  | MCP80203 | 833 € |
| Mesa con fregadero izquierda 700mm. Cuba 50x40cm Table sink left 70 mm Sink 50x40 cm Table avec évier à gauche 700 mmCuve 50x40 cm | 700x715x850 |  | MCP80205L700 | 1.275 € |
| Mesa con fregadero derecha 700mm. Cuba 50x40cm Table sink right 700 mm Sink 50x40 cm Table avec évier à droite 700 mmCuve 50x40 cm | 700x715x850 |  | MCP80206L700 | 1.275 € |

Accesorios lavaplatos cúpula / Dishwasher accesories / Accessoires lave-vaisselles

+Info: www.infrico.com

| Descripción Description Description | Medidas (mm) Measures (mm) Mesures (mm) | Imagen Image Image | Código Code Code | Precio Price Prix |
|--|---|---|------------------------|-------------------------|
| <p>Mesa con fregadero izquierda 1200mm. Cuba 50x40cm</p> <p>Table sink left 1200 mm</p> <p>Table avec évier à gauche 1200 mm. Cuve 50x40 cm</p> | 1200x715x850 |  | MCP80205 | 1.275 € |
| <p>Mesa con fregadero derecha 1200mm. Cuba 50x40cm</p> <p>Table sink right 1200 mm</p> <p>Table avec évier à droite 1200 mm. Cuve 50x40 cm</p> | 1200x715x850 |  | MCP80206 | 1.275 € |
| <p>Mesa prelavado con fregadero y orificio izquierdo de desbrascado 1200mm. Cuba 50x40cm</p> <p>Prewash table sink left 1200 mm</p> <p>Table pré lavage avec évier et orifice à gauche 1200 mm. Cuve 50x40 cm</p> | 1200x715x850 |  | MCP80207 | 1.389 € |
| <p>Mesa prelavado con fregadero y orificio derecho de desbrascado 1200mm. Cuba 50x40cm</p> <p>Prewash table sink right 1200 mm</p> <p>Table pré lavage avec évier et orifice à droite 1200 mm. Cuve 50x40 cm</p> | 1200x715x850 |  | MCP80208 | 1.389 € |
| <p>Anillo de goma para desbrascado</p> <p>Rubber ring</p> <p>Joint en caoutchouc</p> | - |  | 199064 | 99 € |
| <p>Grifo ducha prelavado</p> <p>Prewash faucet shower</p> <p>Robinet pré lavage</p> | - |  | 799003 | 379 € |
| <p>Cubo residuos en inox con ruedas</p> <p>Waste bin inox with casters</p> <p>Poubelle en inox sur roulettes</p> | - |  | 704002 | 448 € |



Lavautensilios y lavaperolas / Dishwasher / Lave-ustensiles

A DESTACAR

Se trata de la solución ideal para obradores de panadería, pastelería y heladería.

Estructura en doble pared en acero Inox, este diseño nos permite reducir la dispersión térmica y acústica. Obtenemos valores de dispersión térmica de más de un -60%.

Brazos de lavado y aclarado en paralelo superior e inferior en composite, excepto en los modelos LP8570 y LP85132 que son en acero inoxidable, garantizan resultados óptimos de lavado.

Nueva placa electrónica común para todos los modelos.

Display con pantalla LCD a color, permite visionar temperatura de lavado, aclarado, códigos de errores, programas y fases del programa.

Nueve programas de lavado, cinco básicos de duración en segundos 120, 240, 360, 720, autolimpieza **ProSelf** y cuatro adicionales.

Puerto USB de conexión para actualizar el software y programación.

Diseño de la cuba con cantos redondeados y ausencia de tapón rebosadero, todos los modelos equipan bomba de desagüe, con renovación parcial del agua de lavado.

Filtro de cuba en acero inoxidable. Bombas de lavado con sistema **DuoFlo**, sistema de bomba de lavado con una entrada y dos salidas, se elimina pérdida de potencia y se consigue una disminución del ruido, mejorando el rendimiento y reduciendo el consumo a la vez que se garantiza un mejor y mayor reparto del caudal del agua de lavado.

Sistema de aclarado **UltraRinse** (presión de aclarado constante), nos permite mantener temperatura del agua constante durante la fase de aclarado, así como una presión y caudal del agua del aclarado constante independientemente de las condiciones de la red hidráulica.

De serie, dosificador de abrillantador y detergente peristálticos, con posibilidad de regularlos en el panel de mandos.

Todos los modelos equipan de serie **bomba de aclarado y bomba de desagüe** con descarga parcial, lo que significa que durante el lavado se introduce agua limpia en la cuba para sustituir la sucia, se realizan aportaciones continuas de agua limpia, cuando termina el ciclo parte del agua de la cuba ha sido renovada.

Opcional:

Soportes bandejas, contenedor cubiertos inox, insertador en forma de embudo para confitería, etc.

Brazos de lavado acero inoxidable
Stainless steel washing arm
Bras de lavage en acier inoxydable



Auto limpieza de la cuba
Self-cleaning drum
Auto-nettoyage de la cuve

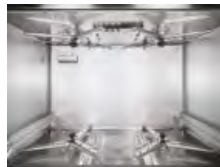

Cuba estampada
Printed drum
Cuve emboutie



Á SOULIGNER

C'est la solution idéale pour les boulangeries, pâtisseries et magasins de crème glacée.

Structure à double paroi en acier inoxydable, cette conception nous permet de réduire la dispersion thermique et acoustique. Nous obtenons des valeurs de dispersion thermique supérieures à -60%.

Les bras de lavage et de rinçage parallèles supérieurs et inférieurs en composite, à l'exception des modèles LP8570 et LP85132, qui sont en acier inoxydable, garantissent des résultats de lavage optimaux.

Nouvelle carte électronique commune à tous les modèles.

L'affichage avec écran LCD couleur permet de visualiser la température de lavage, le rinçage, les codes d'erreur, les programmes et les phases du programme.

Neuf programmes de lavage, cinq basiques d'une durée de 120, 240, 360, 720, auto-nettoyage **ProSelf** et quatre autres.

Port de connexion USB pour mettre à jour le logiciel et la programmation.

Conception du réservoir avec bords arrondis et absence de bouchon de trop-plein, tous les modèles équipés d'une **pompe de lavage et pompe de vidange** à série, avec renouvellement partiel de l'eau de lavage.

Filtre de réservoir en acier inoxydable.

Gran capacidad de trabajo

High working capacity
Grande capacité de travail



| | | | | | |
|---------------------------------|--|-------|---|-------|---|
| Opcional Optional Options | Soporte 8 bandejas prof. máx. 4cm para LP (50x50cm) Support 8 trays max. depth 4cm for LP (50x50cm) Support 8 plateaux profond. maxi 4cm pour LP (50x50cm) | 177 € | Soporte Inox 5 bandejas para LP prof. máx. 6,5cm (50x50cm) Support stainless steel 5 trays for LP max. depth 6,5cm (50x50cm) Support inox 5 plateaux profond. maxi 6,5 cm pour LP (50x50cm) | 208 € | |
| | Contenedor cubiertos inox LP Cutlery storage stain. steel LP Récipient couverts inox LP | 95 € | Insertador embudo para confitería LP Funnel inserter for pastry LP Inserteur entonnoir à boulangerie LP | 70 € | Soporte para cestas LP4060 Rack holder LP4060 Support pour paniers LP4060 |

Serie / Series / Série LP

+Info: www.infrico.com



| MODELO/MODELE/MODÈLE | LP4060 | LP6561 | LP8561 | LP8570 | LP85132 |
|---|---|---|---|---|---|
| Precio Price Prix | 4.413 € | 7.392 € | 8.870 € | 12.139 € | 18.335€ |
| Medidas Measures (mm) Mesures | 600x700 [1135] x1228 | 719x782 [1180] x1727 [1997] | 719x782 [1330] x1927 [2243] | 853x857 [1400] x1959 [2274] | 1465x857 [1400] x1959 [2274] |
| Medidas de cesta Rack measures (mm) Mesures de panier | 500x600 | 550x610 | | 700x700 | 1320x700 |
| Altura útil de lavado Washing height (mm) Hauteur utile de lavage | 405 / 380 | 650 / 600 | 850 / 800 | | |
| Ciclos de lavado estándar Standard washing cycles Durée du cycle | 9 Ciclos, 5 básicos 120, 240, 360, autolimpieza y 720 9 Cycles, 5 basic cycles 120, 240, 360, self-cleaning and 720 9 Cycles, 5 basiques 120, 240, 360, autonettoyage et 720 | | | | |
| Producción horaria Hourly production Production horaire | 30 | | | | |
| Tensión/Frecuencia Electrical data (V/Hz) Tension électrique | 400/50/3N | | | | |
| Material Matériel | AISI 304 | | | | |
| Potencia Máx. funcionam. Max. operating power (W) Puissance maximale | 9800 | 7500 | | 10700 | 15900 |
| Pot. resistencia cuba Power tank resist. (W) Puiss. résist. cuvette | 2100 | 3000 | | 8000 | 10500 |
| Pot. resist. boiler Boiler resist. power (W) Puiss. résist. boiler | 7000 | 6000 | | 8000 | 10500 |
| Pot. bomba lavado Whash. pump power (W) Puiss. bombe lavé | 700 | 1500 | | 3000 | 2 x 2700 |
| Temp. Lavado/Aclar. Wash/rinse temp. (°C) Temp. lavage/rinçage | 55°C a 65°C/80°C a 85°C | | | | |
| Capacidad cuba/boiler Tank/boiler capacity (L) Capacité cuvette | 23/7 | 37/12 | | 68/12 | 131/17 |
| Consumo agua x cesta Water/rack consumpt. (L) Consomat. eau x panier | 2,4 | 3 | | 4 | 6 |
| Dotación Endowment Dotation | 1 Cesto universal inoxidable 1 Universal stainless steel rack 1 Panier universal inoxydable | 1 Cesto universal inoxidable 1 Universal stainless steel rack 1 Panier universal inoxydable | | 1 Cesto universal inoxidable 1 Universal stainless steel rack 1 Panier universal inoxydable | 1 Cesto universal inoxidable 1 Universal stainless steel rack 1 Panier universal inoxydable |
| Opcional Optional Options | - | Recuperador de calor LP8561 RC 10.658 € | Recuperador de calor LP8570 RC 12.136 € | Recuperador de calor LCP4560E DBD RC 15.406 € | Recuperador de calor LP85132 RC 21.602 € |



Túneles de lavado y arrastre / Rack conveyor dishwasher / Tunnels de lavage

A DESTACAR

Estructura fabricada en doble pared en acero inox, este diseño nos permite reducir el ruido y la pérdida de calor. Puertas en doble pared con aislamiento.

Altura útil de carga 450mm, nos permite lavar objetos de mayor tamaño.

Diseño realizado para facilitar su limpieza, cuba de lavado embutida sin tubos interiores con sistema de doble y triple filtro de suciedad del agua, con recogida de residuos.

Filtrado secuencial exclusivo en los modelos TA31111 y TA31112, se trata de la combinación de filtros y de otros filtros de cajón, ambos en la cuba, estos sistemas nos permiten realizar un filtrado progresivo del agua del lavado quedando depositadas todas las partículas de diámetro superior a 1mm. Estos filtros de cajón son extraíbles.

En la aspiración de cada bomba hay otro filtro de seguridad para el agua.

Modelos TA31102 y TA31112 con módulo de prelavado de 820mm de longitud y cuba de 70L, sistema de lavado compuesto por 3 brazos y una bomba de lavado de doble flujo de 1500W.

Módulo de lavado de longitud 1150mm con una cuba de 70 l y sistema de lavado de 5 brazos con bomba de lavado de doble flujo.

Bomba de lavado con sistema DuoFlow, se elimina la división del flujo obteniendo menores pérdidas de carga y menor ruido.

Modelo TA31101 y TA31102 con dos programas de lavado, TA31111 y TA31112 con cuatro programas de lavado.

Sistema de aclarado con presión de red de agua entre 2 y 4.

Brazos de aclarado fabricados en composite, disponen en su interior unas canalizaciones que aseguran el flujo de agua con la menor carga posible. Boquillas fabricadas en acero.

Modelos TA31111 y TA31112 con sistema de aclarado ProRinse, que utiliza una bomba de aclarado de 200W que garantiza una presión y caudal constante del agua del aclarado sean cuales sean las condiciones de suministro de la red. Estos modelos concretos disponen del aclarado proporcional que permite variar la cantidad del agua del aclarado en función del programa de lavado permitiendo hasta un ahorro del consumo del agua del 25%.

Modelo TA31111 Lavado y aclarado con accesorios opcionales

Model TA31111
Washing and rinsing with optional accessories

Modèle TA31111
lavage et rinçage avec accessoires en options

BENEFITS

Structure made in double wall in stainless steel, this design allows us to reduce noise and loss of heat. Double wall doors with insulation. Useful loading height 450mm, allows us to wash larger objects.

Designed to facilitate cleaning, built-in wash tub without internal tubes with double and triple filter system of dirt from the water, with waste collection.

Exclusive sequential filtering on the TA31111 and TA31112 models, this is the combination of filters and other drawer filters, both in the tank, these systems allow us to perform a progressive filtering of the washing water, leaving all particles with a diameter greater than 1mm. These drawer filters are removable.

In the suction of each pump there is another filter of safety for the water.

Models TA31102 and TA31112 with prewash module of 820mm length and 70L tub, washing system composed of 3 arms and a dual flow washing pump of 1500W.

Wash module of length 1150mm with a tank of 70 l and system of washing of 5 arms with pump of washing of double flow.

Wash pump with DuoFlow system, eliminates the division of the flow obtaining smaller losses of load and less noise.

Model TA31101 and TA31102 with two washing programs, TA31111 and TA31112 with four washing programs.

Rinse system with water supply pressure between 2 and 4 bar.

Rinse arms made of composite, have pipes inside that ensure the flow of water with the lowest possible load. Nozzles made of steel.

Models TA31111 and TA31112 with ProRinse rinse system, which uses a 200W rinse pump to ensure a constant pressure and flow rate of the rinse water regardless of the supply conditions of the network. These specific models have a proportional rinse that allows the amount of rinse water to be varied depending on the washing program, allowing up to 25% water consumption savings.

À SOULIGNER

Structure à double paroi en acier inoxydable, cette conception nous permet de réduire les pertes de bruit et de chaleur. Portes à double paroi avec isolation.

Hauteur utile 450 mm, nous permet de laver des objets plus gros.

Conçu pour faciliter le nettoyage, bac de lavage embouti sans tubes intérieurs avec système double et triple filtre de la saleté de l'eau, avec la collecte des déchets.

Filtrage séquentiel exclusif sur les modèles TA31111 et TA31112, il s'agit de la combinaison de filtres et d'autres filtres à tiroir, tous deux installés dans le réservoir. Ces systèmes nous permettent d'effectuer un filtrage progressif de l'eau de lavage en laissant toutes les particules présentes dans le réservoir (diamètre supérieur à 1mm). Ces filtres à tiroir sont amovibles.

Dans l'aspiration de chaque pompe, il y a un autre filtre de sécurité de l'eau.

Modèles TA31102 et TA31112 avec module de prélavage de 820mm de long et réservoir de 70L, système de lavage composé de 3 bras et d'une pompe de rinçage à double flux de 1500W.

Module de lavage de 1150 mm de long avec cuvette de 70 l et système de lavage à 5 bras avec pompe de lavage à double flux.

Pompe de lavage avec système DuoFlow, la division du flux est éliminée, ce qui permet d'atténuer les pertes de charge et le bruit.

Modèles TA31101 et TA31102 avec deux programmes de lavage, TA31111 et TA31112 avec quatre programmes de lavage.

Système d'allègement avec une pression du réseau d'eau comprise entre 2 et 4 bras d'allègement en composite, ils comportent des canaux intérieurs qui assurent le débit d'eau avec la charge la plus faible possible.

Buses en acier.

Les modèles TA31111 et TA31112 avec le système de rinçage ProRinse, qui utilise une pompe de rinçage 200 W, garantissent une pression et un débit constants de l'eau de rinçage quelles que soient les conditions d'alimentation du réseau. Ces modèles disposant d'un rinçage proportionnel qui permet de faire varier la quantité d'eau de rinçage en fonction du programme de lavage, permettant ainsi d'économiser jusqu'à 25% de la consommation d'eau.



Serie / Series / Série TA

+Info: www.infrico.com

Modelo TA31102/31112
Prelavado, lavado y aclarado
con accesorios opcionales.

Model TA31102/31112
 Pre-washing, washing and rinsing with
 optional accesories.

Modèle TA31102/31112 Prélavage,
 lavage et rinçage avec accessoires
 en options.



| MODELO/MODELE/MODÈLE | TA31101 Lavado y Aclarado Wash, Rinse Lavage, Rinçage | TA31102 Prelavado, Lavado, Aclarado Pre-wash, Wash, Rinse Prélavage, Lavage, Rinçage | TA31111 Lavado y Aclarado Wash, Rinse Lavage, Rinçage | TA31112 Prelavado, Lavado, Aclarado Pre-wash, Wash, Rinse Prélavage, Lavage, Rinçage | |
|---|---|---|--|---|-------|
| Precio Price Prix | 11.799 € | 18.898 € | 14.850 € | 21.952 € | |
| Medidas Measures (mm) Mesures | 1150x770x1615(2088) | 1968x770x1615 (2088) | 1150x770x1615 (2088) | 1968x770x1615 (2088) | |
| Medidas de cesta Rack measures (mm) Mesures de panier | 500x500 | | | | |
| Altura útil de lavado Washing height (mm) Hauteur utile de lavage | 450 | | | | |
| Productividad máxima Max. productivity Productivité max. (cestas/h. racks/h. paniers/h) | Máx. capacidad / Max. capacity / Max. capacité | 120 | 200 | 160 | 270 |
| | Baja velocidad / Low speed / Faible vitesse | 60 | 110 | 60 | 110 |
| | Tercera velocidad / 3rd speed / 3eme vitesse | - | - | 120 | 200 |
| | Vasos / glasses / verres | - | - | 80 | 135 |
| Tensión/Frecuencia Electrical data (V/Hz) Tension électrique | 400/50/3N | | | | |
| Potencia Total Max. power (W) Puissance maximale | Agua caliente / Hot water / Eau chaude 50° | 22000 | 29500 | 22000 | 29700 |
| | Agua fría / Cold water / Eau froide 10° | 28500 | 41000 | 31700 | 41200 |
| | Agua fría con recuperador de calor / Cold water with heat recovery / Eau glacée avec recuperation de chaleur | 24700 | 34200 | 24900 | 34400 |
| Pot. resistencia cuba Power tank resist. (W) Puiss. résist. cuvette | 10500 | | | | |
| Pot. resist. boiler Boiler resist. power (W) Puiss. résist. boiler | 9500/1600/12000 | 15500/27000/20000 | 9500/19000/12000 | 15500/27000/20000 | |
| Pot. bomba lavado / Whashing / Pre-washing pump power / (W) Puissance bombe lavage / pré-lavage | 1500 / - | 1500 / 1500 | 1500 / - | 1500 / 1500 | |
| Temp. Lavado/Aclar. Wash/rinse temp. (°C) Temp. lavage/rinçage | Máx. capacidad / Max. capacity / Max. capacité | 60°C/82°C | | 63°C/82°C | |
| | Baja velocidad / Low speed / Faible vitesse | 60°C/82°C | | 63°C/82°C | |
| | Tercera velocidad / 3rd speed / 3eme vitesse | - | | 60°C/82°C | |
| | Vasos / glasses / verres | - | | 60°C/65°C | |
| Consumo agua x cesta Water/rack consumpt. (L) Consomat. eau x panier | 160 | 270 | 140-200 | 240-320 | |
| Capacidad cuba/boiler Tank/boiler capacity (L) Capacité cuvette | 70/17 | | | | |
| Dotación Endowment Dotation | 1 Cesto platos, 1 cesto plano, 1 contenedor cubiertos / 1 Plats rack, 1 flat rack, 1 storage cutlery / 1 panier assiettes, 1 range plat, 1 bac couverts | | | | |



Accesorios lavavajillas de arrastre / Tunnels of wash accesories / Accessoires tunnels de lavage

| Descripción Description Description | Medidas (mm) Measures (mm) Mesures (mm) | Imagen Image Image | Código Code Code | Precio Price Prix |
|--|--|--|------------------------|-------------------------|
| Prelavado en ángulo Angle pre-wash Prélavage en angle TA31102, TA31112 (P) | 990x820x1565 |  | P | 2.569 € |
| Modulo secado Túnel Arrastre Drying module Tunnel conveyor Module séchage tunnel TA (A) | 600x770x177,5 |  | A | 4.988 € |
| Modulo secado Túnel Arrastre Drying module Tunnel conveyor Module séchage tunnel TA (L) | 600x770x1775 | | L | 5.350 € |
| Modulo secado en ángulo Angle drying module Module séchage en angle TA (B) | 820x879x1775 |  | B | 9.805 € |
| Modulo secado en ángulo Angle drying module Module séchage en angle TA (I) | 820x879x1775 | | I | 10.154 € |
| Extractor vapor Steam extractor Extracteur de vapeur (E) | Diámetro 25- h 21 Diameter 25- h 21 Diamètre 25- h 21 |  | E | 1.234 € |
| Recuperador de calor condensador de vahos Vapour condenser heat recovery unit Récupérateur de chaleur ou condensateur de buées TA (R) | Diámetro 25- h 21 Diameter 25- h 21 Diamètre 25- h 21 |  | R | 4.235 € |
| Kit aumento resistencia calderín 9,5Kw (W) Kit to increase boiler resistance 9,5Kw [W] Kit supplément résistance 9,5Kw [Réf. W] | - |  | W | 335 € |
| Dosificador de detergente y abrillantador TA (Y) Detergent and rinse aid dosing unit TA [Y] Doseur de détergent et brillant TA [Réf. Y] | - |  | Y | 445 € |
| Interruptor Bloqueo emergencia (X) Emergency lock switch [X] Interrupteur blocage urgence [Réf. X] | - |  | X | 206 € |
| Reducción de presión con manómetro Pressure reduction with gauge Réduction de pression avec manomètre TA 31101, Ta31102 (N) | - |  | N | 307 € |
| Sonda nivel producto químico Chemical level sensor Sonde niveau produit chimique | - |  | 999257 | 98 € |
| Kit micro interruptor final de carrera Limit switch micro kit Kit micro interrupteur fin de course | - |  | 75861 | 193 € |

Cuba embutida
Stamped pan
Cuve emboutie



Filtro
Filter
Filtre



Bomba lavado Duoflow
Washing pump Duoflow
Pompe lavage Duoflow



Otras medidas o modelos consultar disponibilidad y precio.

For any other measurement or models, consult availability and price.

Autres dimensions et modèles, nous consulter.

Accesorios lavavajillas de arrastre / Tunnels of wash accesories / Accessoires tunnels de lavage

+Info: www.infrico.com

| Descripción Description Description | Medidas (mm) Measures (mm) Mesures (mm) | Imagen Image Image | Código Code Code | Precio Price Prix |
|---|---|---|------------------------|-------------------------|
| Mesa entrada/salida con entrepaño 700-1100mm Entry/ out table 700-1100 mm Table entrée/sortie 700-1100 mm | 700x700x850 |  | 75482 | 894 € |
| | 1100x700x850 | | 75483 | 924 € |
| Mesa entrada/salida para secado 700-1100mm Entry/out table for drying 700-1100mm Table entrée/sortie pour séchage 700-1100mm | 700x700x850 |  | 75484 | 990 € |
| | 1100x700x850 | | 75485 | 1.020 € |
| Mesa esquina para máquina con salida izquierda Corner table for machine with left exit Table angle avec sortie à gauche | 600x650x850 |  | 75480 | 2.108 € |
| Mesa esquina para máquina con salida derecha Corner table for machine with right exit Table angle avec sortie à droite | 600x650x850 |  | 75481 | 2.108 € |
| Mesa con fregadero (50x40cm) Máquina salida derecha 1200-1500-1800mm Sink table (50x40cm) Machine right exit 1200-1500-1800mm Table avec évier (50x40cm) sortie à droite 1200-1500-1800mm | 1200x700x850 |  | 75451 | 1.538 € |
| | 1500x700x850 | | 75452 | 1.657 € |
| | 1800x700x850 | | 75453 | 1.761 € |
| Mesa con fregadero (50x40cm) máquina salida izquierda 1200-1500-1800mm Sink table (50x40cm) Machine left exit 1200-1500-1800mm Table avec évier (50x40cm) sortie à gauche 1200-1500-1800mm | 1200x700x850 |  | 75456 | 1.538 € |
| | 1500x700x850 | | 75457 | 1.657 € |
| | 1800x700x850 | | 75458 | 1.761 € |
| Mesa prelavado con fregadero (50x40cm) y desbrasado para máquina salida derecha 1200-1500-1800mm Sink prewash table (50x40cm) Machine right exit 1200-1500-1800mm Table pré lavage avec évier (50x40cm) sortie à droite 1200-1500-1800mm | 1200x700x850 |  | 75446 | 1.751 € |
| | 1500x700x850 | | 75447 | 1.954 € |
| | 1800x700x850 | | 75448 | 2.153 € |
| Mesa prelavado con fregadero (50x40cm) y desbrasado para máquina salida izquierda 1200-1500-1800mm Sink prewash table (50x40cm) Machine left exit 1200-1500-1800mm Table pré lavage avec évier (50x40cm) sortie à gauche 1200-1500-1800mm | 1200x700x850 |  | 75441 | 1.751 € |
| | 1500x700x850 | | 75442 | 1.954 € |
| | 1800x700x850 | | 75443 | 2.153 € |
| Mesa rodillos con cuba y patas 1100-1600-2100-2600mm (Elemento de cierre +45mm) Roller table with tank and legs 1100-1600-2100-2600mm (closing element +45mm) Table à rouleaux avec cuve et pieds 1100-1600-2100-2600mm (élément fermeture +45mm) | 1145x630x875 |  | 717066 | 1.741 € |
| | 1645x630x875 | | 717067 | 2.296 € |
| | 2145x630x875 | | 717086 | 3.045 € |
| | 2645x630x875 | | 717087 | 3.765 € |
| Mesa rodillos con cuba y patas sobre ruedas 1100-1600-2100mm (Elemento de cierre +45mm) Roller table with bowl and legs on casters 1100-1600-2100mm (closing element +45mm) Table à rouleaux avec cuve et pieds sur roulettes 1100-1600-2100mm (élément fermeture +45mm) | 1145x630x875 |  | 717069 | 3.045 € |
| | 1645x630x875 | | 717070 | 3.596 € |
| | 2145x630x875 | | 717088 | 4.821 € |
| Curva con rodillos 90° Roller curve 90° Table courbe à rouleaux 90° | 1100x1100x875 |  | 717068 | 2.584 € |



Congelador tapa abatible / Lid chest freezer / Congélateur avec couvercle battant

Serie / Series / Série **HF**

HF 500 AL HC

Controlador digital
Adjustable thermostat
Thermostat réglable



| MODELO/MODELE/MODÈLE | HF 240 AL HC | HF 320 AL HC | HF 400 AL HC | HF 500 AL HC | HF 550 AL HC | HF 700 AL HC | |
|---|--|-------------------|--------------------|---------------------------------------|--------------------|---|--|
| Precio Price Prix | 521 € | 564 € | 602 € | 678 € | 773 € | 1.282 € | |
| Medidas Measures [mm] Mesures | 830 660 860 | 990 660 860 | 1170 660 860 | 1400 660 860 | 1600 660 860 | 1570 751 1027 | |
| Tensión/Frecuencia Electrical data [V/Hz] Tension électrique | 220V-240V/50Hz | | | | | | |
| Material Material Matériel | Ext: Chapa galvanizada plastificada blanco / Galvanised steel white plastic coated / Tôle galvanisée plastifiée blanc. Int: Caba interior en aluminio / Aluminium inner tank / Cuve intérieure en aluminium | | | | | | |
| Capacidad Capacity [L] Capacité | 176 | 220 | 285 | 344 | 439 | 664 | |
| Nº Cesta [serie/opción] Nº baskets [standard/optional] Nº Paniers [série/option] | 2/0 | 2/1 | 2/2 | 2/3 | 2/4 | 2/4 | |
| Compresor Compressor Compresseur | 1/9 | 1/9 | 1/7 | 1/6 | 1/3 | 1/3 | |
| Temperatura Temperature [32°C] Température | -17°C / -25°C | | | | | | |
| Condensación Condensation Condenseur | Estática / Static / Statique | | | | | Ventilada / Ventilated / Ventilée | |
| Evaporación Evaporation Évaporateur | Estática / Static / Statique | | | | | | |
| Desescarche Defrost [Kg.] Dégivrage | Manual / Manual / Manuel | | | | | | |
| Capac. Congelación Freezing capacity Puissance congélation | 12 | 16 | 18 | 20 | 24 | 42 | |
| Potencia Power [W] Puissance | 133 | 130 | 161 | 180 | 195 | 220 | |
| Refrigerante Refrigerant Gaz | HC R600a | | | | | R290 | |
| Clase energética Energy class Classe énergétique | F | | | | | - | |
| Opcional Optional Options | | | | Cesta / Basket / Panier | 22 € | | |
| | | | | Cesta / Basket / Panier HF 700 | 22 € | | |

Conservadora puerta corredera / Sliding doors conservator / Congélateur avec couvercle coulissant

Serie / Series / Série **HF**

HF 400 TCG

Controlador digital
Adjustable thermostat
Thermostat réglable



Mod. TCC
Tapa ciega
Solid lid
Couvercle plein



Mod. TCG
Tapa cristal con llave
Glass lid with key
Couvercle en verre avec clé

| MODELO/MODELE/MODÈLE | HF 300 TCGHC HF 300 TCC HC | HF 400 TCGHC HF 400 TCC HC | HF 500 TCGHC HF 500 TCC HC |
|--|--|-------------------------------|-------------------------------|
| Precio Price Prix | 785 € 705 € | 865 € 772 € | 931 € 838 € |
| Medidas  Measures (mm) Mesures | 1063 670 900 | 1283 670 900 | 1503 670 900 |
| Tensión/Frecuencia Electrical data [V/Hz] Tension électrique | 220V-240V/50Hz | | |
| Material Material Matériel | Ext: Chapa galvanizada plastificada blanco / Galvanised steel white plastic coated / Tôle galvanisée plastifiée blanc. Int: Cuba interior en aluminio / Aluminium inner tank / Cuve intérieure en aluminium | | |
| Capacidad Capacity [L] Capacité | 256 | 327 | 398 |
| Nº Cesta [serie/opción] Nº baskets [standard/optional] Nº Paniers [série/option] | Mod. TCG 2/2 Mod. TCC - | Mod. TCG 2/3 Mod. TCC - | Mod. TCG 2/4 Mod. TCC - |
| Compresor Compressor Compresseur | 1/6 | 1/3 | 1/3 |
| Temperatura Temperature [32°C] Température | -18°C / -24°C | | |
| Condensación Condensation Condenseur | Ventilada / Ventilated / Ventilée | | |
| Evaporación Evaporation Évaporateur | Estática / Static / Statique | | |
| Desescarche Defrost [Kg.] Dégivrage | Manual/ Manual / Manuel | | |
| Capac. Congelación Freezing capacity Puissance congélation | 23 | 25 | 27 |
| Potencia Power [W] Puissance | 135 | 190 | 190 |
| Refrigerante Refrigerant Gaz | HC R600a | | |
| Clase energética Energy class Classe énergétique | F | | |
| Opcional Optional Options | Cesta / Basket / Panier TCG 29 € | | |



Congeladores tapa abatible -70°C / -60°C

Lid Chest freezers -70°C / -60°C

Congélateurs avec couvercle battant -70°C / -60°C

IDEAL PARA ALMACENAR
ATÚN PARA SUSHI



Controlador digital
Adjustable thermostat
Thermostat réglable

IDEAL FOR STORING
TUNA FISH FOR SUSHI



IDÉAL POUR CONSERVER
LE THON POUR LE SUSHI



Controlador digital
Adjustable thermostat
Thermostat réglable

| MODELO MODELE MODÈLE | NEW -70°C UL100 | PRO 11 | PRO 21 | -60°C PRO 31 | PRO 41 | PRO 60 |
|--|---|---|----------------------------|----------------------------|----------------------------|----------------------------|
| Precio Price Prix | 1.490 € | 3.300 € | 4.023 € | 4.581 € | 4.822 € | 5.236 € |
| Temperatura Temperature Température (°C) | -40°C/-70°C | -30°C/-60°C | | | | |
| Medidas Measures Mesures (EXT) | 610 x 650 x 850 mm. | 725 x 655 x 865 mm. | 1055 x 655 x 865 mm. | 1305 x 655 x 865 mm. | 1505 x 655 x 865 mm. | 1705 x 655 x 865 mm. |
| Medidas Measures Mesures (INT) | 460 x 440 x 487 mm. | 520 x 450 x 650 mm. | 850 x 450 x 650 mm. | 1100 x 450 x 650 mm. | 1300 x 450 x 650 mm. | 1540 x 450 x 650 mm. |
| Tensión/Frecuencia Electrical data Tension électrique | 220-240V/50Hz | 220V/50Hz | | | | |
| Controlador Controller Régulateur | Danfoss Digital [Sin alarma/Without alarm/Sans alarme] | Dixell Digital con alarma acustica / Contacto libre para conectar a alarma externa / Dixell Digital with acoustic alarm / Free contact for connection to external alarm / Dixell Digital avec alarme sonore / Contact libre pour connexion à une alarme externe | | | | |
| Aislamiento Isolation Isolation (mm) | 70 | 102,5 | | | | |
| Capacidad Capacity Capacité [L NETOS] | 99 | 130 | 226 | 300 | 360 | 481 |
| Nº Cesta [serie/opción] Nº baskets [standard/optional] Nº Paniers [série/option] | 1/0 | 0/2 | 0/3 | 0/4 | 0/5 | - |
| Condensación Condensing Condensation | Condensador interior en parte trasera, condensador estatico en la trasera y ventilador de apoyo al compresor / Inner rear condenser, rear static condenser and compressor support fan / Condenseur intérieur à l'arrière, condenseur statique à l'arrière et ventilateur de support du compresseur. | | | | | |
| Evaporador Cooler Évaporateur | Estático (tubo de aluminio) / Static (aluminium tube) / Statique (tube d'aluminium) | | | | | |
| Desescarche Defrost Dégivrage | Manual / Manual / Manuel | | | | | |
| Potencia Power Puissance [W] | 480 | 375 | 455 | 544 | 587 | 612 |
| Consumo Consumption Consommation [kWh/ 24h] | 6 | 4,3 | 5 | 5,2 | 6,1 | 9,2 |
| Refrigerante Refrigerant Gaz | R290 + R170 | R600a + R1150 | | | | |
| Opcional Optional Options | - | | | | | |

Serie / Series / Série **PRO**



UL100



UL100



PRO 11



PRO 21



PRO 31



PRO 41



PRO 60



Conservadora expositora puerta cristal / Horizontal freezer with glass LID / Conservateur panoramique congélation

Serie / Series / Série **IL**

Aislamiento (100% libre de CFC'S), con 60 mm de espesor >=42,5Kg/m³.

Evaporador y condensador en tubería de cobre.

Condensador libre mantenimiento.

Controlador digital.

Tapas correderas de cristal, marco calentado para evitar bloqueo de tapas.

Injected insulation (100% CFC'S free) with 60 mm thickness >=42,5Kg/m³.

Evaporator and condensator in copper.

Free maintenance condenser. Digital controller.

Sliding glass lid, heated frame to avoid blocking of lids

Isolation (100% sans CFC `S), 60 mm d'épaisseur >=42,5Kg/m³.

Évaporateur et condensateur avec tuyauterie en cuivre.

Thermostat réglable.

Thermomètre analogique.

Dessus portes coulissantes vitrées, encadrement chauffé pour éviter le blocage des portes vitrées.

Serie / Series / Série **CHE**

Aislamiento (100% libre de CFC'S), con 70 mm de espesor >=42,5Kg/m³.

Evaporador y condensador en tubería de cobre.

Condensador de libre mantenimiento. Controlador digital.

Tapas correderas de cristal (Mod. TC) o tapa abatible (Mod. TA), con marco calentado para evitar el bloqueo de tapas.

Iluminación interior.

Injected insulation (100% CFC'S free) with 70 mm thickness >=42,5Kg/m³.

Evaporator and condensator in copper.

Free maintenance condenser. Digital controller.

Sliding glass lid [TC] or lift lid [TA], heated frame to avoid blocking of lids.

Internal illumination.

Isolation (100% sans CFC'S), 70 mm d'épaisseur >=42,5Kg/m³.

Évaporateur et condensateur avec tuyauterie en cuivre.

Condenseur en libre maintenance. Contrôleur digital.

Dessus portes coulissantes (Mod. TC) ou couvercle battant (Mod. TA), avec encadrement chauffé pour éviter le blocage des portes vitrées.

Éclairage intérieur.

| MODELO/MODELE/MODÈLE | IL 1500 HC | IL 2000 HC | IL 2500 HC | CHE 1500 TC HC | CHE 2000 TC HC | CHE 1770 TC HC |
|---|---|---|--|---|--------------------|--|
| Precio Price Prix | 1.966 € | 2.050 € | 2.525 € | 2.544 € | 2.998 € | 3.920 € |
| Medidas Measures (mm) Mesures | 1550 960 780 | 2050 960 780 | 2500 960 780 | 1500 880 940 | 2000 880 940 | 1770 840 900 |
| Tensión/Frecuencia Electrical data [V/Hz] Tension électrique | 220V-240V/50Hz | | | | | |
| Material Material Matériel | Exterior e interior en chapa galvanizada revestida en PVC blanco. Exterior and interior of galvanized steel, white plastic coated. Extérieur et intérieur en tôle galvanisée en PVC blanc. | | | | | |
| Capacidad Capacity (L) Capacité | 459 | 652 | 805 | 350 | 518 | 370 |
| Nº Cesta (serie/opción) Nº baskets (standard/optional) Nº Paniers [série/option] | [1/3]=4 | [1/5]=6 | [1/7]=8 | 0/5 | 0/6 | n/d |
| Divisoria Alta-Baja Divider High-Low Diviseur Haut-Bas | - | | | 1/1 | 1/1 | 1/1 |
| Compresor Compressor Compresseur | 2 [1/5] | 2 [1/5] | 2 [1/5] | 2 [1/5] | 2 [1/5] | 2 [1/5] |
| Temperatura Temperature (3L1) Température | -18°C / -22°C | | | -18°C / -22°C | | |
| Condensación Condensation Condenseur | Ventilada / Ventilated / Ventilée | | | | | |
| Evaporación Evaporation Évaporateur | Estática / Static / Statique | | | | | |
| Desescarche Defrost (Kg.) Dégivrage | Manual/ Manual / Manuel | | | | | Semiautomático / Semi-automatic / Semi-automatique |
| Consumo Consumption (Kwh/24h) Consommation | 3,9 | 4,5 | 4,9 | 7,5 | 8,4 | 9 |
| Potencia Power (W) Puissance | 305 | 345 | 345 | 526 | 526 | 549 |
| Refrigerante Refrigerant Gaz | R290 | | | | | |
| Clase energética Energy class Classe énergétique | C | B | C | E | D | E |
| Opcional Optional Options | Porta precios/Carries prices/Porte prix | | | Porta precios/Carries prices/Porte prix | | |
| | 34 € | 45 € | 61 € | 45 € | 57 € | 48 € |
| | Barra divisoria/Divider bar/Barre de div. grille séparation | | | Kit unión / Union kit / Kit union | | |
| | 59 € | 77 € | 95 € | 149 € | 159 € | 210 € |
| | Cesta/Basket/Panier Cesta pequeña/Small Basket/Petit panier Cubeta plástico/Plastic Basket/Cuve plastique Divisoria alta/High Divider/Grille sépar. haute Divisoria baja/Small divider/Grille sépar. basse | 34 € 22 € 22 € 26 € 20 € | Antracita exterior, consultar Ext. Anthracite, to consult Anthracite extérieur, consulter | Cesta / Basket / Panier 33 € | | |

Serie / Series / Série **IL**
 Serie / Series / Série **CHE**

+Info: www.infrico.com



IL2000HC









CHE2000TCHC(4) + CHE1770TCHC

CHE 1770 TC HC

TC: Tapa corredera
 TC: Sliding lid
 TC: Couvercle coulissant



Conservadora expositora puerta cristal curvada / Conservative of curved glass crystal door / Conservateur panoramique pour surgelés

| MODELO MODELE MODÈLE |  |  |  |  |  |  |  |
|---|---|---|---|---|---|---|---|
| | EHC1500 DEHC | EHC2000 DEHC | EHC2200 DEHC | EHC2500 DEHC | EHC1970 DETHC | EHCD2150 DEHC | EHCD1470 DEHC |
| Precio Price Prix | 2.656 € | 2.904 € | 2.966 € | 3.209 € | 3.190 € | 4.803 € | 2.818 € |
| Temperatura Temperature Température | -16°C/-24°C | | | | | | |

| MOD. | EHCR1500 DEHC | EHCR2000 DEHC | EHCR2200 DEHC | EHCR2500 DEHC | EHCR1970 DET HC | | |
|--|---|----------------------------|----------------------------|----------------------------|----------------------------|---|----------------------------|
| Precio Price Prix | 2.736 € | 2.992 € | 3.055 € | 3.305 € | 3.285 € | | |
| Temperatura Temperature Température | -16°C/-24°C +10°C/-24°C | | | | | | |
| Medidas Measures Mesures | 1520 x 920 x 790 mm. | 2020 x 920 x 790 mm. | 2200 x 920 x 790 mm. | 2500 x 920 x 790 mm. | 1990 x 920 x 790 mm. | 2150 x 1465 x 930 mm. | 1470 x 811 x 902 mm. |
| Clase Climática Climatic class Classe climatique | 3 L1 [25°C/60% Hr] 3 M1 [25°C/60% Hr] | | | | | | |
| Tensión/Frecuencia Electrical data Tension électrique | 230V/1ph/50Hz | | | | | | |
| Controlador Controller Régulateur | Digital | | | | | | |
| Material Material Matériel | Chapa de acero galvanizado, recubierta de PVC / Galvanized sheet steel, PVC coated / Tôle d'acier galvanisée, revêtement en PVC | | | | | | |
| Aislamiento Isolation Isolation | 70mm [42,5kg/m³] / Free CFC's / Zero ODP-GWP | | | | | | |
| Capacidad Capacity Capacité | 400 | 580 | 630 | 750 | 430 | 1255 | 334 |
| Compresor Compressor Compresseur | 2 [1/5] 2 [1/3+] | 2 [1/5] 2 [1/3+] | 2 [1/5] 2 [1/3+] | 2 [1/5] 2 [1/3+] | 2 [1/5] 2 [1/5] | 2 [1/3] | 2 [1/5] |
| Nº Cesta [serie/opción] Nº baskets [standard/optional] Nº Paniers [série/option] | 0/3 | 0/5 | 0/6 | 0/7 | - | - | |
| Divisoria [serie/opción] Divider [standard/optional] Diviseur [série/option] | 1/7 | 2/7 | 2/7 | 2/7 | 2/7 | 4/6 | 2/3 |
| Condensación Condensing Condensation | Ventilado / Ventilated / Ventilé | | | | | | |
| Desescarche Defrost Dégivrage | Automático / Automatic / Automatique | | | | | | |
| Evaporación Evaporation Évaporation | Estática / Static / Estatique | | | | | | |
| Potencia Power Puissance | 598 759 | 662 777 | 662 777 | 681 796 | 656 771 | 672 | 413 |
| Potencia frig. Cooling capacity Puissance Frig. | - | | | | | | |
| Consumo Consumption Consommation | 6,10 7,30 | 6,40 7,50 | 7,00 7,80 | 7,80 8,30 | 6,70 8,80 | 9,2 | 4,10 |
| Clasif. energética Energy classifc. Classif. énergétique | D D | C D | C D | C D | C D | C | |
| Refrigerante Refrigerant Gaz | R-290 | | | | | | |
| Opcional Optional Options | Cesta / Basket / Panier 33 € | | | | | Porta precios / Ticket strip / Porte prix | |
| | Parrilla divisoria / Divider wire / Grille de séparation 38 € | | | | | | |
| | Kit unión / Assembly kit / Kit union | | | | | 153 € | |
| | 144 € | 153 € | 169 € | 187 € | - | | |
| | Porta precios / Ticket strip / Porte prix | | | | | | |
| | 56 € | 65 € | 72 € | 79 € | 41 € | | |
| Rodapie / Skirting board / Plinthe Consultar / To consult / Consulter | | | | | 72 € | | |

Serie / Series / Série **EHC / EHC D**
 Serie / Series / Série **EHC R**



Decor. Exterior
Decor. Exterior
Décor. Ext.

| | | |
|--|--|---|
| Ral 9016 Blanco White Blanc | Negro exterior, consultar Ext. black, to consult Noir extérieur, consulter | Antracita exterior, consultar Ext. Anthracite, to consult Anthracite extérieur, consulter |
|--|--|---|

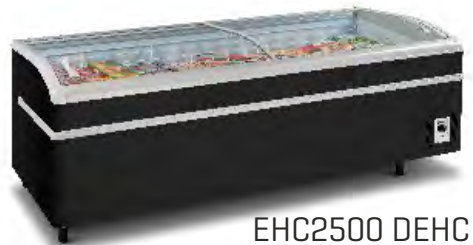
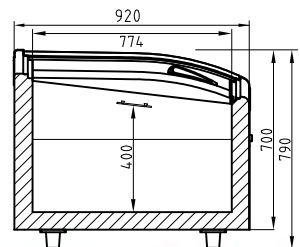

EHC2500 DEHC

Lineal ECH1970 DETHC + ECH2000 DEHC
 ECH1970 DETHC + ECH2000 DEHC Linear assembly
 Assemblage lineaire ECH1970 DETHC + ECH2000 DEHC



EHC1470 DEHC

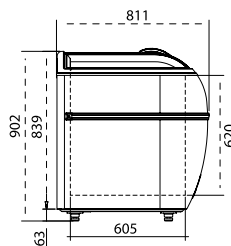
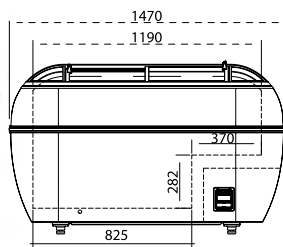

Decor. Exterior
Decor. Exterior
Décor. Ext.



| | | |
|--|--|---|
| Ral 9016 Blanco White Blanc | Negro exterior, consultar Ext. black, to consult Noir extérieur, consulter | Antracita exterior, consultar Ext. Anthracite, to consult Anthracite extérieur, consulter |
|--|--|---|

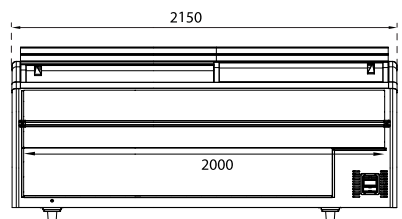
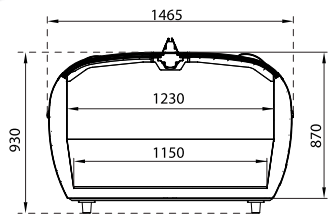

Lineal EHCD2150 DEHC
 EHCD2150 DEHC Linear assembly
 Assemblage lineaire EHCD2150 DEHC



Expositora conservadora horizontal VISION, compresor VSC / Horizontal conservative display VISION, VSC compressor / Conservateur panoramique Vision, compresseur VSC

| MODELO MODELE MODÈLE |  EHCV 2000 VSC |  EHCV 2500 VSC |  EHCV 2000 TVSC |
|--|---|---|---|
| Precio Price Prix | 5.014 € | 5.402 € | 5.027 € |
| Temperatura Temperature Température | +10°C/-22°C | | |
| Medidas Measures Mesures | 1953 x 980 x 970 mm. | 2500 x 980 x 970 mm. | 1983 x 980 x 970 mm. |
| Clase Climática Climatic class Classe climatique | 3 L1 [25°C/60% Hr] 3 M1 [25°C/60% Hr] | | |
| Tensión/Frecuencia Electrical data Tension électrique | 220-240V/50-60Hz | | |
| Controlador Controller Régulateur | Dixell Digital | | |
| Material Material Matériel | Chapa de acero galvanizado, recubierta de PVC / Galvanized sheet steel, PVC coated / Tôle d'acier galvanisée, revêtement en PVC | | |
| Aislamiento Isolation Isolation | 70mm [42,5kg/m ³] | | |
| Capacidad Capacity Capacité | 613 | 821 | 613 |
| Compresor Compressor Compresseur | 1 1/4HP VSC regulación capacidad inverter / 1 1/4HP VSC inverter capacity control / 1 1/4HP VSC contrôle de la capacité inverter | | |
| Nº Puertas Doors Portes | 2 | 2 | 2 |
| Divisoria (serie/opción) Divider (standard/optional) Diviseur (série/option) | 2/7 | 2/7 | 2/7 |
| Condensación Condensing Condensation | Ventilado / Ventilated / Ventilé | | |
| Desescarche Defrost Dégivrage | Automático / Automatic / Automatique | | |
| Evaporación Evaporation Évaporation | Estática / Static / Estatique | | |
| Potencia Power Puissance | 1300 | 1300 | 1300 |
| Potencia frig. Cooling capacity Puissance Frig. | 1000 | 1000 | 1000 |
| Consumo Consumption Consommation | 10,6 | 11,8 | 10,6 |
| Clasif. energética Energy classifc. Classif. énergétique | D | D | D |
| Refrigerante Refrigerant Gaz | R-288 | | |
| | Parrilla divisoria / Divider wire / Grille de séparation | | |
| | 47 € | | |
| | Porta precios / Ticket strip / Porte prix | | |
| Opcional Optional Options | 27 € | 30 € | 27 € |

Serie / Series / Série **EHC VISION VSC**

EHCV2000VSC

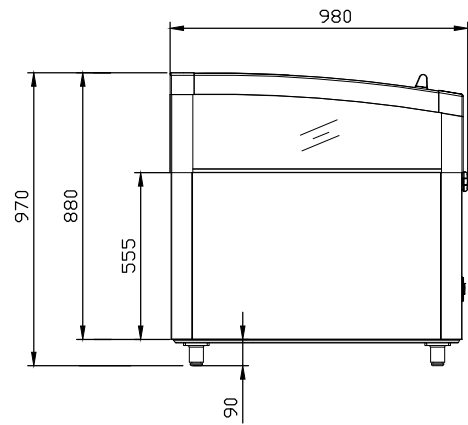

EHCV VSC/TVSC

EHCV2500VSC

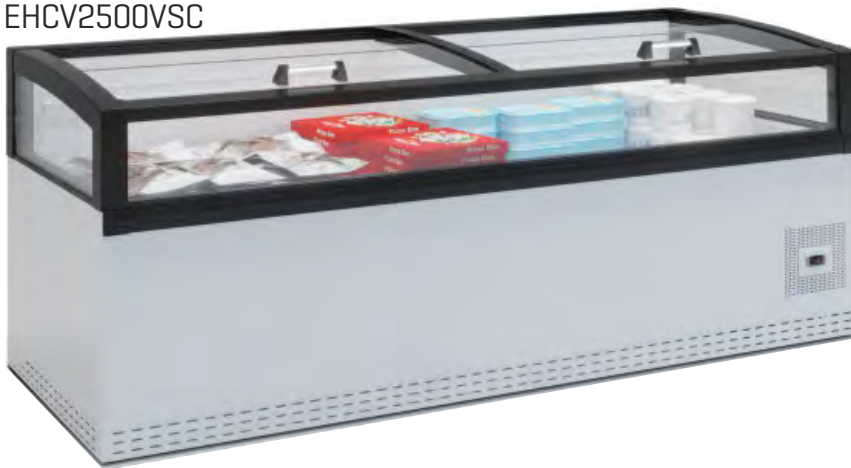
**Decor. Exterior /
Exterior Decor./
Décoration Ext.**

Ral 9016
Blanco
White
Blanc

Negro,
consultar
Black,
to consult
Noir,
consulter

Antracita,
consultar
Anthracite,
to consult
Anthracite,
consulter



Armario de refrigeración y congelación / Chillers and freezers / Congélateur vertical

A DESTACAR

Modelos con puerta ciega SD con tirador integrado en la puerta (RV200ISD y FS200ISD) y modelos con puerta de cristal GD con tirador en acero inoxidable (RV200IGD y FS200IGD).

Puerta de cristal con doble cristal en los modelos de refrigeración, triple cristal templado y calefactado en los modelos de baja temperatura.

Modelos de refrigeración RV con dos estantes regulables y modelos de congelación FS dos estantes no regulables.

Termostato digital.

Cerradura con llave de serie.

Iluminación Led en el modelo de refrigeración con puerta de cristal.

Reguladores en la parte frontal y rodillo en la parte trasera para facilitar el desplazamiento.

BENEFITS

Models with blind door SD with integrated door handle (RV200ISD and FS200ISD) and models with glass door GD with handle in stainless steel (RV200IGD and FS200IGD).

Glass door with double glazing in the cooling models, triple tempered glass and heated in the low temperature models.

RV refrigeration models with two adjustable shelves and FS freezing models, two non-adjustable shelves.

Digital thermostat.

Lock with serial key.

LED lighting in the cooling model with glass door.

Regulators on the front and roller on the back for easy movement.

À SOULIGNER

Modèles avec porte pleine SD avec poignée intégrée dans la porte (RV200ISD et FS200ISD) et modèles avec porte vitrée GD avec poignée en acier inoxydable (RV200IGD et FS200IGD).

Porte avec double vitrage dans les modèles de réfrigération, triple vitrage avec verre trempé et chauffée dans les modèles à basse température.

Modèles de réfrigération RV avec deux niveaux réglables et modèles de congélation FS, deux niveaux non réglables.

Thermostat numérique.

Serrure avec clé de série.

Éclairage Led pour les modèles de réfrigération avec porte vitrée.

Régulateurs frontal et petits rouleaux à l'arrière pour faciliter le déplacement.

| MODELO/MODELE/MODELE | RV 200 ISD | RV 200 IGD | FS 200 ISD | FS 200 IGD |
|---|--|---|-------------------------------|--|
| Precio Price Prix | 812 € | 915 € | 832 € | 1.163 € |
| Medidas Measures [mm] Mesures | 600 620 835 | 600 620 835 | 600 620 835 | 600 620 835 |
| Tensión/Frecuencia Electrical data [V/Hz] Tension électrique | 230V / 50Hz | | | |
| Material Material Matériel | Exterior en acero inoxidable e interior en termoconformado ABS. Exterior in stainless steel and interior in ABS thermoformed. Extérieur en acier inoxydable et intérieur en thermoformage ABS. | | | |
| Capacidad Capacity Capacité | 150 | 150 | 150 | 150 |
| Estantes Shelves Étagères | 2 regulables en altura 2 height adjustable 2 réglables en hauteur | 2 regulables en altura 2 height adjustable 2 réglables en hauteur | 2 fijas 2 fijas 2 fijas | 2 fijas 2 fijas 2 fijas |
| Medidas estantes Shelves dimens. [mm] Mesures étagères | 410x500 | | 450x500 | |
| Puerta Door Porte | Ciega / Solid | Cristal / Glass | Ciega / Solid | Cristal / Glass |
| Temperatura Temperature [32°C] Température | 0°C / +8°C | +2°C / +8°C | -18°C / -21°C | -18°C / -21°C |
| Condensación Condensation Condenseur | Estática / Static / Statique | | | Estática con ventilador Static with cooler Statique avec ventilateur |
| Evaporación Evaporation Évaporateur | Ventilado / Ventilated / Ventilé Roll-bond | | Estática / Static / Statique | |
| Desescarche Defrost Dégivrage | Automático / Automatic / Automatique | | Manual / Manual / Manuel | |
| Consumo Consumption [Kwh/24h] Consommation | 1,7 | 3,2 | 1,66 | 2,8 |
| Potencia Power Puissance | 140 | 140 | 80 | 150 |
| Refrigerante Refrigerant Gaz | HC R600a | | | R290 |
| Opcional Optional Options | - | | | |

Serie / Series / Série **MINI ARMARIO**

+Info: www.infrico.com



RV200ISD



RV200IGD



FS200ISD



FS200IGD

Cerradura
Door lock
Serrure



Interruptor
Switch
Interrupteur



Control digital
Digital control
Contrôle digital



Armario de refrigeración y congelación 400L / 400L Chillers and freezers / Congélateur vertical 400L

A DESTACAR

Modelos con puerta ciega SD con tirador integrado en la puerta (RV400ISD y FS400ISD) y modelos con puerta de cristal GD con tirador en acero inoxidable (RV400IGD y FS400IGD).

Puerta de cristal con doble cristal en los modelos de refrigeración, triple cristal templado y calefactado en los modelos de baja temperatura.

Termostato digital.

Cerradura con llave de serie.

Iluminación Led en modelos con puerta de cristal.

BENEFITS

Models with blind door SD with integrated door handle (RV400ISD and FS400ISD) and models with glass door GD with handle in stainless steel (RV400IGD and FS400IGD).

Glass door with double glazing in the cooling models, triple tempered glass and heated in the low temperature models.

Digital thermostat.

Lock with serial key.

LED lighting in the models with glass door.

À SOULIGNER

Modèles avec porte pleine SD avec poignée intégrée dans la porte (RV400ISD et FS400ISD) et modèles avec porte vitrée GD avec poignée en acier inoxydable (RV400IGD et FS400IGD).

Porte avec double vitrage dans les modèles de réfrigération, triple vitrage avec verre trempé et chauffée dans les modèles à basse température.

Thermostat numérique.

Serrure avec clé de série.

Éclairage Led pour les modèles avec porte vitrée.



MODELO/MODELE/MODÈLE

RV 400 SD

RV 400 GD

FS 400 SD

FS 400 GD

| Precio Price Prix | 1.223 € | | 1.397 € | | 1.322 € | | 1.548 € | | |
|--|----------------|--------|--|---|----------------------|--|--|---|--|
| Medidas Measures Mesures | INT | ↔ ↕ | 600 685 1890 | 600 723 1890 | 600 685 1890 | 600 723 1890 | 600 723 1890 | 600 723 1890 | |
| Medidas Measures Mesures | EXT | ↔ ↕ | 480 540 1680 | 480 540 1680 | 470 533 1665 | 470 533 1665 | 470 533 1665 | 470 533 1665 | |
| Temperatura Temperature Température | [32°C] | | 2°C / +10°C | M1: -1°C / +5°C | -18°C / -22°C | -18°C / -22°C | L1: -15°C / -18°C | L1: -15°C / -18°C | |
| Tensión/Frecuencia Electrical data Tension électrique | [V/Hz] | | 230V / 50Hz | | | | | | |
| Material Material Matériel | | | Exterior en acero gris, puerta ciega Inox, puerta cristal con marco de aluminio, interior en termoconformado ABS. Exterior in steel grey, solid door Stainless steel, glass door aluminium frame, interior in ABS thermoformed. Extérieur en acier gris, porte aveugle en Inox, porte vitrée avec cadre en aluminium, intérieur thermoformé en ABS. | | | | | | |
| Capacidad Capacity Capacité | [L] | | 400 | | | | | | |
| Controlador Controller Régulateur | | | Digital | | | | | | |
| Iluminación Lighting Éclairage | | | No | Led horizontal parte superior / Top horizontal LED / Top horizontal LED | No | No | Led Vertical / Vertical LED / Led Verticale | Led Vertical / Vertical LED / Led Verticale | |
| Estantes Shelves Étagères | | | 4 Regulables/Adjustable/Réglable + 1 base | | | | 6 | | |
| Medidas estantes Shelves dimens. Mesures étagères | [mm] | | 6 [476x481x40] + 1 [476x292x40] | | | | Nivel del evaporador / Evaporator layer / Niveau de l'évaporateur 414x410 | | |
| Puerta Door Porte | | | Ciega / Solid | Cristal / Glass | Ciega / Solid | Ciega / Solid | Cristal / Glass | Cristal / Glass | |
| Condensación Condensation Condenseur | | | Estática / Static / Statique | | | | | | |
| Evaporación Evaporation Évaporateur | | | Ventilado / Ventilated / Ventilé Roll-bond | | | Estática / Static / Statique | | | |
| Desescarche Defrost Dégivrage | | | Automático / Automatic / Automatique | | | Manual/ Manual / Manuel | | | |
| Consumo Consumption Consommation | [Kwh/24h] | | 1,71 | 1,96 | 1,98 | 1,98 | 4,77 | 4,77 | |
| Potencia Power Puissance | [W] | | 200 | 200 | 400 | 400 | 450 | 450 | |
| Refrigerante Refrigerant Gaz | | | HC R600a | | | R290 | | | |
| Opcional Optional Options | | | - | | | Cestas / Baskets / Paniers 60mm [7Uds] 182 € | | | |

Serie / Series / Série **400L**

+Info: www.infrico.com

RV400SD



RV400GD



Cerradura
Door lock
Serrure



Control digital
Digital control
Contrôle digital



FS400SD



FS400GD



Congelador vertical / Freezer / Congélateur vertical

A DESTACAR

Aislamiento en poliuretano inyectado a alta presión [100% libre de CFC'S], con 55 mm de espesor.

Los modelos CV 130HC de serie con parrillas, el resto de modelos de serie con cajones extraíbles.

Panel de mandos [Termostato HC, piloto red, piloto alarma e interruptor congelación rápida].

BENEFITS

Injected polyurethane isolation to high pressure [100% free one of CFC'S], with 55 mm thickness.

Models CV 130 HC of the series with grills, the rest of models of series with removable drawers.

Control panel [Thermostat, pilot network, pilot alarm and fast freeze switch].

Á SOULIGNER

Isolation en polyuréthane injecté à haute pression [100% sans CFC'S], avec 55 mm d'épaisseur.

Les modèles CV 130 HC sont de série avec grilles, les autres modèles sont avec tiroirs amovibles de série.

Panneau de commande [Thermostat, réseau pilote, alarme pilote et interrupteur congélation rapide].

Dans des modèles CV 220 et CV 330 ouverture de porte 135° pour extraction tiroirs.

| MODELO/MODELE/MODÈLE | CV 130 HC CV 130 I HC | CV 220 HC | CV 330 HC |
|--|--|--|--|
| Precio Price Prix | 515 € 643 € | 637 € | 1.051 € |
| Medidas Measures [mm] Mesures | 540 600 870 | 540 600 1340 | 540 600 1920 |
| Tensión/Frecuencia Electrical data [V/Hz] Tension électrique | 220-240/50 | | |
| Material Material Matériel | Exterior chapa plastif. blanca [CV130IHC en chapa inox]. Interior termoconformado Exterior white plastic-coated sheet [CV130IHC in stainless steel inox]. Thermoformed interior Extérieur plastifié blanc [CV130IHC en tôle inox.] Intérieur thermoformé | | |
| Capacidad Capacity Capacité | 112 | 157 | 233 |
| Estantes Shelves Étagères | 3+1 | 7 | 9 [2 abatibles] |
| Temperatura Temperature [32°C] Température | -18°C / -23°C | | |
| Condensación Condensation Condenseur | Estática / Static / Statique | | |
| Evaporación Evaporation Évaporateur | Estática / Static / Statique | | |
| Desescarche Defrost [Kg.] Dégivrage | Manual/ Manual / Manuel | | |
| Compresor Compressor Compresseur | 1/9 | 1/6 | 1/9+1/8 |
| Potencia Power [W] Puissance | 80 | 110 | 80+100 |
| Capacid. congelación Freezing capacity [Kg/24h] Pouvoir congélation | 7 | 12 | 24 |
| Refrigerante Refrigerant Gaz | HC R600a | | |
| Opcional Optional Options | CV130 I HC 4 cajones / 4 drawers / 4 tiroirs: 663 € | Apertura puerta 135° para extracción de cajones. Door opening 135° for extraction of drawers. Ouverture de porte 135° pour extraction de tiroirs. | Chapa color inox. Plate color inox Tôle couleur inox. Apertura puerta 135° para extracción de cajones. Door opening 135° for extraction of drawers. Ouverture de porte 135° pour extraction de tiroirs. |

Serie / Series / Série **CV**

+Info: www.infrico.com



CV 130 INOX HC

Parrillas
Grills
Grilles



Cajones en opción
Drawers optional
Tiroirs en option

Puertas abatibles
Tilt forward doors
Portes battantes



CV 330 HC

[9 cajones]
[9 drawers]
[9 tiroirs]



CV 220 HC

[7 cajones]
[7 drawers]
[7 tiroirs]



Armario expositor heladería y pastelería / Exhibiting cupboard for ice-cream and pastry / Armoire d'exposition pour la glace et la pâtisserie

A DESTACAR

Exposición de 1 a 4 caras en cristal.
Estantes interiores en cristal de 530x450 mm [Mod. L03505, L03702, L07700].
Evaporador estático de 5 niveles en armarios heladería [L03500/3700/7703].
Estantes giratorios de diámetro 460 mm [Mod. L03701].
Ruedas en todos los modelos.
Iluminación interior LED.

BENEFITS

Four face glass exhibition.
Interior shelves in glass of 530x450 [Mod. L03505, L03702, Lo7700].
5-level static evaporator in ice cream cabinets [L03500/3700/7703].
Rotating shelved with a 460 diameter [Mod. Lo3701].
Castors in all of the models.
LED lighting.

À SOULIGNER

Quatre faces vitrées.
Étagères intérieures vitrées, 530x450mm [Mod. L03505, L03702, L07700].
Évaporateur statique à 5 niveaux dans les armoires à glace [L03500/3700/7703].
Étagères tournantes 460mm [Mod. Lo3701].
Roulettes sur tous les modèles.
Éclairage intérieur LED.

HELADERÍA / ICE-CREAM / GLACE



L03500



L03700

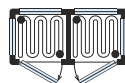

L07703



L03505



L03702



L03701

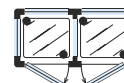

L07700

| MODELO/MODELE/MODÈLE | L03500 | L03700 | L07703 | L03505 | L03702 | L03701 | L07700 |
|---|--|--------------------|---|--------------------------------------|-----------------------------------|--|---|
| Precio Price Prix | 3.288 € | 4.278 € | 7.371 € | 3.048€ | 3.683 € | 4.023 € | 6.537 € |
| Medidas Measures (mm) Mesures | 700 650 1900 | 700 650 1900 | 1320 650 1900 | 700 650 1900 | 700 650 1900 | 700 650 1900 | 1320 650 1900 |
| Tensión/Frecuencia Electrical data [V/Hz] Tension électrique | 220/50 | | | | | | |
| Material Material Matériel | Estructura en aluminio anodizado con decoración de serie en Plata. Anodised aluminium structure with round forms, and with silver series decorations. Structure en aluminium anodisé avec décoration en argent de série. | | | | | | |
| Capacidad Capacity Capacité | 420 | 420 | 420+420 | 420 | 420 | 420 | 420+420 |
| Caras de cristal Glass sides Faces vitrées | 1 | 4 | 4 | 1 | 4 | 4 | 4 |
| Puertas Doors Portes | 1 | 1 | 2 | 1 | 1 | 1 | 2 |
| Estantes Shelves Étagères | 5 fijos + 1 móvil 5 fixed + 1 mobile 5 fixes + 1 amovible | | 5+5 fijos + 1+1 móvil 5+5 fixed + 1+1 mobile 5+5 fixes + 1+1 amovible | 5 móvil 5 mobile 5 amovible | 5 móvil 5 mobile 5 amovible | 6 giratorios 6 rotating 6 tournantes | 5+5 móvil 5+5 mobile 5+5 amovible |
| Temperatura Temperature (30°C) Température | -15°C / -24°C | | | +2°C / +10°C (40%-60% HR) | | | |
| Condensación Condensation Condenseur | Ventilada / Ventilated / Ventilée | | | | | | |
| Evaporación Evaporation Évaporateur | Estática / Static / Statique | | | | | | |
| Desescarche Defrost (Kg.) Dégivrage | Manual/ Manual / Manuel | | | Automático / Automatic / Automatique | | | |
| Compresor Compressor Compresseur | 1/2 | 1/2 | 1/2 + 1/2 | 1/4 | 1/4 | 1/4 | 1/4 + 1/4 |
| Potencia Power (W) Puissance | 471 | 511 | 942 | 365 | 365 | 395 | 730 |
| Refrigerante Refrigerant Gaz | R290 | | | | | | |
| Opcional Optional Options | Acabado blanco o negro / White or black finish / Finition noir ou blanc  Largo / wide / Longueur 700: 571 € Largo / wide / Longueur 1320: 666 € | | | | | | |

Serie / Series / Série **LO**

+Info: www.infrico.com

HELADERÍA / ICE-CREAM / GLACE



L03500



L03700

PASTELERÍA / PASTRY / PÂTISSERIE



L03702



L07700



Armario expositor SOFT AIR pastelería [opcional chocolate y bombones] / Exhibiting cupboard pastry SOFT AIR [chocolates optional] / Armoire d'exposition pâtisserie SOFT AIR [en option pour le chocolat et les bonbons]

Línea de vitrinas con refrigeración ventilada, con régimen de temperatura -2°C a +15°C.

5 Parrillas por puerta regulables en altura de medida 530x450mm, o estantes de cristal sin incremento de precio.

Estantes interiores en rejilla cromada de 530x450mm. [mod. L03905, L03902, L07900].

Estantes giratorios de 460mm de diámetro [Lo3901].

Iluminación interior LED.

Ruedas en todos los modelos.

Line of showcases with ventilated cooling, with temperature range -2°C to +15°C.

5 Shelves adjustable in height of measurement 530x450mm, or glass shelves without supplement.

Interior shelves in chrome grille 530x450mm. [mod. L03905, L03902, L07900].

Rotating shelves 460mm diameter [Lo3901].

Interior LED lightning.

Wheels on all models.

Ligne de vitrines à refroidissement ventilée, avec régime de température -2°C à +15°C.

5 Étagères réglables en hauteur, 530x450mm, ou étagères en verre sans frais supplémentaires.

Étagères intérieures en grille chromée 530x450mm. [mod. L03905, L03902, L07900].

Étagères rotatives de 460 mm de diamètre [Lo3901].

Éclairage LED intérieur.

Roulettes sur tous les modèles.



L03905



L03902



L03901

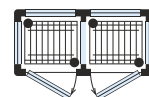

L07900

| MODELO/MODELE/MODÈLE | L03905 | L03902 | L03901 | L07900 |
|---|--|--------------------|---|---------------------|
| Precio Price Prix | 3.313 € | 4.093€ | 4.448€ | 7.136 € |
| Medidas Measures (mm) Mesures | 700 650 1900 | 700 650 1900 | 700 650 1900 | 1320 650 1900 |
| Tensión/Frecuencia Electrical data [V/Hz] Tension électrique | 220/50 | | | |
| Material Material Matériel | Estructura en aluminio anodizado con decoración de serie en Plata. Anodised aluminium structure with round forms, and with silver series decorations. Structure en aluminium anodisé avec décoration en argent de série. | | | |
| Capacidad Capacity Capacité | 420 | 420 | 420 | 420+420 |
| Caras de cristal Glass sides Faces vitrées | 1 | 4 | 4 | 4 |
| Puertas Doors Portes | 1 | 1 | 1 | 2 |
| Estantes Shelves Étagères | 5 | 5 | 6 giratorios 6 rotating 6 tournantes | 5+5 |
| Temperatura Temperature (30°C) Température | -2°C / +15°C | | | |
| Condensación Condensation Condenseur | Ventilada / Ventilated / Ventilée | | | |
| Evaporación Evaporation Évaporateur | Ventilada / Ventilated / Ventilée | | | |
| Desescarche Defrost (Kg.) Dégivrage | Automático / Automatic / Automatique | | | |
| Compresor Compressor (HP) Compresseur | 1/2 | 1/2 | 1/2 | 1/2 + 1/2 |
| Potencia Power (W) Puissance | 1014 | 1044 | 1074 | 1044+1044 |
| Refrigerante Refrigerant Gaz | R290 | | | |
| Opcional Optional Options | Opción chocolate y bombones / Chocolate option / Chocolate et bonbons en option Temp: +15°C / +18°C (40% / 60% HR) | | | |
| | 550 € | 550 € | 550 € | 550 € |
| | Opción quesos / Cheese option / Option fromages Consultar / To consult / Nous consulter | | | |
| | Acabado blanco o negro / White or black finish / Finition noir ou blanc | | | |
| | | | Largo / wide / Longueur 700: 571 € Largo / wide / Longueur 1320: 666 € | |

Serie / Series / Série **LO SOFT AIR**

+Info: www.infrico.com



L07900



L03902



Armario expositor heladería y pastelería (No-Frost) / Exhibiting cupboard for ice-cream and pastry (No-Frost) / Armoire d'exposition pour la glace et la pâtisserie (No-Frost)

A DESTACAR

Este sistema de refrigeración permite la inserción en la misma vitrina, tanto productos de pastelería como de heladería, simplemente regulando la temperatura del termostato.

Exposición desde 1 hasta 4 caras en cristal.

Organización interior compuesta de 5 parrillas por puerta, regulables en altura, excepto el Modelo LO 3701VNP con 6 estantes giratorios en cristal.

Estantes interiores en rejilla cromada de 530x450 mm. Estantes interiores en rejilla cromada de 730x450 mm. [ancho 900].

Estantes giratorios de diámetro 460 mm [Mod. LO3701VNP].

Ruedas en todos los modelos.

Iluminación interior LED.

BENEFITS

This refrigeration system allows insertion in the display of bakery products as well as ice cream, simply regulating the temperature of the thermostat.

Exhibit of 1 to 4 glass sides.

Interior organisation made up of 5 glass shelves by door, able to regulate in height, except Model LO 3701VNP with 6 rotating shelves in glass.

Interior shelves in chrome grill of 530x450 mm. Interior shelves in chrome grill of 730x450 mm. [width 900].

Rotating shelved with a 460 diameter [Mod. LO3701VNP].

Castors in all of the models.

LED lighting.

À SOULIGNER

Ce système permet d'utiliser l'armoire, à la fois, pour pâtisserie et glaces, en modifiant simplement la température du thermostat

Quatre faces vitrées.

5 grilles par porte, réglables en hauteur sauf modèle

LO3701VNP avec 6 étagères tournantes en verre.



Étagères intérieures chromées de 530x450mm.

Étagères intérieures chromées de 730x450mm. [largeur 900].

Étagères tournantes de 460 mm de diamètre [Mod. LO3701VNP].

Roulettes sur tous les modèles.

Éclairage intérieur LED.

| MODELO/MODELE/MODÈLE | LO3500VNP | LO3700VNP | LO3701VNP | LO7703VNP | LO9311VNP | LO9314VNP | LO9324VNP |
|---|--|--------------------|--|--|--------------------|--------------------|---------------------|
| Precio Price Prix | 4.148 € | 5.292 € | 5.647 € | 9.095 € | 5.212 € | 6.667 € | 11.514 € |
| Medidas Measures (mm) Mesures | 700 650 1900 | 700 650 1900 | 700 650 1900 | 1320 650 1900 | 900 650 1900 | 900 650 1900 | 1720 650 1900 |
| Tensión/Frecuencia Electrical data [V/Hz] Tension électrique | 220/50 | | | | | | |
| Material Material Matériel | Estructura en aluminio anodizado con decoración de serie en Plata. Anodised aluminium structure with round forms, and with silver series decorations. Structure en aluminium anodisé avec décoration en argent de série. | | | | | | |
| Capacidad Capacity Capacité | 420 | 420 | 420 | 420+420 | 600 | 600 | 600+600 |
| Caras de cristal Glass sides Faces vitrées | 1 | 4 | 4 | 4 | 1 | 4 | 4 |
| Puertas Doors Portes | 1 | 1 | 1 | 2 | 1 | 1 | 2 |
| Estantes Shelves Étagères | 5 | 5 | 6 giratorios 6 rotating 6 tournantes | 5+5 | 5 | 5 | 5+5 |
| Temperatura Temperature [30°C] Température | +5°C / -20°C | | | | | | |
| Condensación Condensation Condenseur | Ventilada / Ventilated / Ventilée | | | | | | |
| Evaporación Evaporation Évaporateur | Ventilada / Ventilated / Ventilée | | | | | | |
| Desescarche Defrost [Kg.] Dégivrage | Automático / Automatic / Automatique | | | | | | |
| Compresor Compressor Compresseur | 1 | 1 | 1 | 1+1 | 1 | 1 | 1+1 |
| Potencia Power [W] Puissance | 912 | 952 | 982 | 1824 | 865 | 905 | 1730 |
| Refrigerante Refrigerant Gaz | R290 | | | | | | |
| Opcional Optional Options | Acabado blanco o negro / White or black finish / Finition noir ou blanc  | | | Acabado blanco o negro / White or black finish / Finition noir ou blanc  | | | |
| | Largo / wide / Longueur 700: 571 € Largo / wide / Longueur 1320: 666 € | | | Largo / wide / Longueur 900: 762 € Largo / wide / Longueur 1720: 857 € | | | |

Serie / Series / Série **LO (No-Frost)**

+Info: www.infrico.com



LO 7703 VNP



LO 3500 VNP



L09324VNP



L09311VNP



Armario expositor para heladería / Exhibiting cupboard for ice-cream / Armoire d'exposition pour la glace

A DESTACAR

Sistema NO-FOG antiempañamiento en la puerta.
Iluminación con doble tira de LED con luz continua, mejora la visibilidad del producto expuesto.
Estantes no regulables en altura, con 4 niveles en el modelo [S] y 5 niveles en el modelo [L].
Disponible en 4 caras de cristal con terminación de serie en SILVER QUARTZ.

BENEFITS

NO-FOG anti-glare system on the door.
Double LED strip lighting with continuous light, improves the visibility of the exposed product.
Shelves not adjustable in height, with 4 levels in the model [S] and 5 levels in the model [L].
Available in 4 sides of glass with standard decoration in SILVER QUARTZ.

À SOULIGNER

Système NO-FOG dans les portes (Glaces et No-Frost).
Étagères non réglables en hauteur, 4 niveaux en modèle [S] et 5 niveaux en modèle [L].
Thermostat SOFT TOUCH avec écran graphique de 2.8" avec clavier tactile interactif.
Roulettes sur tous les modèles.
Quatre faces vitrées.
Finition standard SILVER QUARTZ.

| MODELO/MODELE/MODÈLE | L06114S | L06114L | L08114S | L08114L |
|---|--|-------------------------------|-------------------------------|-------------------------------|
| Precio Price Prix | 5.662 € | 6.231 € | 7.140 € | 7.927 € |
| Medidas Measures [mm] Mesures | 650 650 1500 | 650 650 1900 | 850 650 1500 | 850 650 1900 |
| Tensión/Frecuencia Electrical data [V/Hz] Tension électrique | 220/50 | | | |
| Material Material Matériel | Triple cristal sin perifería de aluminio, cristal exterior e interior bajo emisivo. Triple glass without aluminum profiles, exterior glass and low emissive interior. Triple vitrage avec verres à faible émissivité. | | | |
| Capacidad Capacity Capacité | 300 | 450 | 450 | 600 |
| Caras de cristal Glass sides Faces vitrées | 4 | 4 | 4 | 4 |
| Puertas Doors Portes | 1 | 1 | 1 | 1 |
| Estantes Shelves Étagères | 4 fijos 4 fixed 4 fixes | 5 fijos 5 fixed 5 fixes | 4 fijos 4 fixed 4 fixes | 5 fijos 5 fixed 5 fixes |
| Temperatura Temperature [30°C] Température | -15°C / -24°C | | | |
| Condensación Condensation Condenseur | Ventilada / Ventilated / Ventilée | | | |
| Evaporación Evaporation Évaporateur | Estática / Static / Statique | | | |
| Desescarche Defrost [Kg.] Dégivrage | Manual/ Manual / Manuel | | | |
| Potencia Power [W] Puissance | 501 | 719 | 632 | 829 |
| Refrigerante Refrigerant Gaz | R290 | | | |
| Opcional Optional Options | Acabado blanco o negro / White or black finish / Finition noir ou blanc  Mod. L650mm x H1500mm: 368 € Mod. L850mm x H1500mm: 484 € Mod. L650mm x H1900mm: 494 € Mod. L850mm x H1900mm: 610 € Modelos con 1,2,3 caras de cristal. Models 1,2,3 faces of glass. Modèles avec 1,2,3 faces vitrées. Barra iluminación LED adicional Additional LED strip Éclairage LED supplémentaire. Módulo para canalizar Modular model Module canalisable. | | | |

Serie / Series / Série **VITRA**

+Info: www.infrico.com



[850mm longitud,
altura 1900mm]
[850mm width,
height 1900mm]
[850mm longueur,
hauteur 1900mm]

Standard
[Silver quartz]

L08114L



[650mm longitud,
altura 1500mm]
[650mm width,
height 1500mm]
[650mm longueur,
hauteur 1500mm]

Standard
[Silver quartz]

L06114S



Blanco perla
White pearl
Blanc perle



Negro opal
Black opal
Noir opal



Termostato
Soft touch
Thermostat



Armario expositor para pastelería / Exhibiting cupboard for pastry / Armoire d'exposition pour pâtisserie

A DESTACAR

Iluminación con doble tira de LED con luz continua, mejora la visibilidad del producto expuesto.
Estantes de cristal regulables en altura de medida 510x450mm (mod. 650mm), y de medida 710x450mm (mod. 850mm).
3 niveles en el modelo S y 5 niveles en el modelo L. Modelo L06215S con 4 estantes de cristal giratorios.
Modelo L06215L con 6 estantes de cristal giratorios, diámetro del estante 460mm.
Disponible en 4 caras de cristal con terminación de serie en SILVER QUARTZ.

BENEFITS

Double LED strip lighting with continuous light, improves the visibility of the exposed product.
Glass shelves adjustable in height of measurement 510x450mm (mod. 650mm), and of measurement 710x450mm (mod. 850mm).
3 levels in model S and 5 levels in model L.
Model L06215S with 4 rotating glass shelves.
Model L06215L with 6 rotating glass shelves, shelf diameter 460mm.
Available in 4 sides of glass with standard decoration in SILVER QUARTZ.

À SOULIGNER

Étagères non réglables en hauteur, 4 niveaux en modèle [S] et 5 niveaux en modèle [L].
Étagères réglables en hauteur, 510x450mm (mod. 650), et 710x450 (mod. 850).
3 niveaux (mod. S), et 5 niveaux (mod. L).
Mod. L06215S avec 4 étagères tournantes en verre, et mod. L06215L avec 6 étagères tournantes en verre, 460mm Ø
Quatre faces vitrées et finition standard SILVER QUARTZ.

| MODELO/MODELE/MODÈLE | L06214S | L06214L | L06215S | L06215L | L08214S | L08214L |
|---|---|--------------------|--|--|--------------------|--------------------|
| Precio Price Prix | 5.170 € | 5.723 € | 5.635 € | 6.292 € | 6.209 € | 6.882 € |
| Medidas Measures [mm] Mesures | 650 650 1500 | 650 650 1900 | 650 650 1500 | 650 650 1900 | 850 650 1500 | 850 650 1900 |
| Tensión/Frecuencia Electrical data [V/Hz] Tension électrique | 220/50 | | | | | |
| Material Material Matériel | Triple cristal sin perifería de aluminio, cristal exterior e interior bajo emisivo. Triple glass without aluminum profiles, exterior glass and low emissive interior. Triple vitrage avec verres à faible émissivité. | | | | | |
| Capacidad Capacity Capacité | 300 | 450 | 300 | 450 | 450 | 600 |
| Caras de cristal Glass sides Faces vitrées | 4 | 4 | 4 | 4 | 4 | 4 |
| Puertas Doors Portes | 1 | 1 | 1 | 1 | 1 | 1 |
| Estantes Shelves Étagères | 3 | 5 | 4 giratorios 4 rotating 4 tournantes | 6 giratorios 6 rotating 6 tournantes | 3 | 5 |
| Temperatura Temperature [30°C] Température | +2°C / +10°C | | | | | |
| Condensación Condensation Condenseur | Ventilada / Ventilated / Ventilée | | | | | |
| Evaporación Evaporation Évaporateur | Estática / Static / Statique | | | | | |
| Desescarche Defrost [Kg.] Dégivrage | Automático / Automatic / Automatique | | | | | |
| Potencia Power [W] Puissance | 365 | 975 | 395 | 1005 | 365 | 975 |
| Refrigerante Refrigerant Gaz | R290 | | | | | |
| Opcional Optional Options | Acabado blanco o negro / White or black finish / Finition noir ou blanc <div style="display: flex; justify-content: center; gap: 20px;"> <div style="width: 20px; height: 20px; background-color: black; border: 1px solid black;"></div> <div style="width: 20px; height: 20px; background-color: white; border: 1px solid black;"></div> </div> Mod. L650mm x H1500mm: 368 € Mod. L650mm x H1900mm: 494 € Mod. L850mm x H1500mm: 484 € Mod. L850mm x H1900mm: 610 € | | | | | |

Serie / Series / Série **VITRA**

+Info: www.infrico.com

**(650mm longitud,
altura 1500mm)**
**(650mm width,
height 1500mm)**
**(650mm longueur,
hauteur 1500mm)**



L06215S



L06214L

**(650mm longitud,
altura 1900mm)**
**(650mm width,
height 1900mm)**
**(650mm longueur,
hauteur 1900mm)**



Armario expositor SOFT AIR pastelería [opcional chocolate y bombones] / Exhibiting cupboard pastry SOFT AIR [chocolates optional] / Armoire d'exposition pâtisserie SOFT AIR [en option pour le chocolat et les bonbons]

A DESTACAR

Línea de vitrinas con refrigeración ventilada, con régimen de temperatura -2°C a +15°C.

Estantes de cristal regulables en altura de medida 510x450mm, modelos de longitud 650mm y de medida 710x450mm, modelos de longitud 850mm, 3 niveles en el modelo "S" y 5 niveles en el modelo "L".

Disponible en 4 caras de cristal con terminación de serie en SILVER QUARTZ. Iluminación interior LED.

BENEFITS

Line of showcases with ventilated cooling, with temperature range -2°C to +15°C.

Glass shelves adjustable in height of measurement 510x450mm, models of length 650mm and of measurement 710x450mm, models of length 850mm, 3 levels in model "S" and 5 levels in model "L".

Available in 4 sides of glass with standard decoration in SILVER QUARTZ. Interior LED lightning.



À SOULIGNER

Ligne de vitrines à refroidissement ventilée, avec régime de température +15°C à +18°C.

Étagères réglables en hauteur, 510x450mm [mod. largeur 650], et 710x450 [mod. largeur 850]. 3 niveaux [mod. S], et 5 niveaux [mod. L].

Quatre faces vitrées et finition standard SILVER QUARTZ.

Éclairage LED intérieur.

| MODELO/MODELE/MODÈLE | L06414S | L06414L | L08414S | L08414L |
|---|--|--------------------|-------------------------------------|--------------------|
| Precio Price Prix | 5.684 € | 6.319 € | 6.839 € | 7.588 € |
| Medidas Measures (mm) Mesures | 650 650 1500 | 650 650 1900 | 850 650 1500 | 850 650 1900 |
| Tensión/Frecuencia Electrical data [V/Hz] Tension électrique | 220-240/50 | | | |
| Material Material Matériel | Triple cristal sin perifería de aluminio, cristal exterior e interior bajo emisivo. Triple glass without aluminum profiles, exterior glass and low emissive interior. Triple vitrage avec deux verres à faible émissivité. | | | |
| Capacidad Capacity Capacité | 300 | 450 | 450 | 600 |
| Caras de cristal Glass sides Faces vitrées | 4 | 4 | 4 | 4 |
| Puertas Doors Portes | 1 | 1 | 1 | 1 |
| Estantes Shelves Étagères | 3 | 5 | 3 | 5 |
| Temperatura Temperature (30°C) Température | -2°C / +15°C | | | |
| Condensación Condensation Condenseur | Ventilada / Ventilated / Ventilée | | | |
| Evaporación Evaporation Évaporateur | Ventilada / Ventilated / Ventilée SOFT AIR | | | |
| Desescarche Defrost (Kg.) Dégivrage | Automático / Automatic / Automatique | | | |
| Potencia Power (W) Puissance | 922 | 922 | 997 | 997 |
| Refrigerante Refrigerant Gaz | R290 | | | |
| Opcional Optional Options | Opción chocolate y bombones / Chocolate option / Chocolate et bonbons en option Temp: +15°C / +18°C (40% / 60% HR) | | | |
| | 559 € | 559 € | 559 € | 559 € |
| | Opción quesos / Cheese option / Option fromages Consultar / To consult / Nous consulter | | | |
| | Acabado blanco o negro / White or black finish / Finition noir ou blanc | | | |
| |  Mod. L650mm x H1500mm: 368 € | | Mod. L850mm x H1500mm: 489 € | |
| |  Mod. L650mm x H1900mm: 494 € | | Mod. L850mm x H1900mm: 610 € | |

Serie / Series / Série **VITRA SOFT AIR**

+Info: www.infrico.com

(650mm longitud,
altura 1900mm)
(650mm width,
height 1900mm)
(650mm longueur,
hauteur 1900mm)



L06414L



L08414L

(850mm longitud,
altura 1500mm)
(850mm width,
height 1500mm)
(850mm longueur,
hauteur 1500mm)



Armario expositor para heladería-pastelería NO-FROST / Exhibiting cupboard for ice-cream and pastry NO-FROST / Armoire d'exposition pour la glace et la pâtisserie NO-FROST

A DESTACAR

Fabricado en triple cristal sin perfilera de aluminio, cristal exterior e interior bajo emisivo.
Sistema NO-FOG antiempañamiento en la puerta.
Iluminación con doble tira de LED con luz continua, mejora la visibilidad del producto expuesto.
Estantes de cristal regulables en altura de medida 510x450mm [mod. 650mm], y de medida 710x450mm [mod. 850mm].
3 niveles en el modelo S y 5 niveles en el modelo L.
Modelo L06315S con 4 estantes de cristal giratorios.
Modelo L06315L con 6 estantes de cristal giratorios, diámetro del estante 460mm.
Disponible en 4 caras de cristal con terminación de serie en SILVER QUARTZ.

BENEFITS

Made of triple glass without aluminum profiles, exterior glass and low emissive interior.
NO-FOG anti-glare system on the door.
Double LED strip lighting with continuous light, improves the visibility of the exposed product.
Glass shelves adjustable in height of measurement 510x450mm [mod. 650mm], and of measurement 710x450mm [mod. 850mm].
3 levels in model S and 5 levels in model L.
Model L06315S with 4 rotating glass shelves.
Model L06315L with 6 rotating glass shelves, shelf diameter 460mm.
Available in 4 sides of glass with standard decoration in SILVER QUARTZ.

À SOULIGNER

Fabriquée en triple vitrage avec deux verres à faible émissivité.
Système NO-FOG dans les portes.
Étagères non réglables en hauteur, 4 niveaux en modèle [S] et 5 niveaux en modèle [L].
Étagères réglables en hauteur, 510x450mm [mod. 650], et 710x450 [mod. 850].
3 niveaux [mod. S], et 5 niveaux [mod. L].
Mod. L06315S avec 4 étagères tournantes en verre, et mod. L06315L avec 6 étagères tournantes en verre, 460mm Ø
Quatre faces vitrées et finition standard SILVER QUARTZ.

| MODELO/MODELE/MODÈLE | L06314S | L06314L | L06315S | L06315L | L08314S | L08314L |
|---|---|--------------------|--|--|--------------------|--------------------|
| Precio Price Prix | 6.948 € | 7.654 € | 7.358 € | 8.206 € | 8.743 € | 9.399 € |
| Medidas Measures [mm] Mesures | 650 650 1500 | 650 650 1900 | 650 650 1500 | 650 650 1900 | 850 650 1500 | 850 650 1900 |
| Tensión/Frecuencia Electrical data [V/Hz] Tension électrique | 220/50 | | | | | |
| Material Material Matériel | Triple cristal sin perfilera de aluminio, cristal exterior e interior bajo emisivo. Triple glass without aluminum profiles, exterior glass and low emissive interior. Triple vitrage avec deux verres à faible émissivité. | | | | | |
| Capacidad Capacity Capacité | 300 | 450 | 300 | 450 | 450 | 600 |
| Caras de cristal Glass sides Faces vitrées | 4 | 4 | 4 | 4 | 4 | 4 |
| Puertas Doors Portes | 1 | 1 | 1 | 1 | 1 | 1 |
| Estantes Shelves Étagères | 3 | 5 | 4 giratorios 4 rotating 4 tournantes | 6 giratorios 6 rotating 6 tournantes | 3 | 5 |
| Temperatura Temperature [30°C] Température | +5°C / -20°C | | | | | |
| Condensación Condensation Condenseur | Ventilada / Ventilated / Ventilée | | | | | |
| Evaporación Evaporation Évaporateur | Ventilada / Ventilated / Ventilée | | | | | |
| Desescarche Defrost [Kg.] Dégivrage | Automático / Automatic / Automatique | | | | | |
| Potencia Power [W] Puissance | 833 | 997 | 863 | 1027 | 991 | 1415 |
| Refrigerante Refrigerant Gaz | R290 | | | | | |
| Opcional Optional Options | Acabado blanco o negro / White or black finish / Finition noir ou blanc <div style="display: flex; justify-content: center; gap: 10px;"> <div style="width: 20px; height: 20px; background-color: black; border: 1px solid black;"></div> <div style="width: 20px; height: 20px; background-color: white; border: 1px solid black;"></div> </div> Mod. L650mm x H1500mm: 368 € Mod. L650mm x H1900mm: 494 € Mod. L850mm x H1500mm: 484 € Mod. L850mm x H1900mm: 610 € | | | | | |

Serie / Series / Série **VITRA NO-FROST**

+Info: www.infrico.com

(650mm longitud,
altura 1900mm)
(650mm width,
height 1900mm)
(650mm longueur,
hauteur 1900mm)

Negro/Black/Noir
Opcional
Optional
Option



L06314L

(650mm longitud,
altura 1900mm)
(650mm width,
height 1900mm)
(650mm longueur,
hauteur 1900mm)



L06314L



Murales calientes / Hot display cabinet / Murale d'exposition chaude

A DESTACAR

Tecnología de doble recuperación y circulación del aire caliente para un correcto mantenimiento de los productos envasados.

Sistema de cortina de aire caliente en el frontal así como en cada balda que dispone de una regulación y ventilación del aire caliente.

Costados laterales panorámicos con efecto espejo.

Tope de fijación del cristal frontal templado en cada estante para evitar la caída del producto.

Facilidad de desplazamiento al disponer de 4 ruedas, dos con freno.

Termostato digital regulable entre 20°C a 90°C para el mantenimiento del producto a temperatura reglamentaria de 63°C al corazón del producto. Norma HACCP.

Iluminación mediante tubo led en la parte posterior a ambos lados.

HDC60L: 5 Niveles de exposición en INOX [4 estantes + cuba] no regulables en altura e inclinación con superficie de exposición 580x480mm.

HDC100S: 3 Niveles de exposición en INOX [2 estantes + cuba] no regulables en altura e inclinación con superficie de exposición 980x480mm.

HDC100L: 5 Niveles de exposición en INOX [4 estantes + cuba] no regulables en altura e inclinación con superficie de exposición 980x480mm.

BENEFITS

Double recovery technology and hot air circulation for a correct maintenance of the packaged products.

Hot air curtain system on the front, as well as on each shelf, with hot air regulation and ventilation.

Panoramic side panels with mirror effect.

Tempered front glass fixing stop on each shelf to prevent the product from falling.

Easy to move as it has 4 castors, two with brakes.

Digital thermostat adjustable from 20°C to 90°C to maintain the product at the regulatory temperature of 63°C at the heart of the product. HACCP Standard.

Illumination by LED tube at the back on both sides.

HDC60L: 5 stainless steel display levels (4 shelves + tank) not adjustable in height and inclination with display surface 580x480mm.

HDC100S: 3 stainless steel display levels (2 shelves + tank) not adjustable in height and inclination with display surface 980x480mm.

HDC100L: 5 stainless steel display levels (4 shelves + tank) not adjustable in height and inclination with a 980x480mm display surface.

Á SOULIGNER

Double technologie de récupération et circulation d'air chaud pour un entretien correct des produits emballés.

Système de rideau d'air chaud à l'avant, ainsi que sur chaque étagère, avec régulation et ventilation de l'air chaud.

Panneaux latéraux panoramiques avec effet miroir.

Butée de fixation en verre trempé sur chaque étagère pour empêcher le produit de tomber.

Facile à déplacer car il possède 4 roues, dont deux avec freins.

Thermostat numérique réglable de 20°C à 90°C pour maintenir le produit à la température réglementaire de 63°C au cœur du produit. Norme HACCP.

Illumination par tube LED à l'arrière, sur les deux côtés.

HDC60L : 5 niveaux d'affichage INOX [4 étagères + réservoir] non réglables en hauteur et en inclinaison avec une surface d'affichage de 580x480mm.

HDC100S : 3 niveaux d'affichage INOX [2 étagères + réservoir] non réglables en hauteur et en inclinaison avec surface d'affichage 980x480mm.

HDC100L : 5 niveaux d'affichage INOX [4 étagères + réservoir] non réglables en hauteur et en inclinaison avec surface d'affichage 980x480mm.



HDC 60 L



HDC 100 S



HDC 100 L

| MODELO/MODELE/MODÈLE | HDC 60 L | HDC 100 S | HDC 100 L |
|---|---|-------------------------|-------------------------|
| Precio Price Prix | 10.868 € | 11.337 € | 13.041 € |
| Medidas Measures [mm] Mesures | 604 x 812 x 1973 | 1005 x 812 x 1529 | 1005 x 790 x 1970 |
| Temperatura Temperature Température | +63°C | | |
| Tensión/Frecuencia Electrical data Tension électrique | 230/1ph/20A | 400/3ph/9A | 400/3ph/21A |
| Material Material Matériel | Exterior: acero lacado negro / Interior: acero Inox / Trasera: Inox sin puerta Exterior: black lacquered stainless / Interior: stainless steel / Back: stainless steel without door. Extérieur: acier laqué noir / Intérieur: acier inox / Arrière: acier inox sans porte | | |
| Niveles de exposición Exposure levels Niveaux d'exposition | 5 | 3 | 5 |
| Iluminación Lighting Éclairage | Barras laterales en Led / Led sidebars / Barres laterales Led | | |
| Control temperatura Temp. control Contrôle de la températ. | Digital | | |
| Consumo instantáneo Instant. consumption Consommation instant. | 4,5 | 6,3 | 8,3 |
| Consumo medio Average consumption Consommation moyenne | 2,3 | 3,1 | 4,1 |
| Opcional Optional Options | Opción 60Hz | | 408 € |

Serie / Series / Série **HDC**

HDC 100 L



HDC 100 S



Doble recuperación y circulación del aire caliente
 Double recovery technology and hot air circulation
 Double technologie de récupération et circulation d'air chaud

Doble iluminación lateral LED
 LED light at the back on both sides

Double éclairage LED à l'arrière, sur les deux côtés



HDC 60 L



Carros calientes de distribución / Heated banquet trolleys / Chariot distributeur maintien au chaud



HT1021



HT1021



HT2021



HT4021

MODELO/MODELE/MODÈLE

| | HT1021 | HT2021 | HT4021 |
|--|--|----------------------|----------------------------|
| Precio Price Prix | 2.417 € | 2.947 € | 4.976 € |
| Medidas Measures [mm] Mesures | 910 827 1160 | 910 827 1816 | 910 1517 1816 |
| Tensión/Frecuencia Electrical data [V/Hz] Tension électrique | 230V/50-60Hz | | |
| Material Material Matériel | Ext: Chapa galvanizada plastificada blanco / Galvanised steel white plastic coated / Tôle galvanisée plastifiée blanc. Int: Cuba interior en aluminio / Aluminium inner tank / Cuve intérieure en aluminium | | |
| Capacidad Capacity Capacité [L] | 310 | 550 | 1300 |
| Nº Guías Nº Slides Nº Guides | 5 GN2/1 | 11 GN2/1 22 GN1/1 | 11+11 GN2/1 22+22 GN1/1 |
| Puerta Door Porte | 1 puerta ciega abatible 270º apertura 1 hinged blind door, 270º opening 1 porte aveugle, battant 270º | | |
| Temperatura Temperature [32°C] Température | +50°C / +80°C | | |
| Distancia entre bandejas Distance between trays Distance entre bacs | 57mm | | |
| Cajón calefactor Heating drawer Tiroir chauffant | Extraíble con resistencia y depósito de agua Removable with heating element and water tank Amovible avec élément chauffant et réservoir d'eau | | |
| Vapor Steam Vapeur | No | | |
| Control digital Digital control Contrôle numérique | Temperatura / Alarmas HACCP Temperature / HACCP Alarms Température / Alarmes HACCP | | |
| Potencia Power Puissance [W] | 2.000 | | |
| Opcional Optional Options | Parrillas / Grills / Grilles | | |

osmarc.es
NEW

Serie / Series / Série **HT**



HT2021



HT4021



Horno microondas profesional / Professional microwave oven / Four micro-ondes professionnel

A DESTACAR

Capacidad útil 34L. Para bandejas GN 2/3 y platos de gran diámetro.

HM1001M: Dispone de dial temporizador electrónico con función AutoReset, manual sin programas. 5 niveles de potencia. Guía de menú para elementos de uso frecuente.

HM1401P / HM1802P: Modelos digitales de membrana táctil. Funcionamiento manual o con programas. 5 niveles de potencia y 3 etapas de cocción. Tiempo de cocción máximo de 60 minutos y 100 programas automáticos. Opción de ingreso de tiempo y botón de cantidad múltiple x2 que permite cocinar diferentes porciones.

HM1001M y **HM1401P** con magnetrón y antena giratoria inferior.

HM1802P con dos magnetrones, dos antenas giratorias inferior y superior. Iluminación de la cámara. Señal acústica de final de ciclo de cocción. Posibilidad de montaje apilado de dos microondas [x2].

Filtro de aire en la parte frontal.

BENEFITS

Useful capacity 34L. GN 2/3 trays or large diameter plates.

HM1001M: 6 minute electronic timer dial with AutoReset function, manual without programs. 5 power levels by turning the dial counterclockwise. Menu guide for frequently used items.

HM1401P / HM1802P: Digital models of touch membrane. Manual operation or with programs. 5 power levels and three cooking stages. Maximum cooking time of 60 minutes and 100 automatic programs. Time entry option and multiple quantity button x2 that allows cooking different portions.

HM1001M / HM1401P with a magnetron, with a lower rotating antenna.

HM1802P with two magnetrons, with two lower and upper rotating antennas. Camera lighting. Acoustic signal at the end of the cooking cycle. Possibility of stacking two microwaves [x2]. Front air filter.

À SOULIGNER

Capacité utile 34L. Plateaux GN 2/3 ou des plaques de grand diamètre.

HM1001M: minuterie électronique, 6 minutes avec AutoReset, manuel sans programmes. 5 niveaux de puissance. Notice des différents menus pour les éléments les plus fréquemment utilisés.

HM1401P/HM1802P: Mod. numériques à membrane tactile à fonctionnement manuel ou programmable. 5 niveaux de puissance, 3 niveaux de cuisson. Temps de cuisson maximum de 60 minutes et 100 programmes automatiques. Option: saisie du temps et bouton qui multiplie par 2 la quantité permettant de cuire différentes portions.

HM1001M/HM1401P avec magnétron et antenne rotative inférieure.

HM1802P Deux magnétrons, deux antennes rotatives inférieures et supérieures. Eclairage intérieur. Alarme de fin de cycle. Possibilité de superposer 2 micro-ondes. Filtre à air frontal.

| MODELO/MODELE/MODÈLE | HM1001M | HM1401P | HM1802P |
|---|--|---|---|
| Precio Price Prix | 580 € | 809 € | 1.080 € |
| Medidas Measures [mm] Mesures | EXT: 553x488(494)x343 INT: 370x385x230 | EXT: 553x488(494)x343 INT: 370x385x230 | EXT: 574x528(535)x368 INT: 360x409x225 |
| Tensión/Frecuencia Electrical data [V/Hz] Tension électrique | 220/50 | | |
| Material Material Matériel | Ext/Int: acero inoxidable Ext/Int: stainless steel Ext/Int: acier inoxydable | | |
| Magnetrones Magnetrons Magnétrons | 1 | 1 | 2 |
| Niveles potencia Power levels Niveaux de puissance | 5 | 5 | 5 |
| Etapas de cocción Cooking stages Étapes de la cuisson | 1 | 3 | 3 |
| Tipo de control Control type Type de contrôle | Dial / Dial / Cadran | Membrana Táctil /Tactil membrane / Membrane tactile | |
| Descongel. por tiempo Defrosting by time Dégivrage par le temps | No | Sí/Yes/Oui | |
| Opción ingreso tiempo Time input option Option de saisi des temps | Sí/Yes/Oui | | |
| Máx. tiempo cocción Max. cooking time [min] Temps cuisson max. | 6 | 60 | |
| Ajuste porción múltiple Multiple portion settings Possibilité plusieurs portions | No | Sí/Yes/Oui x 2 | |
| Ajuste porción múltiple Multiple portion settings Possibilité plusieurs portions | Tiempo/Time/Temps | Tiempo-Programas/Time-Programs/Temps-Programmes | |
| Función cocción express Express cooking function Fonction cuisson express | Sí/Yes/Oui | | |
| Potencia Power Puissance [W] | 1000 | 1400 | 1800 |
| Consumo Consumption Consommation [W] | 1600 | 1900 | 2800 |
| Opcional Optional Options | - | | |

Serie / Series / Série **MICROONDAS**

+Info: www.infrico.com



HM1001M



HM1401P

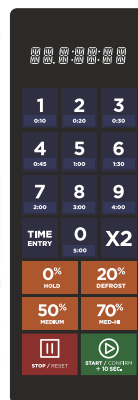

HM1802P

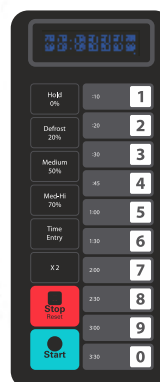

Horno eléctrico para panadería / Electric bakery oven / Fours pour la boulangerie

Serie / Series / Série **HE**

Armario caliente fermentador / Fermentation ovens / Armoire de fermentation

Serie / Series / Série **FERMENTADOR**

A DESTACAR (HE)

Puerta con doble cristal serigrafiado en color gris con tirador y apertura batiente.
Termostato seguridad.
Iluminación interior.

BENEFITS (HE)

Double glass door with grey stamped color and integrated handle.
Security thermostat.
Interior lighting.

À SOULIGNER (HE)

Porte avec double vitrage sérigraphié en gris avec poignée et ouverture à charnière.
Thermostat de sécurité.
Éclairage intérieur.

A DESTACAR (FERMENTADOR)

Puerta abatible de cristal.
Recipiente disponible para depositar agua y aportar humedad.

BENEFITS (FERMENTADOR)

Self-closing glass door.
Available water deposit and humidity kit.

À SOULIGNER (FERMENTADOR)

Porte battante en verre.
Récipient disponible pour déposer de l'eau et fournir de l'humidité.



HE304

HE424



F 848

HORNOS HE

FERMENTADOR

| MODELO/MODELE/MODÈLE | HE304 | HE424 | HE424G | F848 |
|---|---|---|---|---------------------------------------|
| Precio Price Prix | 879 € | 927 € | 1.388 € | 1.185 € |
| Medidas Measures [mm] Mesures | EXT: 590x675x540 INT: 450x340x345 | EXT: 640x720x540 INT: 500x410x345 | EXT: 640x720x540 INT: 500x410x345 | 640 640 975 |
| Tensión/Frecuencia Electrical data [V/Hz] Tension électrique | 230V-50-60Hz | | | |
| Material Material Matériel | Ext/Int: acero inoxidable Ext/Int: stainless steel Ext/Int: acier inoxydable | | | |
| Temperatura Temperature Température | +50°C / +250°C | | | 30°C / +85°C |
| Capacidad Capacity Capacité | 4 bandejas/trays/bacs 430x340 4GN2/3 | 4 parrillas/shelves/grilles 480x340 4GN2/3 | 4 parrillas/shelves/grilles 480x340 4GN2/3 | 8 trays 480x340 |
| Grill Electrical Grill Grill | - | - | Serie/Series/Série | - |
| Kit bandejas GN GN Trays kit Kit bacs GN | Serie/Series/Série | | | - |
| Espacio entre bandejas Shelves distance Espace entre les grilles | 80 mm | | | - |
| Temporizador Timer Minuterie | 0-120 min. Modo continuo / Continuous mode / Mode continu Alarma fin de ciclo / Cycle alarm / Alarme pour fin de cycle | | | - |
| Motor Engine Moteur | 2 | | | - |
| Potencia Power Puissance | 3100W | 3100W | 3100W | 700 |
| Opcional Optional Options | Apertura puerta lateral / Door side opening / Ouverture porte latérale | | | Consultar/To consult/Consulter |
| | Humidificador / Humidity kit / Humidificateur | | | 134 € |
| | Soporte horno HE424 [8 guías] / Hold up over HE424 [8 slides] / Support four HE424 [8 glissières] | | | 465 € |

Horno eléctrico para panadería 600x400 / Electric bakery oven 600x400/Fours pour la boulangerie 600x400

Armario caliente fermentador / Fermentation ovens / Armoire de fermentation

Serie / Series / Série HE 600x400

Serie / Series / Série FERMENTADOR

A DESTACAR (HE 600x400)

Puerta con doble cristal serigrafiado en color gris con tirador y apertura batiente. Termostato seguridad. Iluminación interior. Micro de puerta (en modelos HE604/604PLUS/HE604PLUSG).

BENEFITS (HE 600x400)

Double glass door with grey stamped color and integrated handle. Security thermostat. Interior lighting. Micro Switch on the door (modelos HE604/HE604PLUS/ HE604PLUSG).

À SOULIGNER (HE 600x400)

Porte avec double vitrage sérigraphié en gris avec poignée et ouverture à charnière. Thermostat de sécurité. Éclairage intérieur. Microrupteur sur la porte (modèles HE604/HE604PLUS/HE604PLUSG).

A DESTACAR (FERMENTADOR)

Puerta abatible de cristal. Recipiente disponible para depositar agua y aportar humedad.

BENEFITS (FERMENTADOR)

Self-closing glass door. Availabel water deposit and humidity kit.

À SOULIGNER (FERMENTADOR)

Porte battante en verre. Récipient disponible pour déposer de l'eau et fournir de l'humidité.

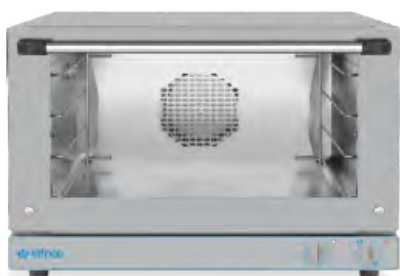

HE604



HE604PLUS

HORNOS HE 600x400



F 860

FERMENTADOR

| MODELO/MODELE/MODÈLE | HE603 | HE604 | HE604PLUS | HE604PLUSG | F860 |
|---|---|---|---|---|---------------------|
| Precio Price Prix | 1.460 € | 1.678 € | 1.975 € | 2.489 € | 1.315 € |
| Medidas Measures (mm) Mesures | EXT: 760x800x465 INT: 620x450x270 | EXT: 760x800x545 INT: 620x450x350 | EXT: 760x800x545 INT: 620x450x350 | EXT: 760x800x545 INT: 620x450x350 | 820 700 975 |
| Tensión/Frecuencia Electrical data (V/Hz) Tension électrique | 230V-50-60Hz | 400/230V-50-60Hz | | | 230V-50-60Hz |
| Material Matériel | Ext/Int: acero inoxidable Ext/Int: stainless steel Ext/Int: acier inoxydable | | | | |
| Temperatura Temperature Temperature | +50°C / +250°C | | | | 30°C / +85°C |
| Capacidad Capacity Capacité | 3 parrillas/shelves/grilles (600x400) | 4 parrillas/shelves/grilles (600x400) 4GN 1/1 | 4 parrillas/shelves/grilles (600x400) 4GN 1/1 | 4 parrillas/shelves/grilles (600x400) 4GN 1/1 | 8 trays 600x400 |
| Grill Electrical Grill Grill | - | - | - | Serie/Series/Série | - |
| Kit bandejas GN GN Trays kit Kit bacs GN | - | Serie/Series/Série | | | - |
| Espacio entre bandejas Shelves distance Espace entre les grilles | 80 mm | | | | - |
| Temporizador Timer Minuterie | 0-120 min. Modo continuo / Continuous mode / Mode continu Alarma fin de ciclo / Cycle alarm / Alarme pour fin de cycle | | | | - |
| Motor Engine Moteur | 1 | | 2 | | - |
| Potencia Power Puissance | [W] 3900W | 5700W | 6300W | 6300W | 1400 |
| Opcional Optional Options | Apertura puerta lateral / Door side opening / Ouverture porte latérale | | Consultar/To consult/Consulter | | - |
| | Humidificador / Humidity kit / Humidificateur | | 134 € | | - |
| | Soporte horno HE603/604/604PLUS / Hold up over HE603/604/604PLUS / Support four HE603/604/604PLUS | | 664 € | | - |



Invasadora al vacío de aspiración externa / External aspiration vacuum packaging machine / Machine sous vide à aspiration extérieure.

Serie / Series / Série **VACE**

A DESTACAR

Bomba auto-lubricante.

Panel de mandos digital con tres programas establecidos, proceso de embasado automático controlado electrónicamente.

Tiempo de vacío regulable, establecido a 15 y 30 segundos con posibilidad de regularlo manualmente.

Tiempo de soldadura ajustable de 1 a 7 segundos.

Vac stop permite parar en cualquier momento una fase del proceso pasando a la siguiente.

Funciona con bolsas gofradas.

BENEFITS

Self-lubricating pump.

3 programs set, automatic vacuum process controlled.

Removable vacuum time, set from 15 to 30 seconds with manual remove possibility.

Vac stop allow stop the machine in time phase of the processes.

Embossed bags.

À SOULIGNER

Pompe auto lubrifiante.

Commande digitale avec 3 programmes.

Contrôle sous vide automatique, réglé à 15 et 30 secondes avec possibilité de réglage manuel.

Temps de soudure réglable de 1 à 7 secondes.

Vac stop permet d'arrêter à tout moment une phase du processus en passant à la suivante.

Il fonctionne avec des sacs gofrés.

VACE30



VACE40

Panel de mandos digital
Digital control
Tableau de bord digital

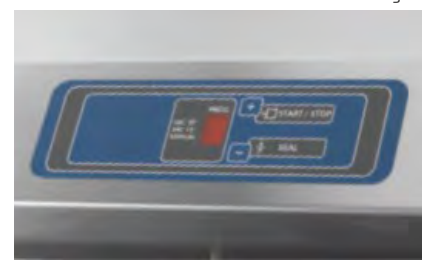

| MODELO/MODELE/MODÈLE | VACE30 | VACE40 |
|---|--|--------------|
| Precio Price Prix | 653 € | 968 € |
| Medidas Measures [mm] Mesures | 385x254x125 | 485x254x125 |
| Tensión/Frecuencia Electrical data [V/Hz] Tension électrique | 220-230/50-60Hz | |
| Material Material Matériel | Ext/Int: acero inoxidable AISI 304 Ext/Int: stainless steel AISI 304 Ext/Int: acier inoxydable AISI 304 | |
| Capacidad bomba Bomb capacity Pompe à vide | 20 | 40 |
| Longitud soldadura Welding wide Barre de soudure | 300 | 400 |
| Bolsa Bag Sac | Gofrada / Embossed / Gaufré | |
| Potencia Power [W] Puissance | 270 | 450 |
| Opcional Optional Options | - | |

Máquina termoselladora / Thermosealer machine / Machines thermo-soudeuses

Serie / Series / Série TSB

A DESTACAR

Sellado y corte simultaneo del film.
Sistema de frenado de retroceso del film, facilitando la colocación de las barquetas.

Modelo TSB150 incluye dos moldes:

- 1 molde para una barqueta 192x137 mm.
- 1 molde para dos barquetas 96x137 mm.

Modelo TSB 290 incluye dos moldes:

- 1 molde para una barqueta 1/2 GN [320x265 mm].
- 1 molde para dos barquetas 1/4 GN [265x162 mm].

El molde para dos barquetas esta provisto de una guía central para facilitar el corte del film.

Se suministra con bobina de film de de 300 metros de longitud y 150 mm de ancho [TSB150].

TSB290 no incluye bobina.

Profundidad máxima de la barqueta 100 mm.

BENEFITS

Cutting and welding simultaneous.
Stopping system of film regression helping the positioning.

Model TSB150 includes:

- 1 mold for 1 tank 192x137 mm.
- 1 mold for 2 tanks 96x137 mm.

Model TSB150 includes:

- 1 mold for 1 tank 1/2 GN [192x137 mm].
- 1 mold for 2 tanks 1/4 GN [265x162 mm].

The mold provide with a centred guide to help cutting the film.

Provided with Roll 300 m long and 150 mm width [TSB150].

TSB290 without roll.

Maximum depth 100 mm.

À SOULIGNER

Soudure et découpes simultanées.

Système de frein et retour du film.

Modèle TSB150 comprend:

- 1 Moule de dimensions de 192x137 mm.
- 1 Moule de dimensions de 96x 137 mm.

Modèle TSB290 comprend:

- 1 Moule pour barquettes 1/2 GN [320x265 mm].
- 1 Moule pour barquettes 1/4 GN [265x162 mm]

Le moule pour deux barquettes est équipé d'une glissière centrale pour faciliter la découpe du film.

Il est livré sur une bobine de film de 300 mètres de long et 150 mm de large [TSB150].

Le TSB290 n'a de bobine.

Profondeur maximale de la barquette: 100mm.



Bobina de film y dos moldes de serie

Film roll and two standard moulds

Bobine de film et deux moules de série

TSB150



TSB290

| MODELO/MODELE/MODÈLE | TSB150 | TSB290 |
|---|--|---|
| Precio Price Prix | 1.085 € | 2.313€ |
| Medidas Measures [mm] Mesures | 230x500x180 | 380x650x180 |
| Tensión/Frecuencia Electrical data [V/Hz] Tension électrique | 220-230/50-60Hz | |
| Material Material Matériel | Ext/Int: acero inoxidable AISI 304 Ext/Int: stainless steel AISI 304 Ext/Int: acier inoxydable AISI 304 | |
| Ancho bobina Roll width Largeur bobine | 150 | 200 |
| Potencia Power [W] Puissance | 400 | 1400 |
| Opcional Optional Options | [TSB 150] Bobina de longitud 150 m y ancho 150 mm Provide with Roll 150 m long and 150 mm Bobine de longueur 150 mm et largeur 150 mm. 65 € | [TSB 290] Bobina de longitud 200 m y ancho 280 mm Roll 200 m of lenght and 280 mm Bobine de longueur 200 mm et largeur 280 mm. 115 € |



Invasadora al vacío [Tiempo] / Vacuum packaging machine [Time] / Machine sous vide [Temps]

Serie / Series / Série **VACT**

A DESTACAR

Vacuometro [excepto Mod. VACT6A]. Regulación tiempo de vacío. Regulación tiempo de soldadura. Entrada de atmósfera progresiva. Stop Vacío. Indicador luminoso del proceso activo. Modelos de sobremesa Bomba DVP de alto rendimiento. Modelos de pie Bomba Busch.

BENEFITS

Vacuum meter [except Mod. VACT6A]. Vacuum gauge time control. Sealing time control. Progressive atmosphere entry. Stop vacuum. Lighting alarm of active process. DVP pump high performance. BUSCH pump in the stand models.

À SOULIGNER

Vacuomètre [sauf mod. VACT6A]. Réglage temps sous vide. Réglage temps de soudure. Entrée d'atmosphère progressive. Arrêt sous vide. Indicateur lumineux du processus actif. Modèles à poser Pompe DVP haute performance. Modèles sur pieds avec pompe Busch.



VACT 6A



VACT 8A



VACT 12A / VACT 20A

Cuba embutida
Stamped pan
Cuve emboutie



Tapa metacrilato transparente con bisagras en acero inox
Transparent methacrylate lid with stainless steel hinges.

Couvercle transparent en méthacrylate avec charnières en inox



| MODELO/MODELE/MODÈLE | MODELOS SOBREMESA / DESLTOP MODELS / MODÈLES À POSER | | | | | | MOD. DE PIE / FLOOR MOD. / MOD. SUR PIED | | |
|--|--|----------------------------|----------------------------|----------------------------|----------------------------|----------------------------|--|-----------------------------|------------------------------|
| | VACT6A | VACT8A | VACT12A | VACT20A | VACT20B | VACT20BB | VACT40AB | VACT63AB | VACT100AB |
| Posición barra soldadura Sealing bar position Position barre de soudure | | | | | | | | | |
| Precio Price Prix | 2.572 € | 2.942 € | 3.216 € | 3.385 € | 3.887 € | 4.238 € | 8.814 € | 9.192 € | 11.425 € |
| Medidas EXT. ↔ Measures INT. ↓ Mesures | 340x480x325 280x355x90 | 410x455x360 350x350x120 | 480x560x440 450x420x180 | 480x560x440 450x420x180 | 610x575x440 550x470x180 | 610x575x440 550x470x180 | 800x575x1040 680x470x200 | 800x575x1040 680x470x200 | 1000x705x1040 880x600x200 |
| Tensión/Frecuencia Electrical data [V/Hz] Tension électrique | 220-230/50-60 | | | | | | 400/50-60 | | |
| Material Material Matériel | Ext/Int: acero inoxidable AISI 304 / Tapa metacrilato Ext/Int: stainless steel AISI 304 / Methacrylate lid Ext/Int: acier inoxydable AISI 304 / Couvercle méthacrylate | | | | | | | | |
| Capacidad bomba Bomb capacity Pompe à vide | 6m ³ DVP | 8m ³ DVP | 12m ³ DVP | 20m ³ DVP | 20m ³ DVP | 20m ³ DVP | 40m ³ BUSCH | 63m ³ BUSCH | 100m ³ BUSCH |
| Longitud soldadura Welding wide Barre de soudure | 270 | 340 | 410 | 410 | 450 | 450 | 580+450 | 580+450 | 780+580 |
| Nº Barras soldadura N. welding bars Nº barres de soudure | 1 | | | | | | 2 | | |
| Potencia Power Puissance (W) | 260 | 350 | 540 | 750 | 750 | 750 | 1120 | 1500 | 2250 |
| Opcional Optional Options | - | | | | | | | | |

Envasadora al vacío (Sensor) / Vacuum packaging machine (Sensor) / Machine sous vide (Capteur)

Serie / Series / Série VACS

A DESTACAR

50 programas. Regulación porcentual de vacío. Tiempo extra de vacío. Entrada gas inerte regulable porcentualmente. Tiempo de soldadura. Entrada de atmósfera progresiva. Programa especial para el sistema Gastro vac en los modelos de Sobremesa con Bomba DVP. Stop Vacío. Auto-calibración. Bomba Busch de alto rendimiento en modelos con pre-bomba. Entrada Gas inerte de serie. Auto-clean oil, sistema de autolimpieza del aceite de la bomba.

BENEFITS

50 programmes. Vacuum percentage control. Additional extra vacuum time. Gas entry percentage control. Sealing time control. Special gastro vac programme in with DVP pump. Stop vacuum. High performance BUSH pump in model with pump pre-install. Inert gas standard. Pre-Install gastro vac system for external countriners vacuum. Self-calibration for a perfect vacuum, providing atmosphere presion.

À SOULIGNER

50 programmes. Réglage partiel du sous vide. Temps extra du sous vide. Temps de soudure. Entrée d'atmosphère progressive. Programme spécial pour le système gastro-vac. Arrêt sous vide avec DVP. Auto-calibrage. Pompe Busch haute performance sur les modèles pré-installé. Système gastro vac pré-installé faire le vide extérieur dans des récipients Gastronorm pour les modèles à poser. Huile auto-nettoyante, système auto-nettoyant pour huile de pompe.



Barra soldadura sin conexiones con doble soldadura

Welding bar without connections and double welding

Barre de soudure sans connexion (double barres)



VACS 8A



VACS 20BB



VACS 63AB



MODELOS SOBREMESA / DESLTOP MODELS / MODÈLES À POSER

MOD. DE PIE / FLOOR MOD. / MOD. SUR PIED

Posición barra soldadura
Sealing bar position
Position barre de soudure



MODELO/MODELE/MODÈLE

VACS8A

VACS10A

VACS20A

VACS20B

VACS20BB

VACS40AB

VACS63AB

VACS100AB

| Precio Price Prix | 3.124 € | 3.397 € | 3.584 € | 4.538 € | 4.763 € | 9.027 € | 9.403 € | 11.635 € |
|--|---|----------------------------|----------------------------|----------------------------|----------------------------|-----------------------------|-----------------------------|------------------------------|
| Medidas Measures Mesures | EXT. 410x455x360 INT. 350x350x120 | 480x560x440 450x420x180 | 480x560x440 450x420x180 | 610x575x440 550x470x180 | 610x575x440 550x470x180 | 800x575x1040 680x470x200 | 800x575x1040 680x470x200 | 1000x705x1040 880x600x200 |
| Tensión/Frecuencia Electrical data [V/Hz] Tension électrique | 220-230/50-60 | | | | | 400/50-60 | | |
| Material Material Matériel | Ext/Int: acero inoxidable AISI 304 / Tapa metacrilato Ext/Int: stainless steel AISI 304 / Methacrylate lid Ext/Int: acier inoxydable AISI 304 / Couverture méthacrylate | | | | | | | |
| Capacidad bomba Bomb capacity Pompe à vide | 8m ³ DVP | 10m ³ DVP | 20m ³ DVP | 20m ³ DVP | 20m ³ DVP | 40m ³ BUSCH | 63m ³ BUSCH | 100m ³ BUSCH |
| Longitud soldadura Welding wide Barre de soudure | 340 | 410 | 410 | 450 | 450 | 580+450 | 580+450 | 780+580 |
| Nº Barras soldadura N. welding bars Nº barres de soudure | 1 | | | | 2 | | | |
| Potencia Power Puissance | [W] 440 | 540 | 750 | 750 | 750 | 1120 | 1500 | 2250 |
| Opcional Optional Options | Gastro VAC 115 € | | | | | | | |



Plancha a gas / Gas griddles / Plancha à gaz

Serie / Series / Série **PG**

A DESTACAR

PV:

Encendido con piezo eléctrico. Quemador en forma de herradura con doble salida de llama, logrando una temperatura uniforme en toda la placa. Orificio dispuesto en la placa con cajón recogedor de grasas integrado en el frontal. Válvulas de gas con dos intensidades de calor, máximo y mínimo. Toma de gas por el lateral izquierdo o derecho. Pies regulables en altura.

NS/NC:

Encendido tren de chispas a batería. Quemador en forma de herradura con doble salida de llama, logrando una temperatura uniforme en toda la placa. Orificio dispuesto en la placa con cajón recogedor de grasas integrado en el frontal. Válvulas de gas con dos intensidades de calor, máximo y mínimo [serie NS] y válvula de gas termostática con regulación de 100°C a 300°C. [serie Cromo duro]. Entrada de gas por la parte trasera derecha, liberando los laterales de conexiones externas. Pies regulables en altura.

BENEFITS

PV:

Electric piezo ignition. Burner with double exit flame, obtaining a uniform temperature for controlled cooking. Gas valves with two intensities of heat, maximum and minimum. Gas connection at left or right hand side. Adjustable legs. Hole in the plate with integrated grease trap drawer on the front.

NS/NC:

Ignition by sparks to battery. Burner with double exit flame, obtaining a uniform temperature for controlled cooking. Intergrated fat collection drawer in the front. Gas valves with two intensities of heat, maximum and minimum [serie NS] and thermostatic gas valves with regulation from 100°C to 300°C [serie Chromo duro]. Gas connection at the back. Adjustable feet.

À SOULIGNER

PV:

Allumage électrique. Brûleur en forme de fer à cheval avec double sortie de flamme, pour obtenir une température uniforme sur toute la plaque. Tiroir récupérateur de graisses installé en partie frontale. Valves de gaz avec deux intensités de chaleur, maximum et minimum. Entrée de gaz sur le côté gauche ou droit. Pieds réglables en hauteur.

NS/NC:

Allumage par étincelles. Brûleur en forme de fer à cheval avec double sortie de flamme, pour obtenir une température uniforme sur toute la plaque. Tiroir récupérateur de graisses installé en partie frontale. Valves de gaz avec deux intensités de chaleur, maximum et minimum [série NS] et valve de gaz thermostatique réglable de 100° à 300°C [série chrome dur]. Entrée du gaz à l'arrière droit laissant libre deux côtés externes pour les connexions. Pieds réglables en hauteur.



| MODELO/MODELE/MODÈLE | PG45PV | PG60PV | PG75PV | PG90PV | PG60NS | PG80NS | PG100NS | PG60NC | PG80NC | PG100NC |
|--|---|-------------------|-------------------|-------------------|--|-------------------|--------------------|--|-------------------|--------------------|
| Precio Price Prix | 471 € | 611 € | 637 € | 779 € | 895 € | 1.085 € | 1.347 € | 1.455 € | 1.815 € | 2.082 € |
| Medidas Measures Mesures | EXT. ↔ 460 INT. ↓ 435 190 | 610 435 190 | 760 435 190 | 910 435 190 | 600 440 180 | 800 440 180 | 1000 440 180 | 600 440 180 | 800 440 180 | 1000 440 180 |
| Material Material Matériel | Placa acero pavonado 6mm, negro Treated stainless steel plate 6 mm, black Chrome plate 15 mm, welded splashback | | | | Placa acero laminado 15mm, peto perimetral inox Laminated steel plate 15 mm, welded splashback Chrome plate 15 mm, welded splashback | | | Placa en cromo duro 15mm, peto perimetral inox Chrome plate 15 mm, welded splashback Chrome plate 15 mm, welded splashback | | |
| Kcal/h | 3526 | 7052 | 7482 | 10922 | 7052 | 10578 | 12814 | 7052 | 10578 | 12814 |
| Nº quemadores Nº of burners Nº brûleurs | 1 | 2 | 2 | 3 | 2 | 3 | 3 | 2 | 3 | 3 |
| Nº válvulas Nº of valves Nº valves | 1 | 2 | 2 | 3 | 2 | 3 | 3 | 2 | 3 | 3 |
| Superficie útil Usable area Surface utile | 440x390 | 590x390 | 740x390 | 890x390 | 595x430 | 795x430 | 995x430 | 595x430 | 795x430 | 995x430 |
| Potencia Power Puissance | (W) 4100 | 8200 | 8700 | 12700 | 8200 | 12300 | 14900 | 8200 | 12300 | 14900 |
| Opcional Optional Options | - | | | | | | | | | |

Plancha eléctrica / Electrical griddles / Plancha électrique

Serie / Series / Série PE

A DESTACAR

Resistencias blindadas de acero inoxidable.
Orificio dispuesto en la placa con cajón recogedor de grasas integrado en el frontal.
Termostatos con conmutador incorporado con variación de temperatura entre 50°C y 300°C.
Pies regulables en altura.

BENEFITS

Heater elements plated in stainless steel.
Intergrated fat collection drawer in the front.
Thermostat with variation of teempearture from 50°C to 300°C.
Adjustable feet.

Á SOULIGNER

Résistances blindées en acier inoxydable.
Tiroir récupérateur de graisses installé en partie frontale.
Thermostats avec commutateur incorporé qui permet une variation entre 50° et 300°C.
Pieds réglables en hauteur.



| MODELO/MODELE/MODÈLE | PE60PV | PE75PV | PE60NS | PE80NS | PE60NC | PE80NC |
|--|--|-------------------|---|-------------------|---|-------------------|
| Precio Price Prix | 720 € | 733 € | 1.030 € | 1.260 € | 1.535 € | 1.900 € |
| Medidas EXT. ↔ Measures Mesures INT. ↓ | 610 435 190 | 760 435 190 | 600 435 180 | 800 435 180 | 600 435 180 | 800 435 180 |
| Material Material Matériel | Placa acero pavonado 6mm, negro Treated stainless steel plate 6 mm, black Chrome plate 15 mm, welded splashback | | Placa acero laminado 15mm, peto perimetral inox Laminated steel plate 15 mm, welded splashback Chrome plate 15 mm, welded splashback | | Placa en cromo duro 15mm, peto perimetral inox Chrome plate 15 mm, welded splashback Chrome plate 15 mm, welded splashback | |
| Nº quemadores Nº of burners Nº brûleurs | 2 | 2 | 2 | 3 | 2 | 3 |
| Nº válvulas Nº of valves Nº valves | 2 | 2 | 2 | 3 | 2 | 3 |
| Superficie útil Usable area Surface utile | 590x390 | 740x390 | 595x430 | 795x430 | 595x430 | 795x430 |
| Potencia Power Puissance | [W] 4000 | 4000 | 4000 | 5300 | 4000 | 5300 |
| Opcional Optional Options | - | | | | | |



Grill eléctrico / Electrical grill / Grille panini électrique

Serie / Series / Série **GR**

A DESTACAR

Todas las placas superiores son acanaladas, excepto los modelos "TL" que son lisas.
Termostato independiente regulable hasta 250°C.
Termostato de seguridad.
Señalizador luminoso, que se apaga cuando la placa ha alcanzado la temperatura deseada.
Recogedor grasas frontal.

BENEFITS

All superior plates are grooved, except the models "TL" who are smooth.
Adjustable thermostat at 250°C.
Safety thermostat.
Pilot light which turns off when reaching the desired temperature.
Frontal greases collector.

À SOULIGNER

Toutes les plaques supérieures sont rainurées, sauf les modèles "TL" qui sont lisses.
Thermostat indépendant réglable jusqu'à 250°C.
Thermostat de sécurité.
Signal lumineux, qui s'éteint quand la plaque a atteint la température souhaitée.
Tiroir récupérateur de graisses en position frontale.



GR 42



GR 82

| MODELO/MODELE/MODÈLE | GR 42 | GR 41 L | GR 41 LTL | GR 61 | GR 61 L | GR 61 LTL | GR 82 | GR 82 L | GR 82 LTL | GR M2 |
|--|--|-------------------------|-------------------------|-------------------------|-------------------------|-------------------------|-------------------------|-------------------------|-------------------------|-------------------------|
| Precio Price Prix | 484 € | 484 € | 484 € | 564 € | 564 € | 564 € | 817 € | 817 € | 817 € | 817 € |
| Medidas Measures (mm) Mesures | ↔ 400 ↗ 430 ↓ 240 | ↔ 400 ↗ 430 ↓ 240 | ↔ 400 ↗ 430 ↓ 240 | ↔ 510 ↗ 430 ↓ 240 | ↔ 510 ↗ 430 ↓ 240 | ↔ 510 ↗ 430 ↓ 240 | ↔ 690 ↗ 430 ↓ 240 | ↔ 690 ↗ 430 ↓ 240 | ↔ 690 ↗ 430 ↓ 240 | ↔ 690 ↗ 430 ↓ 240 |
| Tensión/Frecuencia Power supply [V/Hz] Tension/Fréquence | 230/50-60 | | | | | | | | | |
| Superf. placa inferior Surface low plate Surface plaque inférieur | 255 x 245 | | | 365 x 245 | | | 550 x 245 | | | |
| Temperatura Temperature [°C] Température | +30°C / +250°C | | | | | | | | | |
| Material Material Matériel | Estructura en acero inoxidable / Placas acanaladas o lisas de hierro fundido Stainless steel body / Flat or grooved iron plates Structure en acier inoxydable / Plaques rainurées ou lisses en fonte | | | | | | | | | |
| Potencia Power Puissance (W) | 1800 | 1800 | 1800 | 3000 | 3000 | 3000 | 3600 | 3600 | 3600 | 3600 |
| Opcional Optional Options | - | | | | | | | | | |

Freidora eléctrica / Electrical fryer / Friteuse électrique

Serie / Series / Série FR

A DESTACAR

Resistencias blindadas de acero inoxidable.
Cabezal desmontable para facilitar la limpieza de la cuba.
En los modelos con grifo, cubeta con fondo inclinado para su perfecto vaciado.
Grifo de media pulgada de paso total.
Termostato regulable hasta 195°C.
Termostato de seguridad en todos los modelos.

BENEFITS

Heater covered by stainless steel.
Lift out control panel for easy cleaning.
Models with tap are equipped with slanting tank for easy empty.
Tap 1/2".
Adjustable thermostat at 195°C.
Safety thermostat in all models.

À SOULIGNER

Résistances blindées en acier inoxydable.
Tête détachable pour un nettoyage facile du réservoir.
Pour les modèles avec robinet, cuve à fond incliné pour une vidange parfaite.
Robinet d'un demi pouce de passage total.
Thermostat réglable jusqu'à 195 ° C.
Thermostat de sécurité sur tous les modèles.



| MODELO/MODELE/MODÈLE | FR 6L | FR 66L | FR 8L G | FR 88L G | FR 10L G | FR 1010L G | FR 10L GT | FR 1010L GT |
|---|---|-------------------|-------------------|-------------------|-------------------|-------------------|-------------------|-------------------|
| Precio Price Prix | 343 € | 597 € | 445 € | 843 € | 566 € | 1.051 € | 645 € | 1.238 € |
| Medidas Measures (mm) Mesures | 260 355 320 | 520 355 320 | 260 395 315 | 520 395 315 | 260 445 315 | 520 445 315 | 260 445 315 | 520 445 315 |
| Tensión/Frecuencia Power supply (V/Hz) Tension/Fréquence | 230/50 | | | | | | 400+N/50 | |
| Material Material Matériel | Estructura en acero inoxidable Stainless steel body Structure en acier inoxydable | | | | | | | |
| Capacidad (Aceite) Capacity (Oil) Capacité (Huile) | 6 | 6+6 | 8 | 8+8 | 10 | 10+10 | 10 | 10+10 |
| Grifo Tap Robinet | No / No / Non | | | Sí / Yes / Oui | | | | |
| Cesta Basket Panier | 210x210x100 | 210x210x100 | 220x240x100 | 220x240x100 | 220x280x100 | 220x280x100 | 220x280x100 | 220x280x100 |
| Nº cestas Nº baskets Nº paniers | 1 | 2 | 1 | 2 | 1 | 2 | 1 | 2 |
| Potencia Power Puissance | 3000 | 3000x2 | 3500 | 3500x2 | 4500 | 4500x2 | 6000 | 6000x2 |



Salamandra / Salamander / Salamandre

A DESTACAR

Las salamandras completan con eficacia y en poco espacio el equipamiento de cualquier cocina, desde el snack bar hasta la restauración colectiva, tanto con menús de carne como de pescado.

Resultan indispensables en locales pequeños que sirven tapas o pinchos, como bares con almuerzos ligeros, mesas calientes, comida rápida y bocaterías, así como en las cocinas de los chefs más exigentes, que cuidan cada detalle de sus platos y preparados.



Gratinar verduras, patatas y hortalizas. Ultimar platos al horno como lasañas, canelones y pasteles salados... Mantener calientes platos listos para servir.



Gratinate vegetables, potatoes and vegetables. Finishing baked dishes such as lasagne, cannelloni and savoury pies... Keeping ready-to-serve dishes warm.



Gratiner des légumes, des pommes de terre. Finir des plats au four tels que lasagnes, cannellonis, flans, quiches... Maintenir à température des plats prêts à servir à table.



Gratinar pescados, moluscos y crustáceos. Asar a la parrilla o acabar de hacer carnes: hamburguesas, bistecs, salchichas y milanesas... Caramelizar y ultimar postres.



Gratinating fish, molluscs and crustaceans. Grilling or finishing meats: hamburgers, steaks, sausages and breaded meats... Caramelising and finishing desserts.



Gratiner le poisson, les mollusques, les crustacés. Griller ou finir la viande: hamburger, steaks, wurstel, côtelettes... Caraméliser et finir les desserts.

BENEFITS

Salamanders are an efficient and space-saving addition to any kitchen, from snack bars to catering establishments, for both meat and fish menus.

They are indispensable in small establishments serving tapas or pinchos, such as light lunch bars, hot tables, fast food and snack bars, as well as in the kitchens of the most demanding chefs, who take care of every detail of their dishes and preparations.

Á SOULIGNER

Les salamandres complètent de manière efficace et peu encombrante toutes les cuisines, des snack-bars aux établissements de restauration, pour les menus de viande et de poisson.

Elles sont indispensables dans les petits locaux servant des tapas ou des pinchos, tels que les bars à repas légers, les tables chaudes, les fast-foods et les snack-bars, ainsi que dans les cuisines des chefs les plus exigeants, qui soignent chaque détail de leurs plats et de leurs préparations.



BASIC



CLÁSICA /
CLASSIC /
CLASIQUE



| | BASIC | | | CLÁSICA / CLASSIC / CLASIQUE | | | |
|---|-------------------------|-------------------|-------------------|------------------------------------|---------------------|-------------------------|-------------------|
| MODELO/MODELE/MODÈLE | SE 40 BM | SE 60 BM | SE 60 BT | SE 40 M | SE 60 M | SE 60 T | SE 80 T |
| Precio Price Prix | 1.736 € | 1.883 € | 1.883 € | 2.132 € | 2.387 € | 2.387 € | 3.098 € |
| Medidas Measures [mm] Mesures | ↔ 400 ↗ 450 ↓ 500 | 600 450 500 | 600 450 500 | 400 548 500 | 600 548 500 | 600 548 500 | 800 548 500 |
| Tensión/Frecuencia Power supply [V/Hz] Tension/Fréquence | 220-240/50-60HZ | 220-240/50-60HZ | 400 2N/50-60HZ | 220-240/ 50-60HZ | 220-240/ 50-60HZ | 380-415 3N / 50-60HZ | 400 3N / 50-60HZ |
| Potencia Power Puissance | 2 | 4 | 4 | 2 | 4 | 4 | 6 |

Serie / Series / Série **SALAMANDRA**

+Info: www.infrico.com



**ULTRA-RÁPIDA /
ULTRARAPID /
ULTRA-RAPIDE**

Resistencias infrarrojas.
20" para alcanzar la temperatura máxima, 5" estando en funcionamiento.
Excelente uniformidad de cocción.
2 zonas de cocción independientes (mod. 60), y seleccionables completas o individuales.

Infrared heaters.
20" to reach maximum temperature, 5" in operation.
Excellent cooking uniformity.
2 independent cooking zones (mod. 60), selectable full or individual.

Résistances à infrarouges.
20" pour atteindre la température maximale à partir de la mise en marche, 5" en cours de fonctionnement.
Parfaite uniformité de cuisson.
2 zones de cuisson indépendantes (mod. 60), sélectionnables comme complètes ou individuelles.



NEW

**ULTRA-RÁPIDA CONTACT /
ULTRARAPID CONTACT /
ULTRA-RAPIDE CONTACT**



Función de contacto: barra de detección de placa.
Contact function: plate detection bar.
Fonction de contact : barre de détection des plaques.



**GAS /
GAS /
GAZ**



| MODELO/MODELE/MODÈLE | ULTRA-RÁPIDA / ULTRARAPID / ULTRA-RAPIDE | | | NEW | ULTRA-RÁPIDA CONTACT / ULTRARAPID CONTACT / ULTRA-RAPIDE CONTACT | | | GAS / GAS / GAZ |
|--|--|-------------------|-------------------------|-------------------|--|-------------------------|-------------------|-----------------------|
| | SEUF 40 M | SEUF 60 M | SEUF 60 T | SEUF 40 M | SEUF 60 M | SEUF 60 T | SG 4 | |
| Precio Price Prix | 2.750 € | 3.081 € | 3.081 € | 2.997 € | 3.350 € | 3.3502 € | 2.138 € | |
| Medidas Measures Mesures | ↔ 400 ↗ 548 ↓ 500 | 600 548 500 | 600 548 500 | 400 548 500 | 600 548 500 | 600 548 500 | 750 400 460 | |
| Tensión/Frecuencia Power supply Tension/Fréquence | 220-240/50-60HZ | | 380-415 3N / 50-60HZ | 220-240/50-60HZ | | 380-415 3N / 50-60HZ | | |
| Potencia Power Puissance | 2 | 4 | 4 | 2 | 4 | 4 | 7,4 | |



Tostador de túnel eléctrico / Electric tunnel toaster / Toaster à tunnel électrique

Serie / Series / Série **TTV/TTH**

A DESTACAR

Modelo TTH3000, apto para tostar, gratinar o calentar.
Modelo TTV2400 y TTV4000, apto para tostar.
Resistencias blindadas.
Selector cuatro posiciones.
Regulador velocidad cinta.
Cajón recogemigas.

BENEFITS

Model TTH3000 for toasting, browning and heating.
Model TTV2400 and TTV4000 for toasting.
Recovered heater elements on model.
Selector four positions.
Adjustable speed of the band.
Crumbs drawer.

À SOULIGNER

Modèle TTH3000, adapté pour griller, gratiner ou réchauffer.
Modèle TTV2400 et TTV4000, adapté pour grâter.
Résistances blindées.
Sélecteur quatre positions.
Régulateur vitesse de tapis.
Tiroir ramasse-miettes.



TTV4000



TTV2400



TTH3000

| MODELO/MODELE/MODÈLE | TTV2400 | TTH3000 | TTV4000 |
|---|---|-------------------|-------------------|
| Precio Price Prix | 1.275 € | 1.316 € | 1.556 € |
| Medidas Measures [mm] Mesures | 480 510 410 | 750 420 250 | 570 620 400 |
| Tensión/Frecuencia Power supply [V/Hz] Tension/Fréquence | 230/50-60 | | 400/ 230/50-60 |
| Material Material Matériel | Estructura en acero inoxidable Stainless steel body Structure en acier inoxydable | | |
| Nº resistencias Nº heater elements Nº brûleurs | 2 | 2 | 2 |
| Ancho de cinta Wide of band Largueur du tapis | 260 | 200 | 360 |
| Altura entrada alimentos Height of opening Hauteur entrée des aliments | 70 | 70 | 70 |
| Potencia Power Puissance [W] | 1400+1400 | 1500+1500 | 2000+2000 |
| Opcional Optional Options | - | | |

Tostador eléctrico / Electrical toaster / Toaster électrique

Serie / Series / Série T

A DESTACAR

E: Temporizador regulable 15 minutos, en los modelos T6ECT y T12ECT.

Los modelos sin temporizador T6EST y T12EST, cuentan con interruptores independientes para cada nivel de resistencias.

Dos resistencias por planta, protegidas por tubo de cuarzo de material atóxico.

Cajón recogemigas.

T6/T12:

Temporizador regulable 15 minutos.

Interruptores independientes para cada nivel de resistencias.

Tres resistencias por planta, protegidas por tubo de cuarzo de material atóxico.

Cajón recogemigas.

BENEFITS

E: Adjustable time setting up to 15 minutes, the model T6ECT y T12ECT.

Models without time setting T6EST and T12EST, have independant switches for each heater zone.

Two heater elements for each zone, quartz recovered.

Crumbs drawer.

T6/T12:

Adjustable time setting up to 15 minutes.

Independent switches for each heater zone.

Three heater elements for each zone, quartz recovered.

Crumbs drawer.

À SOULIGNER

E: Temporisateur réglable 15 minutes. Deux résistances par niveau, protégées par un tube en quartz non toxique. Tiroir ramasse-miettes.

T6/T12:

Les modèles sans temporisateur ont des interrupteurs indépendants pour chaque niveau de résistances.

Deux résistances par niveau, protégées par un tube en quartz non toxique.

Tiroir ramasse-miettes.



T6E CT



T6



T12

| MODELO/MODELE/MODELE | T6E ST | T12E ST | T6E CT | T12E CT | T6 | T12 |
|---|---|-------------------|-------------------|-------------------|-------------------|-------------------|
| Precio Price Prix | 255 € | 322 € | 272 € | 339€ | 314 € | 410 € |
| Medidas Measures [mm] Mesures | 480 260 240 | 480 260 370 | 480 260 240 | 480 260 370 | 525 305 325 | 525 305 445 |
| Tensión/Frecuencia Power supply [V/Hz] Tension/Fréquence | 230/50 | | | | 230/50-60 | |
| Material Material Matériel | Estructura en acero inoxidable Stainless steel body Structure en acier inoxydable | | | | | |
| Nº resistencias Nº heater elements Nº resistance | 4 | 6 | 4 | 6 | 6 | 9 |
| Temporizador Timer Temporisateur | No / No / Non | | | Sí / Yes / Oui | | |
| Nº interruptores Nº switches Nº d'interrupteurs | 2 | 3 | 0 | 1 | 2 | 3 |
| Potencia Power Puissance [W] | 2000 | 3000 | 2000 | 3000 | 2000 | 2750 |
| Opcional Optional Options | - | | | | | |



Termo de leche / Milk urns / Termo de lait

Serie / Series / Série TL

A DESTACAR

Calentador al baño María, ideal para leche, café, consomé, té, etc.
Deposito en acero inox desmontable mediante rosca.
Termostato autorregulable.
Interruptor luminoso puesta en marcha.
Grifo regulable en dos posiciones.

BENEFITS

Bain Marie heating, ideal for milk, coffee, consomme, tea, etc.
Deposit in detachable steel inox by means of spiral.
Self-regulatory thermostat.
Beginning luminous switch.
Adjustable faucet in two positions.

À SOULIGNER

Mise en température par bain-marie, idéal pour lait, café, consommé, thé, etc.
Réservoir en acier inox démontable (système à vissees).
Thermostat autoréglable.
Interrupteur lumineux mise en marche.
Robinet réglable dans deux positions.



TL 6



TL 66

| MODELO/MODELE/MODÈLE | TL 3 | TL 6 | TL 66 |
|---|---|-------------------|-------------------|
| Precio Price Prix | 659 € | 684 € | 1.257 € |
| Medidas Measures [mm] Mesures | 232 232 430 | 265 265 525 | 525 265 525 |
| Tensión/Frecuencia Power supply [V/Hz] Tension/Fréquence | 220-230/50 | | |
| Material Material Matériel | Int/Ext: acero inoxidable AISI 304 Int/Ext: Stainless steel AISI 304 Int/Ext: acier inoxydable AISI 304 | | |
| Capacidad Capacity Capacité | 3 [L] | 6 | 6+6 |
| Potencia Power Puissance | 1000 [W] | 1500 | 1500 +1500 |
| Opcional Optional Options | Sujeción tapa para uso como termo de chocolate. Attachment covers for use like chocolate thermus. Fixation du couvercle pour utilisation comme thermos à chocolat. | | |

Cortadora de fiambre / Sharpening slicers / Trancheuse professionnelle

Serie / Series / Série CS / CSCEV

A DESTACAR

Avance del producto por gravedad.
Motor ventilado profesional de transmisión por correa.
Cuchilla rectificada y cromada en cromo duro.
Espesor máximo de corte 14 - 16 mm.
Afilador fijo en la gama "S".
Interruptor marcha-paro con relé, que no permite, en caso de interrupción de la corriente, el funcionamiento de la máquina sin el rearme del mismo [GAMA SCEV].
Fácil limpieza de todos sus componentes.

BENEFITS

Professional ventilated motor.
Tempered ground hard chromium-plate professional blade.
Slizing thickness up to 14 - 16 mm.
Fixed sharpener in range "S".
Start and stop switch with relay to avoid the automatic restarting of the machine in the case of electrical power shortage [RANGE SCEV].
Easy cleaning of all components.

Á SOULIGNER

Avancée du produit par gravité.
Moteur ventilé professionnel avec transmission par courroie.
Lame concave.
Épaisseur maximale de coupe 14 - 17 mm.
Rémouleur fixe dans la gamme "S".
Interrupteur marche-arrêt avec un relais qui ne permet pas, en cas de coupure de courant, le fonctionnement de la machine sans reprogrammation [SCEV].
Nettoyage facile de tous ses composants.



C220 SCEV



C250 S



C300 SCEV



C 350 SCEV

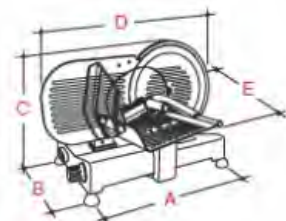

Afilador con doble esmeril.
Sharpener with double emery
Rémouleur avec double émeri.



Modelo SCEV con bloqueo de carro deslizante que permite desmontar la bandeja de alimentos y su cojinete.

Model SCEV with block of sliding carriage which allows to disassemble the food tray and its bearing
Modèle SCEV avec verrouillage du chariot coulissant qui permet de démonter le plateau à aliments et son roulement.



Prensa producto con protección en plexiglas

Food-holder arm with protection in plexiglass

Presse avec protection en plexiglas



| MODELO/MODELE/MODELE | C 220 S C 220 SCEV | C 250 S C 250 SCEV | C 275 S - | C 300 S C 300 SCEV | - C 350 SCEV |
|--|---|------------------------------|-------------------|----------------------------------|---------------------|
| Precio Price Prix | 627 € 695 € | 666 € 729 € | 624 € - | 1.042 € 1.163 € | - 1.855 € |
| Dimens. A (mm) | 385 | 385 | 400 | 438 | 487 |
| Dimens. B (mm) | 245 | 245 | 250 | 298 | 355 |
| Dimens. C (mm) | 355 | 365 | 390 | 420 | 515 |
| Dimens. D (mm) | 425 | 475 | 685 | 520 | 685 |
| Dimens. E (mm) | 400 | 410 | 555 | 450 | 555 |
| Tensión/Frecuencia Power supply [V/Hz] Tension/Fréquence | 220/50 | | | | |
| Material Material Matériel | Estructura fundición de aluminio anodizado [C275 S aluminio lacado] Structure anodized aluminium [C275 S laquered aluminium] Structure aluminium anodisé [C275 S aluminium laqué] | | | | |
| Diámetro cuchilla Diameter slicer (mm) Diamètre lame | 220 | 250 | 275 | 300 | 350 |
| Potencia Power Puissance (W) | 170 | 190 | 150 | 250 | 400 |
| Capacidad corte (mm) Cutting capacity (±S) Épaisseur de tranches | 200 125 | 195 145 | 225 180 | 245 195 | 280 220 |





 **Infrico**

infrico.com

infrico.com

Síguenos en: [in](#) [f](#) [y](#) [i](#)

info@infrico.com

Tel: (0034) 957 51 30 68

Ctra. de Aguilar a A-318 por Moriles,

km 15,5 - A-3132

CP 14900 LUCENA, Córdoba - España